

# **TEXTILES AND DRESS DESIGNING**

**THEORY  
PRACTICAL I & II**

**VOCATIONAL EDUCATION**

**Higher Secondary - Second Year**

A Publication under  
Government of Tamilnadu  
Distribution of Free Textbook Programme  
( NOT FOR SALE )

Untouchability is a sin  
Untouchability is a crime  
Untouchability is inhuman



**TAMILNADU  
TEXTBOOK CORPORATION**  
College Road, Chennai - 600 006.

© Government of Tamilnadu  
First Edition - 2011

## **CHAIRPERSON**

**Dr. (Tmt) G. Krishna Bai,**  
Dean, Faculty of Home Science,  
Professor and Head,  
Textiles and Clothing Department  
Avinashilingam Deemed University for Women  
Coimbatore - 641 043.

## **AUTHORS**

**Dr. K. Lakshmi**  
Associate Professor,  
Department of Textiles and Clothing,  
Avinashilingam University for Women  
Coimbatore - 641 043

**Dr. N. Vasugi Raaja**  
Associate Professor  
Department of Textiles and Clothing,  
Avinashilingam University for Women  
Coimbatore - 641 043

**Dr. S. Amsamani,**  
Associate Professor,  
Department of Textiles and Clothing,  
Avinashilingam University for Women  
Coimbatore - 641 043

**M. M. Ramalakshmi**  
Post Graduate Assistant,  
Jaigopal Garodia Govt. Girls Hr. Sec. School  
Virugambakkam,  
Chennai - 600 092.

**I. Rosali Mary,**  
Vocational Teacher,  
Presentation Convent Girls Hr. Sec. School  
Coimbatore.

This book has been prepared by The Directorate of School Education  
on behalf of the Government of Tamilnadu

**This book has been printed on 60 G.S.M. Paper**

Printed by Offset at:

# CONTENTS

S.No.	PARTICULARS	Page
<b>PART - I</b>		
1	Fabric Finishes	1
2	Dyeing and Printing	7
3	Family Clothing Budget and Wardrobe planning	19
4	Selection of Clothing	26
5	Designing in Clothing	37
<b>PART - II</b>		
6	Identification of Fabrics and Preliminary Stitches in Garment Construction	54
7	Laying the Pattern, Marking and Cutting	62
8	Pattern Alteration	76
9	Belt and Bows	98
10	Garment Enrichment	105
11	Selection of Fabrics for Construction of Garments	118
<b>PART – III</b>		
12	Ready-made, Tailor-made and Home-Made Garments	134
13	Care and Maintenance of Garments	141
14	Apparel Merchandising	158
15	Role of Computer in Garment Designing	168
16	Advertisement	174
17	Entrepreneurship Development	179
<b>PRACTICALS - I</b>		
1	Magyar frock	190
2	Yoke frock	193
3	Round yoke with umbrella skirt-frock	196
4	Half skirt	199
5	Plain blouse (for skirt)	201
6	Choli	204
7	Cut choli	207
<b>PRACTICALS – II</b>		
1	Shorts	211
2	T- Shirt	215
3	Pyjama	218
4	Kalidar Kurta	220
5	Salwar	224
6	Kameez	226
7	Slack shirt	230

# 1. FABRIC FINISHES

## INTRODUCTION

A newly constructed fabric as it comes from the mill is known as greige goods or gray goods. This does not imply that the fabric is gray in colour; it simply denotes any unfinished fabric. The goods must pass through various finishing processes to make it suitable for its intended end use. Finishes may change the appearance of the fabric, its texture, its serviceability and its durability.

### 1.1 WOVEN FABRICS ARE DIVIDED INTO THREE TYPES

- Gray cloth    • Converted fabric    • Coloured woven fabric
- **Gray cloth :** The cloth, which is produced by weaving process directly without any finishing, is known as gray cloth. This cloth is made by improperly processed yarn. Only some of the gray clothes are sent to the market for sale. Other gray clothes would be finished with various processes and then sent for sale.
- **Converted fabric :** The conversion of unfinished fabric into finished fabric is known as converted fabrics.
- **Coloured woven cloth :** The coloured yarns are woven in the mill and then sent directly to the shop for sale.

### 1.2 FINISHES ARE DIVIDED INTO TWO TYPES

1.2.1 Basic finishes

1.2.2 Functional finishes

#### 1.2.1 Basic finishes

The basic finishes are further classified into two classes,

- A) Finishes that appeal to the eye
- B) Finishes that appeal to the touch

#### A) Finishes that appeal to the eye

**i) Bleaching :** If the cloth is to be finished as white or to be given surface ornamentation, all natural colours must be removed by bleaching. This is also necessary if discoloration or stains have occurred during the previous manufacturing process. Bleaching can be done in the yarn stage as well as in the constructed fabric. Suitable bleaching agents are used to remove the colour from the fabric namely oxidizing or reducing bleaches. Bleaching is done for the cotton, woollen and silk. Man-made fabrics do not need bleaching, as they are naturally white. The kind of chemical to be used depends upon the kind of textile fiber of which the fabrics is composed.

**ii) Mercerizing :** Mercerizing is an important preparatory process for cotton fabric. It is also used in the finishing of linen. The process consists of holding the fabric in tension while treating it with a strong

solution of sodium hydroxide at a temperature of 70 to 80 F. Mercerizing causes the flat, twisted, ribbon like cotton fiber to swell into a round shape and to contract in length. The fiber becomes much more lustrous than the original fiber, and its strength increased by 20%. Mercerizing is done to improve the dye pick up.

**iii) Shearing :** Pile-weave fabrics and fabrics that have been napped are usually sheared to give an attractive smooth surface to the cloth. Shearing levels all surface irregularities caused by the plucking action in the napping process. On the other hand, patterns may also be cut into the pile fabrics by shearing to give a “sculptured effect” of a design having high and low surface levels. Shearing is done by a machine which has rotating cylinders and helical blades. Its action resembles that of a lawn mover. After shearing, the fabric is automatically brushed to remove the sheared ends of the yarns.

**iv) Singeing :** Singeing is one of the first essential preparatory processes that impart smooth finish to fabric. Singeing burns off lint, threads, fuzz and fiber ends and leave an even surface before the fabric passes through other finishing processes or a printing operation. Singeing is accomplished by passing a gray goods rapidly over gas flame, usually two burners to a side, at a speed of 100 to 250 yards (90-225m) per minute. After the cloth leaves the burners it is pulled through water and then it is dried.

**v) Beetling :** Beetling is a common finishing process for linen. The yarns are flattened by the impact of wooden mallets. This hammering actually closes the weave and gives the cloth a firm, flattened, lustrous appearance. All table linens under go this process, but dress linens are never beetled. Beetling differs from calendering.

**vi) Tentering :** This process is applied at various stages of finishing. Usually, the fabric is wet when it is run into a tender. Drying and evening of the fabric width are the primary purpose of the tendering. The tender frame consists of two endless chains carried in rugged rails with a distance between them that can be adjusted. The chains are equipped with clips or pins, which grip the selvage of the fabric and carry into the heated housing where a blast of hot air removes any moisture. Pin frames are mostly used on woollen or knitted goods; clip frames are favored for cotton. The tiny holes or marks are sometimes noticeable in the selvages.

**vii) Calendering :** Calendering is essentially an ironing process that adds sheen to the fabric. The method varies according to the type of finish desired. Calenders are heavy machines made up of at least two rolls. One is usually of chilled steel; the other, a softer material like wood, paper, cotton fiber, corn husks or combinations of cotton and corn husk. The rolls are supported in vertical frames. Plain rolling calenders may have as many as seven rolls, four steel rolls and three horn husk or cotton rolls. The steel rolls may be equipped to be heated by gas or steam. The textile material is passed through the calendering machine rapidly between the gap formed by the rollers. This is done at an average rate of 150 yards (135m) per minute, and under pressure of 40 to 60 tons (550-827 MPa); the goods are then wound up on the back of the machine.

**viii) Moire finishes :** Attractive, lustrous wavy designs known as moiré can be produced by a process of minute surface embossing or pressing of a fabric with crenellated, or ridged, rollers. The best moiré results are obtained on fabrics that have rib effects in the filling. The pattern is imprinted on the raised

filling yarns by rollers. The luster is formed by the divergent reflection of light on the impressed lines of the design.

**ix) Pressing :** Mostly pressing method is used for wool fabrics to remove short hair fibers present on the surface of the fabric. This pressing method is similar to calendering.

**x) Embossing :** The process of producing raised figures or designs in relief on the surface of the fabrics by passing the cloth between heated engraved rollers is known as embossing. The process can be applied to the fabrics made of all types of fibers except the wool. To preserve the embossed finish of such fabrics, they should be washed in lukewarm water with a mild soap, never be bleached, and ironed on the wrong side while damp.

**xi) Crepe and Crinkled effect :** Permanent crepe effects are obtained by using hard twisted yarns in the weaving process. Another method imprints a crinkled effect by means of engraved rollers, but the finish disappears in repeated washing. In another finishing method, caustic soda is impressed on the cotton fabric in the form of figures or stripes and the fabric is then washed. The part imprinted with the caustic soda shrinks, and the other part puckers.

A permanent crinkle may be obtained on a fabric that can melt, such as nylon. The fabric is put through a hot roller on which there are raised figurations. The contact of the fabric against the raised hot surface helps it to melt and pucker at these points.

## **B) Finishes that appeal to touch**

Some of the changes given to the fabric for softness, weight, crispness and warmth are known as finishes that appeal to touch.

**i) Napping :** Napping is chiefly used to obtain a relatively deep hairy surface, but the degree of depth depends upon the technique used. The fabric is passed under a roller that has fine steel wires with small hooks on the ends. The hooks scrape the surface of the fabric pulling up fiber ends out of the yarn. The fuzzy finish, produced by napping makes a soft fabric that holds warmth.

**ii) Weighting :** Silk may be treated with tin salts to increase the weight of the fabric and improve its hand and drape. The weight and body of the fabric, is increased by immersing it in a solution containing metallic salts. The salts permeate the yarns and become a permanent part of the fabric but cannot be detected by handling. If excessive metallic salts are used in the weighting, it may weaken the fabric.

**iii) Starching :** Glue, wax, casein, starch and clay are used for cotton fabrics to give weight, stiffness and shiny appearance. Starch is applied on the fabric and passed between two rollers. Wax and oil are mixed together to the starch solution to give the shiny appearance to the fabric. Starching is a temporary finish.

**iv) Sanforizing :** Fibers spun into yarn are under constant tension during the weaving process. The yarns are made to assume a final condition by shrinking the fabric in a preparatory finishing process that minimizes subsequent shrinkage such as immersion in cold water. The factors that control the shrinkage are the stability of the fiber and the construction of the fabric. Construction is based on the type of the weave, the yarn twist and the yarn count.

The piece of fabric is taken and measured and then immersed in the water and the shrinkage of the fabric is calculated. Then the fabric is passed through the machine to make it shrink as to a desired measurement. This is known as sanforizing.

### 1.2.2 Functional finishes

Special finishes imparted to fabrics, keeping the functional use of the fabric is known as special or functional finishes.

**a) Absorbency finish :** Although the cellulose fibers like cotton, linen and rayon have good absorbency, sometimes it is desired that they should be more absorbent. Appropriate application of ammonium compounds modifies the cellulose to become more absorbent, providing greater comfort and usefulness for such uses as undergarments and towels.

**b) Wrinkle resistant finish :** These finishes are also sometimes referred to as “crease-resistant” or “Wash and wear” finishes. DMDHEU namely Dimethyl Dihydroxy Ethylene Urea is used to impart wrinkle resistant finish on the textiles. The purpose of this finish is to prevent deformation of the fabric by undesirable and unintentionally introduced folds and rumples. Some finishes are more wrinkle-resistant than others, but fabrics treated with any of these finishes tend to smooth out when properly hung after wearing.

**c) Flame retardant finish :** A wide variety of flame retardant chemical finishes have been developed for application to fibers and fabrics. Carbonate and ammonium salts are used for flame retardant finish.

**d) Antibacterial finish :** Chemical antiseptic finishes using Chitosan, impart a self-sterilizing quality to a fabric. The appearance and the feel of the fabric does not change and no chemical odour remains. Dry cleaning does not impair the finish.

**e) Prevention of mildew :** Cellulose fibers are particularly susceptible to mildew. Silk and wool are also susceptible, but to a lesser extent. Such untreated fabrics will become stained, malodorous and eventually deteriorated by the fungus if allowed to remain in a moist condition for a period of time.

Shower curtains or other fabrics may be mildew proofed at home by soaking the material in soapy water, then, without rinsing, dipping it into a solution of boric acid and carbolic acid, which prevents rapid growth of the mildew fungus. The most effective mildew proofing agent is 0.05 per cent solution of phenyl mercuric acetate in water.

**f) Water repellent finish :** The fibres in the fabrics become covered with a film of synthetic resin. This repels and delays adsorption and penetration of water through the fabric. This finish allow air to permeate the fabric, and its comfort is largely retained in contrast with the water proof finishes.

Most of the original water proof finishes, produced by the application of rubber, waxes and oxidised oils, have been replaced by applying impervious films of polyvinyl chloride - PVC plastic. The low cost of this type of application, associated with the very light weight of the water proof fabric produced, compensates for the lack of comfort in the garment produced.

**g) Waterproof finish :** For a fabric to be truly waterproof, it must be completely sealed with a substance that is insoluble in water. Modern waterproofing materials include the vinyl resins, which do not oxidize and crack as readily as rubber.

## CONCLUSION

Textile Finishes enhance the feel and drape of fabrics involve the addition of sizing, weighting, fulling, and softening agents, which may be either temporary or permanent. Thus finishing is used to improve the serviceability and durability.

## QUESTIONS

### I. Fill in the Blanks

1. Finishes may change the \_\_\_\_\_ of the fabric.  
a) Appearance      b) Twist      c) Synthetic      d) Both A and B
2. \_\_\_\_\_ Fabrics need bleaching  
a) Natural      b) Man-made      c) Synthetic      d) Polyester
3. Mercerizing is an important preparatory process for \_\_\_\_\_ fabric  
a) Silk      b) Nylon      c) Rayon      d) Cotton
4. Mildew finish is given to prevent the growth of \_\_\_\_\_  
a) Virus      b) Bacteria      c) Fungus      d) Wash and Wear
5. The prevention of water absorbancy by the fabric is \_\_\_\_\_  
a) Water repellent      b) water proof      c) Wrinkle resistance      d) Wash and wear

### II. Write Short answers

1. Define gray cloth.
2. Define converted fabric.
3. Explain embossing.
4. Define water proof.
5. What is anti-bacterial finish?
6. Define sanforizing.
7. What is meant by napping?
8. Write the purpose of beetling finish.



### **III. Give brief answers**

1. Bring out the purpose of fabric finishes.
2. Explain bleaching and mercerizing.
3. Write short notes on singeing, tentering and embossing.
4. Explain napping and weighting.
5. Write notes on prevention of mildew and wrinkle resistant finish.
6. Explain briefly about flame retardant finish.

### **IV. Give detailed answers**

1. Account for the finishes that are appealing to eye.
2. Explain finishes that appeal to touch.

### **Answers**

#### **I. Fill in the Blanks**

1. (a)            2. (a)            3. (d)            4. (c)            5. (d)

## 2. DYEING AND PRINTING

### INTRODUCTION

Dyeing and printing are finishing processes that provide lasting beauty and delight to the textile fabrics by adding colour. Dyeing and printing differs in the method by which colour is applied to the fabric. In the dyeing process; fibre, yarn or fabric is impregnated with a dyestuff. In printing, a pattern or a design is generally imprinted on the fabric in one or more colours by using dyes in paste form.

### 2.1. CLASSIFICATION OF DYES

Dyes are classified as Natural and Synthetic dyes.

#### A). Natural Dyes

Natural dyes are taken from three sources namely plants, animals and minerals.

- **Vegetable Dyes :** Around 4000 years back Egyptians have used Indigo dyes, that are obtained from stems and leaves of a particular plant. Alizarin dyes are taken from roots of madder plant. Logwood dyes are extracted from the trees which give black colour to silk and cotton fabrics.
- **Animal Dyes :** Cochineal dye was extracted from an insect - Coccus Cacti. The dye was taken after killing the female insects. These dyes were used for imparting red and orange colours in silk and wool fabrics. Tyrian purple dye was made out of shell fish.
- **Mineral Dyes :** Natural minerals yield certain varieties of dyes for example Iron Buff.

#### B). Synthetic Dyes

Synthetic dyes were first derived from coal tar in 1856. Later innumerable dye compounds were made from coal tar, and are constantly being improved as to beauty of colour and colourfastness. They are as follows :

- **Direct Dye or Salt Dye :** Direct dye can be applied to animal as well as vegetable fabrics but are generally applied to cotton and are known as direct cotton dye. These dyes are soluble in water and are chiefly composed of amines and phenols. Because a little salt is added to the solution while dyeing with direct dyes, these are also called salt dyes. A further treatment with acetic acid and sodium dichromate is necessary to make them fast to washing. The dye colours often have only fair fastness to light, poor fastness to washing and are not very bright.
- **Basic Dyes :** The first coal-tar dye was a so-called basic dye. Basic dyes are salts of organic colour bases. It was developed to give many bright shades of silk and wool. Basic dyes are otherwise known as cationic dyes, the same are used with a mordant, Tannic acid, for cotton, linen, acetate, nylon, polyester and acrylics. This dye gives beautiful colour but is not fast to sunlight, washing and perspiration.
- **Acid (Anionic) Dyes :** Acid dyes are the sodium or calcium salts of colour organic acids. They are used mostly on wool and silk. Acid dyes are inexpensive and fairly fast to light, but they are not fast to washing. Soap containing alkali if used will change the colour.
- **Mordant or Chrome Dyes :** Sodium or Potassium dichromate mordant is added in the dye bath. This mordant along with dyes will penetrate into the fabric. These are used to dye wool and also for printing cotton. These are fast to light, washing and perspiration.

- **Developed Dyes :** This process requires a base to be dyed on the goods. This is followed by a diazotizing process, whereby the dye is chemically changed and treated with a fresh set of chemicals, called developers, that form the completed dye. Developed dyes are fairly fast to washing because they have been literally built into the fibre.
- **Sulphur Dyes :** Sulphur dyes, first made in 1879, are used for cotton and linen. Sulphur dyes are insoluble in water and must be made soluble with the aid of caustic soda and sodium sulphide. These dyes are fast to washing, light and perspiration, but excessive chlorine will strip the colour.
- **Vat Dyes :** The first vat dye was an Indigo created in 1879. Vat dyes are the fastest dyes for cotton, linen and rayon. Vat dyes are resistant to light, acids, alkali as well as to oxidizing bleaches. Vat dyes are insoluble pigments, but are made soluble in water by the use of a strong reducing agent, such as hydrosulphite developed in the alkali sodium hydroxide. The fabric is immersed in this solution. Subsequent exposure to air or immersion in an oxidizing bath (bichromate) restores the dye to its insoluble form as a part of the fibre.
- **Reactive Dyes :** Reactive dyes were developed in 1957. These dyes react with fibre molecules to form a chemical compound. These dyes were first designed for cellulose fibres, now available for wool, silk, nylon, acrylics and blends of these fibres. Advantages of reactive dyes are their excellent fastness to light and washing. They give very deep and brilliant colours.
- **Pigment Dyes :** Pigment dyes are not true dyes because they have no affinity for the fibre and if applied and held to the fabric with resins, which are then cured at high temperature. The colours, confined to light shades, bright colours, such as metallic colours as gold are usually applied to cotton cloth but are also used in fabrics of wool and manmade fibres.
- **Optical Brighteners (Colourless Dyes) :** These so-called dyes are also called fluorescent whiteners or optical brighteners. The whiteness is really caused by absorption of ultraviolet light and reflection of visible blue light. Optical brighteners are available for cotton, acrylics, wool, acetate and nylon. They may be applied during bleaching, before resin finishing or with the resin.

### 2.1.1. Different Stages of Dyeing Textiles

Textiles may be dyed at any stage of their development from fibre into fabric or certain garments by the following methods;

- **Stock Dyeing :** Stock dyeing refers to dyeing staple fibres before they are spun. Here the packed fibres are removed from the bales and then packed in large vats to be circulated with dye liquor at elevated temperature.

In stock dyeing, which is the most effective and expensive method of dyeing, the colour is well penetrated into the fibres and does not crack readily. Stock dyed fibres does not spin as readily as undyed fibre because it loses some of its flexibility, but lubricants added in the final stage overcome most of this difficulty.

- **Top dyeing :** Top dyeing is adopted in the worsted industry. Top is wool that has been combed to take out the short fabrics, in a rope like form about 1¼ inches (30mm thick). The top is then wound on perforated spools and the dye liquor is circulated through it. Perfect even dyeing is possible in this method.

- **Yarn Dyeing** : Dyeing done at yarn stage is known as yarn dyeing. Yarn dyed fabrics are usually deeper and richer in colour. The primary reason for dyeing in the yarn form is to create interesting checks, stripes and plaids with different coloured yarns in the weaving process. Chambrays, for example, are usually woven with a coloured warp and white filling. Other examples are checked gingham, shepherds check, plaid and seer sucker.

- **Piece Dyeing** : Bulk of fabrics are dyed in this method. Piece dyeing is thoroughly satisfactory as regards evenness, penetration and overall fastness.

Fabrics may be piece dyed whether it is composed of only one kind of fibre or yarn or blends of different fibres or combinations of different yarns. When the fabric is made of one kind of fibre or yarn, the dyeing is not complicated because the one appropriate dye is used. If the fabric is of a blend or combination of different yarns, then special procedures are required where different dyes that are particular for each fibre need to be selected. They are union dyeing and cross dyeing.

**a) Union Dyeing:** Different fibres may require different dyes to obtain the colour, this may be done by putting the appropriate colour dye that is specific to each type of fibre into one bath.

**b) Cross Dyeing:** Cross dyeing of goods may be accomplished in any one of the several ways. One method is a combination of stock dyeing or of yarn dyeing with subsequent fabric dyeing.

- **Solution pigmentation or Dope dyeing** : A process called solution pigmentation or dope dyeing has been used for manmade fabrics ranging from rayon through saran and glass fibres. In dope dyeing, dye is added to the spinning solution before it is extruded through the spinnerets into filaments. This method also gives a greater degree of colourfastness. Effective results have been obtained by this method.

- **Garment Dyeing** : Certain kinds of non-tailored apparel, such as hosiery, pantyhose and sweaters can be dyed as completed garments. A number of garments are loosely packed into a large nylon net bag. The bags are then put into a puddle dyer, which is a tub with a motor-driven puddle that agitates the dye bath. Garment dyeing is an economical method.

- **Resist Dyeing** : Resist dyeing can be done either in garments or fabrics.

Resist dyeing is a term for a number of traditional methods of dyeing textiles with patterns. Methods are used to “resist” or prevent the dye from reaching all the cloth, thereby creating a pattern and ground. The most common forms use wax, some type of paste, or a mechanical resist that manipulates the cloth such as tying or stitching. Another form of resist involves using a chemical agent in a specific type of dye that will repel another type of dye printed over the top. The most well-known varieties today include tie-dye and batik.

- **Tie and Dye** : Tie-dye is a process of resist dyeing textiles or clothing which is made from knit or woven fabric, usually cotton, typically using bright colors. Tie and dye developed especially in the regions of Gujarat and Rajasthan. People of Jaipur are particularly skilled in this craft. Tie-dyeing is accomplished by folding the material into a pattern, and binding it with string or rubber bands. Many different kinds of dyes can be used, mostly reactive dyes are used.

Tie dye is a technique for dyeing fabrics that results in interesting, colorful patterns. The technique involves crumpling, pleating or folding the fabric into various patterns, then tying it with string, hence the name “tie and dye”. The tied fabric is dipped into vats of dye, then wrung out and rinsed. The ties

prevent the entire material from being dyed. Designs are formed by applying different colors of dyes to different sections of the wet fabric. Tied areas accept dye unevenly amidst the folds, creating varied patterns in the finished product.

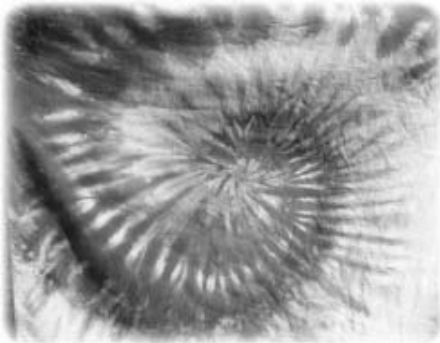
There are different types of methods of tying threads to obtain different patterns such as: Striped design – diagonal, vertical and horizontal stripes, Knotting, Circular design, Marbling, Rouching, All over tiny dots, Mango design and Flower design.



**Tied Fabrics**



**Dyeing**



**Tie and Dye Fabric**



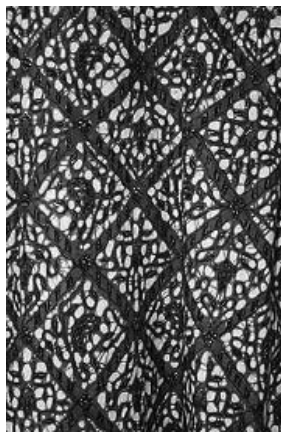
**Tie and Dye T-Shirt**

**Batik :** This is another form of resist dyeing which produces patterns like prints. The difference between ‘tie and dye’ and ‘batik’ lies in the fact that former is by tying the spots and latter applying wax on the cloth. The word ‘batik’ origin is Javanese, meaning ‘to tattoo’ . The fabric used for batik should be smooth and thin in order to get a good effect. Silk is perhaps the easiest fabric of all to use. Other fabrics suitable for this are soft cotton and organdie. Any fabric for making batik should be thoroughly washed and ironed before use.

Design is traced lightly to the fabric with sharp pencil. Brushes of various sizes will be needed to apply hot liquid wax on the design. Bees wax is the best wax to use for batik. Then the fabric is dyed. The wax prevents the dye to from penetrating into the design. The finished fabric is left with a white pattern on a coloured background. The wax is sometimes deliberately cracked to form a fine spider-like line of colour where the dye penetrates these cracks.



**Hand made Batik**



**Batik Dyed Fabric**



**Batik curtain**

## 2.2. PRINTING

Printing produces colourful effect on the fabrics Printing is application of colour in the form of a design. Printing can be done by hand or machine. The dyes used in printing are in the form of pastes.

### 2.2.1. Types of printing : Printing has been divided into,

- A) Hand printing                      B) Machine printing

#### A) Hand printing

• **Block Printing** : Block printing was practiced by Chinese and Indians some two thousand years ago. Blocks are made of wood or wood and lino. The design is carved on line which is generally cut to a thickness of  $\frac{1}{4}$  inch. This cut piece of lino is struck to wooden piece of the same size. Many printers use only wooden blocks on which the design has been carved. These blocks are dipped in paste of colour and then pressed on the fabric, so that coloured pattern is produced on the fabric. First a block carrying the paste of one colour is stamped on the fabric and allowed to dry. Then another block carrying the paste of different colour is stamped over it to form the multi-coloured patterns. The process is repeated over the entire fabric surface to be printed.

It is a slow and costly process, uniform pressure is needed to transfer the colour. The intensity of colour cannot be uniform throughout.

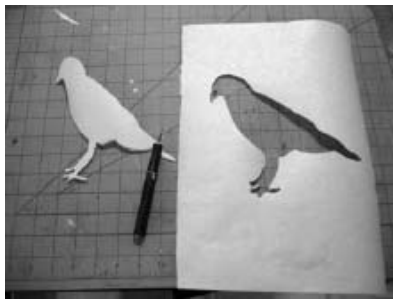


**Wooden Blocks**



**Printed Design**

• **Stencil Printing** : Stencil printing originated in Japan. Its high cost limits its use and importance. In this, printing, the design must be first cut in cardboard, wood or metal. The stencil may have a fine delicate design, or there may be large spaces through which a great amount of colour may be applied. A stencil design is usually limited to the application of one or two colours and generally used for narrow width of fabric like block printing. This method is very slow.



**Design cut on Card board**



**Design on fabric**



**Printed design**

• **Screen Printing** : Originally, this technique was referred to as silk screen printing because the screens were made of fine, strong silk thread. Today they are also made of nylon, polyester, vinyl and metal. Screen printing is done with the use of either flat or cylindrical screens.

Each screen design may be drawn by hand and a coating of lacquer or other impermeable substance applied to all parts of the screen that are not part of its design. Today the design is photographed and a negative is used for each sensitized screen to opaque or block out, those areas not part of the screen's colour design. Each screen is then fitted into a wooden or metal frame.

The printing paste or dye is poured on the screen and forced through its unblocked areas onto the fabric with a rubber-edged squeegee. The frame is then raised and placed on the next section of the fabric and the operation is repeated until the entire length of the cloth is printed with that particular colour. This process must be repeated for each colour to be used in the design.

The hand screen printing is time-consuming and limited to relatively short lengths of 60 yards (58m) of fabric. Electronically controlled automatic machines can screen print long lengths of cloth at rates of up to 450 yards (400m) per hour.



**Screens**



**Printed Design**

## **B) Machine Printing**

Machine printing includes Direct Roller printing, Duplex printing, discharge printing, resist printing, pigment printing, transfer printing, photo printing and flock printing.

• **Direct Roller Printing** : Roller printing was developed in 1785. Thousands of yards of coloured designed fabrics are produced in an hour by this method of printing.

In this printing, several copper cylinders or rollers are engraved with design. Engraving the designs on the rollers is a hard and careful work lasting many days, but actual printing by this method takes very little time.

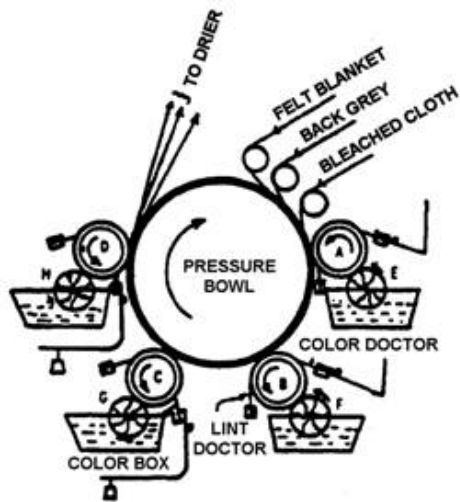
The roller is as wide as the cloth. The numbers of rollers required depends on the number of colours used in the design. One roller prints one colour only.

The roller printing machine comprises of a large central cylinder around which passes the fabric to be printed, this cylinder rotates with the moving fabric. Number of colour printing rollers, carrying different colours, press against the fabric and the central cylinder. Thus if there are five colours in the design there are five colour printing rollers. Each of these rollers is made of copper and engraved with the respective design. Furnished rollers which move at intervals, containing the colour or dye are placed close to the design rollers. The dye is absorbed by the brush like surface and transferred to the design engraved rollers.

Next to the design roller is a big iron cylinder or roller around which the cloth is drawn as it is printed. The cloth to be printed needs a rubberized blanket (for padding) and grey cloth pass between the engraved rollers and the cylinder. The blanket gives a good surface for sharp printing and the grey cloth protects the blanket besides absorbing the excess dye.

Printing machines of this kind can be provided with up to fourteen rollers, as they are able to produce patterns in fourteen colours. The roller printing machine prints only on one side of the fabric.



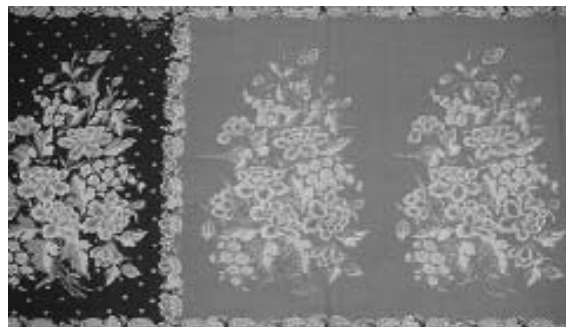


**Roller Printing Technique**



**Printed Cloth with Roller Machine**

• **Duplex Printing** : In Duplex printing, the printing is done on both the sides. The fabric may be passed through the roller printing machine in separate operations. This printing forms clear outline on both sides of fabric.



**Printed Design**

• **Discharge Printing** : This type of printing is suitable for fabrics with dark backgrounds. The fabric is first dyed. A discharge paste which contains chemicals to remove the colour is then printed on the fabric, to produce a white pattern on a ground colour. This print is done on materials like cotton and rayon.



**Roller Printing Machine**



**Printed Design**

- **Resist Printing :** This is just the opposite of discharge printing. In this type of printing, resist paste is printed first on the white fabric, and the fabric is then piece dyed. The resist materials used are resins, or clay or gum. It is put in a patterned form on fabric and is subsequently immersed in dye. The dye will affect only the parts that are not covered by the resist paste. The places where resist material has been put remain undyed. After fabric has been passed through subsequent dyeing processes, the resist paste is removed, leaving a pattern on dark background.

- **Pigment Printing :** In this, dyes used are insoluble in water and very fast to light. These pigments are made into colour printing paste, using various ingredients especially resin to act as binder and the pigment to the printed fabric.



**Printing machine**



**Printed Design**

- **Transfer Printing :** In this process, certain substances can be made to pass from a solid state directly to a vapour state when heated and return directly to a solid when cooled. The design is printed to a paper, which is fed into a machine. This is brought into contact with heat zone, which vapourizes the dye on the paper. Thus the dye is absorbed by the fabric.



**Printing Machine**



**Printed Design**

- **Photo Printing :** In this type, the fabric is coated with a chemical that is sensitive to light. The negative of the design is put against the fabric surface and the light is made to fall on it. The design on the negative gets printed on the fabric. The fabric is then washed. Black and white designs and coloured designs can be printed on the fabric.



**Photo Printing Machine with Design**

• **Flock Printing :** This is a technique of adhering minute pieces of fibre, called flock, to form design on fabrics. Using a suitable adhesive, a design is roller printed onto the fabric. Then flock of cotton, wool, viscose rayon, nylon or acrylic are applied to the fabric in a manner that causes it to adhere in an upright position and produce a pile like, velvet – textured design.



**Flock Printing Machine**



**Flock Printed Fabric**

## CONCLUSION

Thus dyeing and printing methods are adopted to enhance the beauty of the textile materials.

## QUESTIONS

### I. Choose the correct answer

1. Around 4000 years back Egyptians had used  
a) Logwood dyes    b) Indigo dyes    c) Tyrian purple    d) Mineral dye
2. Cochineal dye was extracted from an  
a) Insect    b) Alizarin    c) Synthetic chemical    d) Chrome
3. Mordant dye is otherwise known as  
a) Direct dye    b) Salt dye    c) Chrome dye    d) Vat dye
4. Stock dyeing is done at  
a) Yarn stage    b) Fibre stage    c) Fabric stage    d) Garment stage
5. Blocks for printing are made of  
a) Wood    b) Metal    c) Rubber    d) None
6. Stencil printing originated in  
a) China    b) Java    c) India    d) Japan
7. Originally screen printing technique was referred to as  
a) Silk screen printing    b) Nylon screen printing  
c) Polyester screen printing    d) Vinyon screen printing.
8. Thousands of yards of coloured designed fabrics are produced in an hour by this method of printing  
a) Block    b) Direct roller printing    c) Hand screen printing    d) None
9. This type of printing produces white designs on dark background.  
a) Block    b) Roller    c) Flock    d) Discharge
10. In this printing, design on the negative gets printed on the fabric  
a) Photo printing    b) Flock printing    c) Resist printing    d) All the three

### II. Fill in the blanks

1. Dyeing is a method where the fabric is impregnated with a \_\_\_\_\_
2. When design is imprinted on material it is known as \_\_\_\_\_
3. Natural dyes are taken from \_\_\_\_\_ sources
4. Direct dye is otherwise known as \_\_\_\_\_ dye
5. The first coal-tar dye was a so called \_\_\_\_\_ dye
6. Mordant dye is otherwise known as \_\_\_\_\_ dye
7. Block printing is a \_\_\_\_\_ printing technique.
8. Resist printing is just the opposite of \_\_\_\_\_ printing.

9. This is a technique of adhering minute pieces of fibre to form design on fabrics called \_\_\_\_\_ printing.

### III. Write Short answers

1. Explain block printing method
2. Write about vegetable dyes
3. List the stages of dyeing textiles
4. How is Top dyeing carried out?
5. What is solution pigmenting or dope dyeing?
6. Write about mordant dyes
7. Explain Duplex printing method
8. How is Transfer printing done?
9. List atleast five machine printing methods
10. How is Flock printing done?

### III. Give brief answers

1. How are dyes classified? Explain about natural dyes.
2. Write about any two synthetic dyes
3. How is yarn dyeing carried out?
4. Write about screen printing techniques
5. How is roller printing done on textile fabrics.

### IV. Give detailed questions

1. Differentiate dyeing and printing. Classify dyes and explain natural dyes and any five synthetic dyes.
2. Give an account of the dyes suitable for dyeing cotton fabrics.
3. How are Textiles dyed at various stages?
4. Explain in detail the hand printing techniques.
5. Give an account of machine printing techniques?

### Answers

#### I. Choose the correct answer

- |      |      |      |      |       |
|------|------|------|------|-------|
| 1. b | 2. a | 3. c | 4. b | 5. a  |
| 6. d | 7. a | 8. b | 9. d | 10. a |

#### II. Fill in the blanks

- |              |             |                    |              |          |
|--------------|-------------|--------------------|--------------|----------|
| 1. dyestuff  | 2. printing | 3. natural sources | 4. salt dye  |          |
| 5. synthetic | 6. chrome   | 7. hand            | 8. discharge | 9. flock |

## 3. FAMILY CLOTHING BUDGET AND WARDROBE PLANNING

### INTRODUCTION

Clothing is an essential part of any annual family budget. The family budget is really nothing more than a listing of the expenses and incoming moneys on month to month basis. In budgeting one must consider the size of the family, its income, the needs of the family and the locality where the family lives. For a budget to be workable, income should be adequate enough to meet the prioritized needs of the family. Anyone can put together a basic wardrobe even on a limited budget. By shopping for and selecting certain classic pieces, we can have an all purpose, stylish wardrobe that will suit all our fashion needs.

### 3.1 BUDGET

A budget (from old French bougette, purse) is generally a list of all planned expenses and revenues. It is a plan for saving and spending. A budget is an important concept in microeconomics, which uses a budget line to illustrate the trade-offs between two or more goods. In other terms, a budget is an organizational plan stated in monetary terms.

#### 3.1.1. Definition of a family budget

A family budget is the main tool used to manage personal finances and save money. A family budget can be simple or detailed, depending on ones need for track ones income and expenses for an entire month to make a family budget.

#### 3.1.2. Benefits of budget

Budget plan helps one to achieve ones spending and financial goals, other benefits are as follows

- **Keeping Track :** Budgeting allows one to track ones monthly expenditures so that one can plan key savings strategies for important short- and long-term goals.
- **Limits one's spending :** A budget will identify expenses that can be cut so that one can set goals on making important long-term savings.
- **Discipline oneself :** Ones goal is to rid oneself of instant gratification (the symptom of credit card use). The budget sets guidelines on what and when items can be purchased.
- **Setting Goals :** Budgeting supports ones financial goals, which may include: saving for one's first home, paying down debt, preparing to go to school, planning for retirement

Good budgeting skills add these goals into the budget.

#### 3.1.3. Family expenses (annual or monthly)

In budget "cash in-flows" needs to be greater than "cash out-flows"

This section allows one to input either monthly or annual family expenses in each of fourteen different categories including: food, alcoholic beverages, housing, clothing, transportation, healthcare, entertainment, personal care, reading, education, smoking or tobacco, other expenses, contributions, insurance and pensions.

### 3.1.4. Budget planning

• **Overview :** Sitting down and making a family budget may not be the most fun activity one ever do. However, the effort and thought one put into ones budget can help relieve stress and enable one to manage ones money more efficiently. Learning to budget for one family of four is the first step toward smart financial management. If one have attempted family budgeting before but have experienced difficulty staying on track, try once more to set one family on the right financial path.

**Step 1 :** List one fixed monthly expenses. Include mortgage or rent payments, electricity, cable, food, phone, insurance, loan payments and transportation costs. If our children are in child care or a private school, add those costs as well. To ensure accuracy, use past bank statements to make a complete list.

**Step 2 :** Look through one's past 12 months of expenses. Write down any expenses that are paid annually. Magazine subscriptions, pest control fees, car registration fees, membership dues and school supplies for children and other such expenses. Add these together and divide by 12 to obtain the average monthly cost of these annual fixed expenses. List this result on one's monthly budget sheet.

**Step 3 :** Write down one variable monthly expenses on one sheet. List the cost of clothing, entertainment, restaurant meals and other variable expenses for both adults and children. Remember to look over the past year and include expenses that do not occur every month, such as school lab fees, sports or music lessons, and the purchasing of gifts.

**Step 4 :** Compare the total monthly expenses to monthly take-home income. Note whether the expenses are greater or less than the income. Examine each budgeted category and decide if one needs to reduce that expense. Involve children in the discussion if they are old enough.

**Step 5 :** Rewrite monthly budget with adjusted figures. Prepare for unexpected expenses by setting up an automatic transfer system with one bank to establish or build a savings account. Budgeting helps establish the habit of saving money. Encourage children to save part of any money that they receive.

**Step 6 :** Decide the person responsible for keeping track of monthly budget. Rotate the responsibilities occasionally to ensure that both of them understands the income and expenditure pattern, frequent communication will enlighten the budget plan.

**Step 7 :** Set up an envelope system to break any credit card habit one may have. Commit to paying cash for as many expenses as possible. Pay the fixed expenses before calculating how much money one have left for variable expenses. Put the budgeted amount of cash in an envelope designated for each variable category expense, such as entertainment, clothes, restaurant meals, coffee and gifts. Once the money in that envelope is gone, do not make any additional purchases for the month in that category.

• **Tips and Warnings :** Use budgeting software to streamline the process. Consider automating loan payments through the financial institution. Stop using credit cards and pay off any outstanding balances. Establish savings accounts for children. Open a vacation or holiday fund to help save for those expenses. Consult with a trusted friend or adviser concerning any financial difficulties. Beware of consolidation loans if one has credit card debt. Analyze any fees and expenses associated with savings plans.

### 3.1.5. Clothing budget for a family

Clothing the family can be an expensive endeavor, especially with the growth spurts that children go through so often when they are younger.

Restrict oneself from impulse buying. Hold oneself to the rule of buying clothes only if one or one family absolutely needs them. Purchase new items of clothing, wisely. It is best to invest in a few staple pieces that match existing pieces in one's wardrobe and can be worn in a variety of styles.

Take advantage of end-of-season clearance and buy out specials, especially on big ticket items such as winter coats. One can easily find discounts of 75% or more on winter clothing at the end of March or April, and summer clothing at the beginning of August and September. This can be a bit trickier for younger children because they outgrow things so quickly, but for teenagers and older children one can find significant savings.

Consider setting up a schedule for purchasing new clothes, and make sure children are aware of the new ruling. It makes sense to shop in the late summer for new school clothes and proper fitting shoes for the fall- repeat the process in the spring. Before going shopping for new clothes, have one family go through their closets and remove clothing that they no longer wear or outgrown.

Creative thinking and flexibility are the keys to keeping one family budget intact. These tips will help one stick to a strict clothing budget and save money for more important things. And with a family- there is always something (or someone) that needs money!

### 3.1.6. Clothing expenditures for the family

The family consists of the father, the mother, and the two children sixteen years, and eleven. The father sets aside part of his income for life insurance and savings with the hope that he is providing for future emergencies. Because well-balanced meals are required for health and physical growth, a large part of the family's income must be spent for food.

In addition there are such items as operating expenses for the home, church/temple and charity contributions, doctor's bills, recreation, and education which a normal family included in its spending. If these are provided for, this family on a moderate income cannot afford to spend more than approximately eight to ten percent, on clothes. In some instances the father spends more for clothes than the mother. In others the reverse is true. In this case let us assume that the mother spends more. Most girls of high-school age need more clothes than boys of eleven.

### 3.1.7. The divisions of a clothing budget

The largest division of the budget is outer clothing, which includes wraps and dresses. Shoes and hose generally rank next. This is not difficult to understand at a time when stockings are so sheer that they do not last long. The following figures compiled from the clothing expenditures of several hundred higher secondary school girls show one how the expenditures may vary in the different divisions of the clothing budget:

		<b>Per cent</b>
Outer garments	-----	48 to 54
Undergarments and sleeping garments	-----	8 to 13
Shoes and hose	-----	18 to 27



Accessories	-----	4 to 8
Sport clothes	-----	0 to 4

^ Determine the percentages of ones own wardrobe costs and see how they compare with the ranges shown above.

### 3.2 WARDROBE

A wardrobe, also known as an armoire from the French, is a standing closet used for storing clothes. The earliest wardrobe was a chest, and it was not until some degree of luxury was attained in regal palaces and the castles of powerful nobles that separate accommodation was provided for the apparel of the great. The name of wardrobe was then given to a room in which the wall-space was filled with cupboards and lockers, the drawer being a comparatively modern invention. From these cupboards and lockers the modern wardrobe, with its hanging spaces, sliding shelves and drawers, evolved slowly.

**3.2.1. Wardrobe planning :** The purpose of wardrobe planning is twofold: first, to create a list of outfits that quickly allows one to pick ones clothes for the day with a minimum of effort and second, to invent ones wardrobe to be able to eliminate unnecessary items and to more easily purchase items missing from the wardrobe. This process can be fairly time-consuming but one will find that this one-time investment of a few hours will pay off enormous dividends in time, money and sanity.

**Part 1: Wardrobe Inventory :** The first phase is to pare down ones wardrobe. Open ones closet and drawers, take each item that one haven't worn in a year and place it in a box. Don't think about it – just do it. These are probably things one don't need but we'll deal with them later. Now, see what one have left. First separate clothes into casual pieces and work pieces and then hang like clothes together (skirts, pants, jackets, etc). Now hang similar colored clothing together and then use the Wardrobe Inventory to list the items in ones wardrobe. When creating the inventory, describe the clothing items one know exactly which piece one're referring to. For example, if one have several white shirts, indicate if they're long or short sleeved and any other unique characteristics. Also, indicate what shade of color a particular item is so one know if the blouse is navy or pale blue. The idea is for one to be able to select an outfit and immediately be able to pick the items from the closet.

**Part 2: Creating the Outfit List :** Using the components in the Wardrobe Inventory, make a list of the outfits one have. Organize the Outfit list in any manner that makes sense to one but it might be easier to start with one item (like ones navy skirt) and build every outfit one can think of around that skirt.

**Part 3: Wrap-Up and Future Steps :** Once one're done with the Outfit List it can either be typed up or re-written if necessary to make it more organized. Then post the list inside the closet door or someplace that's easily accessible.

When one have some time, go ahead and create those new outfits and add them to ones. Be sure, however, to create a new outfit with any new clothes one buy and add it to ones list. And, when shopping clothes, buy items that will build a new outfit rather than end up unworn in the back of the closet.

**'Think of your wardrobe as a Collection'**

## Men's wardrobe



## Women's wardrobe



### 3.3 USE THE INFORMATION BELOW TO GUIDE YOUR PLANNING AND SHOPPING

- **Underwear :** It is essential that the bra and underwear fit well for the wearer. A professionally fitted bra will make a huge difference to how well ones clothes fit. Underwear that is too small or poor fitting will create bulges under the clothing.
- **Colour :** Limiting the colour palette to one's wardrobe to 3 or 4 main colours will add sophistication to ones look and make clothing easier to combine. Only purchase clothing in colours that flatter your skin, hair and eye colours - if you're finding it difficult to determine which colours suit you best, consider obtaining professional advice from a colour consultant. Before buying, check how potential purchases look on you under natural lighting if possible, as store lighting can be deceptive.

• **Layering** : Layering pieces and accessories bring your wardrobe to life. For example, a white shirt on its own is simple and elegant but lacks personality - adding texture using pieces such as a vest, a waist belt, or beautiful statement necklace will create your individual style. Layering short sleeve and long sleeve tops under short sleeve/sleeveless tops and dresses creates different looks and extends your wardrobe.

• **Tips for Shopping**

- Go shopping with a list of pieces to purchase that will enhance your existing wardrobe and stick to it
- Consider taking some of your own pieces (including shoes and accessories if necessary) with you to try with potential purchases
- Check clothing colours in natural lighting if at all possible
- Check store return policies before you buy
- Wear clothing that is easy to change out of
- Only shop with friends and family whose style you admire
- Remember that store lighting, mirrors and sales staff can be deceptive!
- If it doesn't make you look and feel wonderful and combine with at least 3 other pieces in your wardrobe, put it back

• **Fashion** : Use seasonal trend pieces to give your wardrobe a lift and further increase the possible combinations. It's difficult to create a workable wardrobe around fashion items only, and can leave you with an 'I've got nothing to wear' feeling.

• **Care** : A key idea is to start thinking of your wardrobe as a collection - and treat it well. Appropriately cleaned, ironed, repaired (professionally when necessary) and correctly hung clothing will last longer and give you greater pleasure. If you are machine washing fine gauge clothes that don't require drycleaning or handwashing, use lingerie wash-bags (with clothing turned inside-out) on delicate machine cycle, as this will reduce pilling and stretching.

• **Storage** : Consider having your wardrobe space re-designed to correctly store your clothing. This will prevent crushing, exposure to dust and grime, and susceptibility to mildew and moths. If this is not possible consider changing to wooden hangers and specialty hangers that provide correct support without causing damage.

**CONCLUSION**

Every member must also know how the family income is budgeted. Through budgeting, family members learn to spend money wisely, thus, saving money which could be used for other family needs. Resources such as time, energy, and utilities are also used well when income is budgeted. Every family member has different clothing needs. His/Her activities and family status in the family must be considered.

**QUESTIONS**

**I. Fill in the Blanks**

1. Budget is generally a list of all planned \_\_\_\_\_ and revenues
2. Family budget is the main tool used to manage \_\_\_\_\_ and save money.

3. Budgeting allows one to track ones \_\_\_\_\_ for their goals.
4. Budgeting helps establish the habit of \_\_\_\_\_
5. \_\_\_\_\_ supports ones financial goals
6. \_\_\_\_\_ and flexibility are the keys to keeping one family budget intact
7. The largest division of the budget is outer clothing, which includes \_\_\_\_\_ and \_\_\_\_\_
8. Wardrobe is a standing closet used for \_\_\_\_\_
9. \_\_\_\_\_ that is too small or poor fitting will create bulges under the clothing
10. \_\_\_\_\_ and \_\_\_\_\_ hangers that provide correct support without causing damage for wardrobe

## **II. Write Short answers**

1. Define family budget
2. List out the categories that come under family expense
3. What are the advantages of seasonal clearance?
4. What is meant by wardrobe?
5. Define fashion
6. Write about shopping

## **III. Give brief answers**

1. What are budget and its benefits?
2. Write about clothing budget tips and warning
3. Write briefly about clothing expenditure for the family
4. What are the divisions of clothing budget?
5. Explain briefly about the wardrobe planning

## **IV. Give detailed answers**

1. Write in detail about the budget planning
2. Give an account of wardrobe planning

## **Answers**

### **I. Fill in the Blanks**

1. Expenses    2. personal finances    3. monthly expenditures    4. saving money
5. Budgeting    6. Creative thinking    7. wraps and dresses    8. storing clothes
9. Underwear    10. wooden and specialty

## 4. SELECTION OF CLOTHING

### INTRODUCTION

“Clothes make the man” is an old saying, which we accept as a without giving it much thought. Clothes not only “make the man”, but also affect the facial features and the body. Clothing takes the form of symbols used by individuals as a tool for social interaction. This forms non-verbal communication. Climate has obviously played an important role in determining the necessity for inventing the various kinds of clothing worn by humanity. The temperate zones are responsible for clothing which covers substantially the entire body. Clothing protects the wearer against, heat, cold and sand storms.

#### 4.1. CLOTHING IS CLASSIFIED INTO TWO CLASSES:

- The fixed
- The modish

The fixed are substantially permanent and are not subject to fashion changes but vary with each locality. The modish type predominates in the western countries and changes rapidly in point of time over all parts of the world, which are subject to fashion changes.

#### 4.2. FUNCTIONS OF CLOTHING

- Clothing is useful in protecting the body and providing comfort.
- Clothing itself is self-expression.
- Clothing indicates prestige.
- Clothing is ornamental or possesses aesthetic qualities.
- Clothing has qualities, which tend to attract the opposite sex.

#### 4.3 THEORIES OF CLOTHING

Four theories have been developed and they provide some “food for thought” and the opportunity to think critically about clothing.

- **Modesty Theory** : It suggests that people first wore clothing to cover or conceal the ‘private’ parts of the human body. The modesty theory is based on the idea that morality is dependent upon modesty, as expressed through the concealment of the human body.
- **Immodesty Theory** : Immodesty theory or sexual attraction explain that individuals may have first worn clothing in order to attract attention to, rather than to conceal, the sexual organs.
- **Adornment Theory** : This theory refers to the decorative nature of clothes and other forms of appearances; modifications for purposes of display, attraction or aesthetic expression.
- **Projection Theory** : This theory suggests that clothes protect humans from the elements, animals or even supernatural forces.

#### 4.4 SELECTION OF FABRICS FOR CLOTHING

Right clothes are necessary for health, poise and self-respect. An individual who lives within a planned budget is usually happier, more contented, than one who spends the money as one earns it. It

is true, our desire or wants are unlimited. Our needs are comparatively few. While adjustment for needs are essential and important in family life, catering to mere wants is undesirable for development of personality. There is a difference between “wants” and “needs”. A good clothing plan may include both.

### **Practical tips for choosing the fabrics**

- One of the first things is to find out one’s needs and to make a plan for spending one’s cloth needs. Let the plan be in relation to the family budget. Study each member’s list of clothing needs, and decide to spread purchase of clothing for all, throughout the year.
- The next step is to put the plan into action. Consider the purpose for which the fabric is to be used – for instance whether for “work-a-day” wear or for a special occasion. Buy only the clothing item decided for purchase. Avoid buying on impulse,
- Choose and buy good quality; cheap things are rarely an economy.
- Compare prices and values at different stores.
- Try to keep up to date on trends.
- Discover ways and means of renovating old garments and develop skills in stitching simple cholis, dresses and other garments at home.
- Remember taste is the ability to discern or appreciate what is beautiful or appropriate.

### **4.5 FACTORS AFFECTING SELECTION OF CLOTHING**

The selection of clothing should be done on the basis of age, season, income, occasion and fashion.

• **Age :** While selecting fabric one has to think of the age group of the child. For small children, dainty prints in soft colours can be chosen. Nursery prints are not suitable for elementary school children. When the children enter late childhood stage, the boys like masculine colours, for examples blue, grayish blue, and brown and girls like to wear feminine colours like pink, green and red. Some fabrics, which are delicate, are chosen for girls clothing whereas, rough textured fabrics are suitable for adolescent boys.

The style of the dress also changes according to the age group of the child. The A-line dresses are suitable for toddlers and infants. Later on, dresses with lots of gathers are suitable for girls’ frocks. In the same way type of collars are suitable for younger age group, for example baby collar is not suitable for adolescent.

• **Season :** Some fabrics and colours are suitable for winter while others are not, for example synthetics; silk and wool are suitable for winter as they are bad conductor of heat. Cotton and blends of cotton with synthetics are good for summer as they are good conductor of heat and absorptive. There are cool and warm colours. The cool colours are associated with coolness, for example, blue, green, white etc. Warm colours are bad conductors of heat and associated with warmth for example, red, golden yellow and orange. So warm colours are suitable for winter, whereas cool colours are chosen for summer.

• **Income :** Amount of money affects the selection of clothing. Children belonging to high-income group can spend more percentage of money on clothing as compared to low income. They can spend more money on fashionable garments rather than on durable clothes. Parents belonging to low-income group prefer durable clothes rather than delicate ones. So the preference of the clothing changes according to

the income of the family. Low socio economic growth gives more importance to durability, comfort and price as compared to becomingness and beauty.

- **Occasion :** Selection of clothes also changes according to occasion. For daily wear or informal wear, durable dresses with simple designs can be chosen but for occasional or formal wear novel fabrics with new styles are chosen.
- **Fashion :** Fashionable clothes look beautiful. One looks odd when one go out of fashion. Few fabrics and colours are in fashion while others are not. Some clothes should be brought according to fashion and others should be simple. Children belonging to high-income group can wear fashionable clothes to great extent as compared to low-income group. Too much of fashion should be avoided.

#### **4.6 CLOTHING SELECTION FOR THE FAMILY**

Clothing selection for the family presents a greater challenge today than in past generations. Custom and habits are no longer adequate criteria for clothing decisions. The kind and variety of clothes available today seem almost limitless, as a result of the new technology and its accompanying mass production of garments. The inventions of the man-made fibers have been one of the most important stimulants in the recent revolution in clothing and textiles. These fibers have increased greatly the variety and types of clothing available to families. The rising income over the last quarter century has made it possible for families of all income levels in the country to exercise choice in the area of clothing. All these factors have influenced the range and emphasized the importance of decision to be made by families in providing clothing for their members.

##### **4.6.1. Clothing for marriage and the first year**

The following suggestion will help the prospective bride or bridegroom to select clothing that meets all the qualifications,

- Choose the garments and accessories that reflect the personality. Bold designs, strong colour contrasts, rich fabrics are suitable for individuals with forceful personalities, whereas small details, delicate fabrics, and dainty colours are best for those with gentle personalities.
- Select clothing that is flattering to the figure. Figure irregularities must also be considered.
- The colours selected should enhance the colour of the skin.
- Coordinate colours to make each individual outfit pleasing as well as to integrate the whole wardrobe.
- Should choose only those designs and fabrics that represent moderation in current fashion.
- Keep in mind the different occasions for which an article of clothing will be needed.
- The clothes planned for the wedding should constitute the basic wardrobe for bride and bridegroom for the following year or more.
- The new clothes purchased must be selected to supplement the articles in the present wardrobes of the bride and groom so that a complete, well-balanced wardrobe will be on hand after the marriage ceremony.
- The average young couple begins their married life in an apartment where storage space is at a premium, so that the wardrobe must be planned with this in view.

- Any clothing that requires a great deal of time and money for maintenance will be unsuitable if the bride expects to work after the marriage, if laundry facilities are limited, or if there will be limited funds for clothing maintenance.
- Any wedding clothing that will not be worn after the wedding must be stored and cared for or disposed off.

#### **4.6.2 Clothing for Honeymoon**

- The place, season, mode of travel and duration of the honeymoon will determine the type and amount of clothing needed.
- A week end in some large city, a few days in the mountains, a week at the seashore, or a leisurely motor trip of sight seeing is much more common these days than a long cruise, an extended tour, or a trip abroad.
- In planning the honeymoon, a couple should seriously question going to a place that requires special clothing for which they will have no use latter on.
- Clothing for a honeymoon in the mountains or at the seashore is usually casual.
- Semiformal clothes may be needed for afternoon or evening functions

#### **4.6.3 Clothing for Expectant Mother**

- Keeping attractive with smart maternity clothes, careful grooming, and well-chosen make-up helps the expectant mother maintain her morale at a high level.
- The most obvious is the change in silhouette, primarily the breast and abdominal areas.
- Ready-made maternity garments are usually sized so that the pregnant women can continue to wear her customary size.
- Garments made from knit fabrics containing easy-stretch yarns of cotton or nylon are very satisfactory.

#### **4.6.4 Clothing for the Infant (up to 9 months)**

The three “musts” in clothing the newborn baby are warmth, comfort, and hygienic qualities. The amount and type of clothing which the infant will need will be determined to some extent by the time of the year, general climatic conditions, warmth of child’s room and condition of the infant. The most suitable fiber for infant’s clothing is cotton, because it is soft, and can be kept hygienically safe by washing in hot or boiling water.

#### **Key points for selection of infant’s clothing**

- Infant’s clothes should be selected primarily on the basis of comfort and ease of care. Garments which need no ironing, easy to put on the baby, and have no hard or rough surface to cause discomfort are considered most suitable.
- Baby clothes should be soft, pliable and not irritating.
- They should provide ventilation to allow any moisture to evaporate. Inadequate ventilation causes moisture to stay next to baby’s sensitive skin and may result in skin irritations.



- Clothing should be simple and well made. Fancy trimmings require extra care in laundering and often irritate the baby.
- Knit fabric garments stretch with body movements and are easy to put on the infant.
- Openings all the way down the front or back make dressing simpler.
- Ties or flat fasteners are more comfortable; drawstring necklines are not recommended because the infant might become caught in the strings.
- If ties or buttons are used, they should be inspected often to make sure that they are sewed securely.
- The rate of physical growth is very rapid. Extra seam allowances and hems can be given.

#### **4.6.5 Clothing for Creeper (9 months to 1 year)**

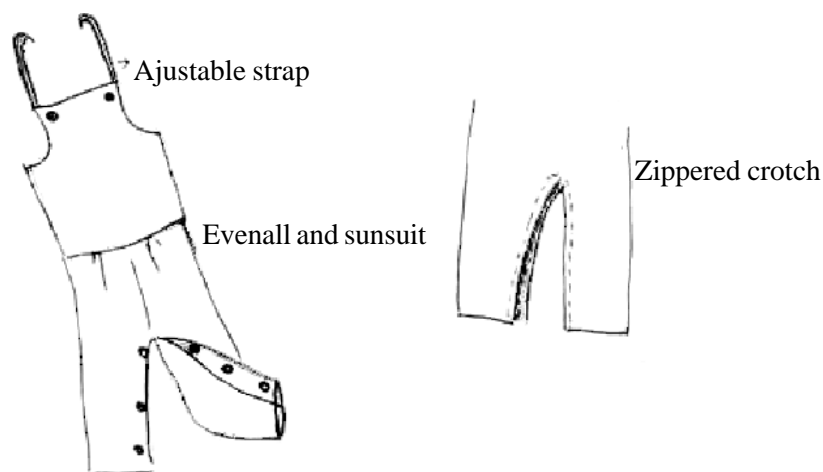
After the baby has began to creep about, more clothes are required, partly for safety's sake. Overalls are the simplest form of garment for both sexes especially those with snaps in the crotch help easy change of diaper. Overalls shield tender knees from floor.

- Reinforcement in the knees of pant legs will provide for greater durability.
- Snapper or grippers on the crotch of overall save time when diaper changes are necessary.
- Garments of firmly woven or knitted fabrics with appropriate seam finishes will give good service for rough wear and many launderings.
- In cold weather zones a snowsuit, mittens, and hood will be necessary. A lightweight wind resistant, and washable fabric such as nylon or polyester is desirable.
- During the creeping ages soft-soled shoes may be worn if protection from cold is needed. Shoes are about ½ inch longer than the toe, and stocking should be ½ inch longer than the foot.
- Training pants are often worn when toilet training begins. (Fig.5, 4). Training pants will continue to be worn until toilet training is accomplished. These pants are made of two-way stretch fabrics, which fit snugly at the hip. Centre panel of two, three, and four layers provide for absorption and protection. Training pants of knit fabrics are desirable, since they will give ease as the child moves about, and the stretch inherent in the fabric will allow for some degree of growth.
- Creepers are physically more active than newborn baby. Their clothes should be able to absorb sweat due to the child's activities. Strong and durable fabrics are suitable for this age group. They crawl on the floor, fabrics from knees wear off due to friction. But strong and durable fabrics can withstand the friction. Reinforcement can be given at knees with the help of a patch.
- Garments with adjustable straps are more suitable due to growing stage.

#### **4.6.6 Clothing for the Toddler (1-2 years)**

- The toddler needs clothing that provides maximum freedom for all the activities usual at this stage.
- Again, overalls are preferred, especially if they have wide shoulder straps that are long enough for adjustments as the child grows.

- Toddlers commonly wear one-piece garments with zipper openings at the legs or crotch. (Fig 4.1)
- One-piece pyjamas are usually safer and neater than two-piece ones. Pyjamas should be made of soft, washable material.



**Fig. 4.1. Overall and sunsuit for toddler**

#### **4.6.7 Clothing for the Preschool child (2-4 years)**

Clothing for the preschool-age child may become a major problem for the family because it is expensive, yet is used for only a short time. It should be selected to help the child develop self-reliance, practice social skills and interact with peers. Garments should be flexible, comfortably warm, easily cleaned, soft, durably encourage self reliance, convenient for frequent toileting, adjustable to the rapidly growing body, and attractive in design and fabric. Children of this age also need make-believe clothing to accommodate their dream world fantasies.

##### **4.6.7.1 Allowance for growth**

- Growth is most rapid during the preschool years.
- Buying clothes with growth features will enable a garment to be worn over a longer period of time.

##### **To provide for growth in height**

- Skirts and dresses with deep hems or tucks at the bottom need to be provided.
- Dresses and trousers with tucks at the waistline to lengthen the upper part of dress or to lengthen the crotch.
- Overalls with adjustable long straps and deep hems are included.
- Yokes with crosswise tucks that can be released as trunk or body lengthens.
- Dresses with indefinite waistline or no waistline and deep hems to be added.
- Stretch fabrics and,
- Two-piece garments are suitable cloth for pre-school.

### To provide for growth in girth or width

- Use raglan or kimono sleeves rather than set in sleeves.
- Introduce tucks, pleats or gathers at the shoulder line.
- Use of large underarm or leg seams to let out as needed.

Garments should be reinforced at places of greatest wear, especially the knees of pants and overalls, crotch and underarm seams.

### 4.6.7.2. Self help features

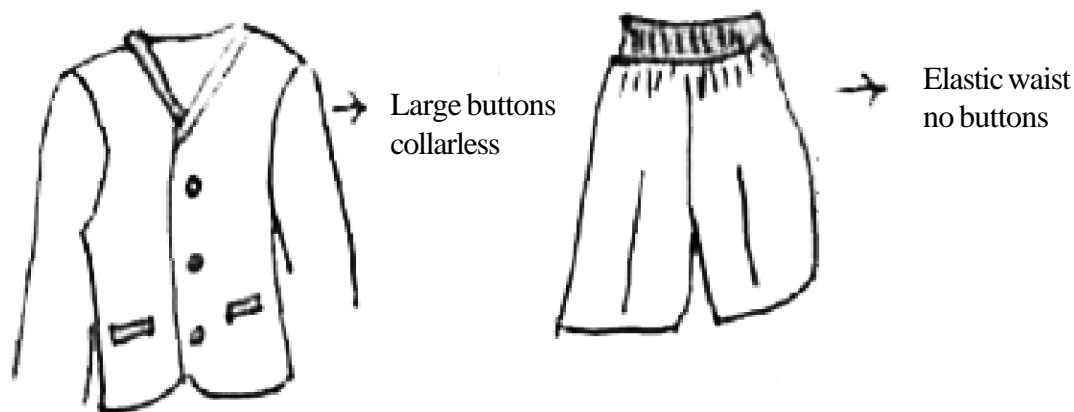
A self-help garment is one, which the child can put on and take off with little or no help from an adult. This feature is as important to child as to his mother. The experience of learning to dress himself makes the child more independent and self-confident. Here are some points to remember in selecting garments that will encourage independence in dressing. (Fig 4.2) & (Fig 4.3)

#### Self help garments for the preschool girl



Fig. 4.2.

- Simple styles are easier to manipulate than complicated ones.
- Long openings are located for easy reach. Front openings are easier to handle than back or side openings.
- Large buttons or fasteners are easier to manage than small ones.
- Ample armholes, sleeves and necks make garments easier to get into. .
- The back of a garment should be easily distinguishable from the front. In pants, it is wise to sew a colored thread either at the front or back of the waist to help the child distinguish one from the other.
- The side of the shoes that goes to the outside should be marked, to help the small child to identify the right from left.
- Collarless dresses, blouses, and shirts are easier to handle than those with collars.
- Avoid separate belts, as these get twisted and caught in the dressing.



**Fig. 4.3. Self Help Garments for the preschool boy**

#### **4.6.8 Clothing for School Going Children (5 to 11 years)**

Clothing needs for elementary school children vary in some respects from those of the preschools, although many requirements remain the same. This period is a very active one physically; sports rate high in interest for both boys and girls. Clothing plays an important role in social development, as definite ideas about clothing likes and dislikes are developing. This is an age of belonging to a group and what the group wears is very important.

Children want to gain acceptance from their peers, to confirm to the gang or group is their way of belonging. They become self-conscious if they dress up in a different manner. Feeling of inferiority may result if they wear an odd look garment.

#### **4.6.9 Clothing for Pre-adolescents (12 years 15 years)**

There is rapid acceleration in growth, as the body is changing and taking on adult characteristics. They are interested in clothes and grooming up. The peer group becomes even more important than elementary school years, in conforming to the dress of the peer group. The pre-adolescent is much more interested in his relationship with others. The child is extremely sensitive to opinion and approvals of others. They give more importance to becomingness, Prince, beauty and conformity as compared to durability and comfort. The order of importance of various aspects vary with the income groups for example, low socio-economic group give more importance to durability, comfort and price as compared to high income group.

#### **4.6.10 Clothing for Adolescents (15 to 20 years)**

For girls the great acceleration in growth has passed its peak by middle adolescence, although some boys may still be growing rapidly. They are developing emotionally, mentally and socially, but are still far from the poised and popular adult. Both sexes seek increased approval from the peers. Adolescents become more conscious of grooming and personal appearance, particularly in terms of what will attract more attention from and admired by others. They want well-fitted, fashionable and expensive garments. Comfort and serviceability are sacrificed for the sake of style and fashion. They seek acceptance and approval of the peer group. This tends to develop within them a deep conservatism and tendency to conform. They embrace clothing as means of demonstrating their conformity. They are greatly interested in clothing and concerned with their physical appearance. Clothing becomes a means of expressing personality.

#### **4.6.11 Clothing for Adult**

A person becomes an adult between 18-21 years of age. A person is mature enough to select the clothes on the basis of income, status, occupation, climate, age, sex, occasion and fashion. A well-dressed person not only appears capable to others but also feels more confident and capable himself. A man's wardrobe is different from a woman. Man's wardrobe includes clothes for business, sports and formal wear. Complete wardrobe for a man includes shirts, trousers, shorts, socks, ties, shoes, nightwear and suit. To an extent of a woman's wardrobe depends on her husband's income, her social activities and her profession. Working woman needs more clothes as compared to a housewife. Those who are socially active also require more clothes than a housewife.

#### **4.6.12 Clothing for Elderly**

Aesthetically, clothing can serve three functions for the older person,

- Call attention to one's good features
- Camouflage poor features
- Give a psychologist lift

Older women may have a sagged bust line, increased waist and hip measurements, and rounded shoulders. Therefore, camouflage is necessary; less extreme lines and styles and looser dresses are generally pleasing. Due to change in colour of hair and skin, different colours may now be flattering. Designs, which emphasize the waist, are generally not becoming.

#### **For Women**

- Knowing the body shape is essential for dressing appropriately for the age. Get in front of a full-length mirror and try on all the clothes in the closet. Get rid of anything that is too tight and too revealing.
- Stick with the classic looks. A well-tailored salwar kameez of different styles or blouse with sari always has been in vogue in India.
- Follow trends in small doses, do it with accessories such as jewellery and scarves. Wearing a few accessories show that one is still fashion forward but not a slave to clothing trends.

#### **For Men**

- Choose clothing that fits the body. Buy button-down shirts that fit both the neck and arm measurements, get the pants tailored and don't wear anything that is too tight or too loose.
- Avoid double-breasted suits.
- Wear appropriate casual clothing. Choose jeans and khakis with straight-cut leg and collared cotton polo shirts.

### **CONCLUSION**

Dressing sense is said to be the reflection of a person's personality as well as it reflects the occasion for which the individual person attends. Depending upon this people are of different tastes, cultures and behavioral of works. Dresses or cloths are divided into casuals wear, formal wear, comfort wear and

traditional wear. Moreover, clothing has been regarded as one of the best ways to distinguish social classes, sexes, occupation, marital status and ethnic or religious affiliation.

To conclude, the clothing for children and adolescents should be selected with as much care as that for the adult. Good garments are of the size and design that makes for comfort in wearing, ease of movement and care.

## QUESTIONS

### I. Fill in the blanks

1. Clothes make the \_\_\_\_\_
2. Clothing is classified into two classes namely the fixed and the \_\_\_\_\_
3. Right clothes are necessary for health, noise and \_\_\_\_\_
4. Children belonging to high income group can spend more percentage of money in clothing than \_\_\_\_\_
5. Low socio-economic growth gives more importance to durability, comfort and \_\_\_\_\_ as compared to becomingness and beauty.
6. Too much of fashion should be \_\_\_\_\_
7. Clothing selection for the family presents a \_\_\_\_\_ today than in past generation.
8. Select clothing that is flattening to the \_\_\_\_\_
9. Colours selected should enhance the colour of the \_\_\_\_\_
10. The three “musts” in clothing for new born baby, are warmth, comfort and \_\_\_\_\_
11. Snapper or zipper on the crotch of overall saves time when \_\_\_\_\_ changes are necessary.
12. The toddler needs clothes that provides maximum freedom for all the \_\_\_\_\_
13. Growth is most rapid during the \_\_\_\_\_ years.
14. Front opening are easier to handle than \_\_\_\_\_ or \_\_\_\_\_ openings.
15. Feeling of inferiority may result if children wear an \_\_\_\_\_ look garment.

### II. Write short answers

1. How is clothes classified?
2. State the functions of clothing.
3. Explain the theories of clothing.
4. Briefly explain the clothing for the toddler
5. Explain the points to be kept in mind while selecting clothing for an expectant mother
6. Write notes on self-help features in a dress.

7. Explain the point “allowance for growth” in clothing for pre-school child.
8. Briefly explain the clothing for school going children.
9. Write notes on clothing for pre-adolescent
10. Bring out importance of clothing for adolescents
11. Write notes on clothing for adults

**III. Give brief answers**

1. Write in detail the practical tips used for choosing the fabrics.
2. List and explain the points to be looked for while selecting clothes for creeper.
3. List the key points for selection of infants clothing
4. Explain the clothing suitable for the preschool child.
5. How is clothing selected for the periods of marriage?

**IV. Give detailed answers**

1. Give an account of the factors affecting the selection of clothing
2. Explain in detail the points to be considered while selecting clothing for elderly.
3. Give an account of the various points to be considered in selecting clothes for children at various stages.

**Answers**

**I. Fill in the blanks**

- |            |                |                 |                  |                        |
|------------|----------------|-----------------|------------------|------------------------|
| 1. Man     | 2. Modish      | 3. Self-respect | 4. Low-income    | 5. Price               |
| 6. Avoided | 7. Challenge   | 8. Figure       | 9. Skin          | 10. Hygienic qualities |
| 11. Diaper | 12. Activities | 13. Pre-school  | 14. Back or Side | 15. Odd                |

# 5. DESIGNING IN CLOTHING

## INTRODUCTION

For successfully designing a garment or decorating, it is necessary to understand what constitutes a good design. The entire purpose of spending the scarce resources like time, effort and money on designing and decorating a garment is to make it attractive and pleasing to the eye.

A design can be defined as an arrangement of lines, shape, colours and texture, that create a visual image. Designing means moving from the state of randomness to the higher state of organization, to create a design or impression or to communicate an important / innovative idea. On the highest level of design is the careful and knowledgeable manipulation of art elements to produce an expressive personal idea.

There are two basic divisions of designing in the field of clothing. There are two divisions which are often inseparable, which can be defined in other words as factors influencing the design.

5.1. Structural designing

5.2. Decorative designing

### 5.1. Structural Design

Includes the all over design of a garment its form and shape plus all the details involved in assembling the sections of the garment such as darts, pleats, tucks etc. Structural design may add a decorative quality if emphasized by colour contrast or row of top stitching to outline the basic garment parts. In apparel, structural design is more important because it is the fundamental component of design.

### 5.2. Decorative design

These designs need the basic form and the designs drawn will be draped over it. It will have more trimmings, prints, embroidery, buttons and tacked on bows. In these designs the fabric, style and colour combinations are described so that one can select the design.

To enhance the beauty and personality of the person, elements of design and its principles should be used appropriately.

### 5.3. Elements of Design

A complete knowledge on the various fundamental elements of art and design would help a person to create and design a garment on an aesthetic manner. To create beautiful garments consistently one needs to follow certain guidelines in selecting and arranging design elements. In creating a design one of the components which interact is the Design Elements.

The elements and principles of design are flexible and should be interpreted within the context of current fashion. The principles of design are the rules that govern how elements are combined. The elements are therefore the raw materials that must be combined successfully.

The following are the different elements of Art.

5.3.1. Line

5.3.2. Form and Shape

5.3.3. Colour and

5.3.4. Texture

These elements are considered as 'plastics' in art language because they can be manipulated or arranged by the designer to create a desired illusion.



**5.3.1. Line:** Line has different aspects including direction, thickness, sharpness of edge and length. It provides the visual dimensions of length and width. When lines combine, space is enclosed, forms and shapes are defined. Lines offered a path of vision for the eyes when wearing an outfit. Line has several functions,

- To create a mood.
- To define and create shape.
- To indicate direction.
- To lead the eye.
- To establish a point of emphasis.
- To create an illusion
- To indicate dimension of length and width.
- To enclose space.

**a) Types of lines:** There are only two kinds of lines - straight lines and curved lines. Straight lines can take four directions. Vertical, horizontal, diagonal or zig zag. A curved line may be extreme, approaching a full circle or it may be very gentle or subtle almost straight.

**(i) Straight lines:** Straight lines are in opposition to the natural curve of the body. They are rigid or crisp. The use of straight lines in clothing design is very often softened by the texture of the fabrics selected. For eg. When a soft fabric such as Jersey is used, the straight lines drape on the body curves, stiff fabric such as organdy or taffeta maintain the straight line because they stand away from the body.

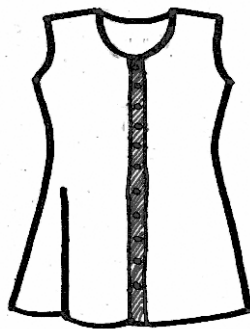
Lines within a garment are created by darts, seams and decorative details. Each kind of line produces its own special effect. Straight lines and shapes denote force and strength and have a masculine quality, curved lines are the lines of nature, they are graceful and gives a feminine effect. Lines are the greatest devices of fashion designers. Since lines create illusion of height and width, they can be used to one's requirement to tone down a particular figure type.

Each direction of a straight line (vertical, horizontal, diagonal, zig zag, creates an optical effect or illusion that must be judged on the individual to identify the effect in a particular garment design.

The arrangement of lines in clothing design can cause to appear taller, shorter, heavier or thinner than what actually is and how line is used creates a mood in a garment. Line and the optical effect that they create, can make hips look small or large, shoulders look broad or narrow, and waists look thick or thin. The effects that lines produce are related to other factors such as,

- The shape of the body wearing the design.
- The colour of the fabric.
- The degree of contrast that enable the lines to be noticed.
- The comparison of adjacent shapes or spaces formed by lines.
- The fabric drape, hand, weave, print and texture.
- The effect that the viewer has been pre conditioned to expect.

**(ii) Vertical lines:** These produce an illusion of added height to the outfit design by adding and contrasting coloured vertical band in the centre or a center panel shown in Fig. (a) added with vertical line gives an added height to the outfit. These lines tend to make a short person looks tall. Eg. Fig (b) princess style dress also has the same effect. When a vertical line is emphasized in garment design, the eye of the observer measures the length of that area. Noticeable vertical lines that divide skirt / pant and bodice / skirt areas can reduce the apparent visual width of these spaces. To illustrate a plain skirt, undivided by visible seaming, usually appears broader than a skirt with one or more vertical seams in the front and back sections. the angle and spacing of two or more visible vertical seams in the same garment will vary the effect of slimness and length.



(a)



(b)

**(iii). Horizontal lines:** These lines add width to the garment and decrease the apparent height, for eg. A wide contrast coloured belt shortens the height of the figure by cutting the garment into two segments, however the belt has the effect of slimming the waist line, the self coloured will not shorten the height of the outfit as well as the wearer. Fig (c) shows a deisgn with horizontal lines dominating.



(c)

**(iv) Diagonal lines:** These lines add or decrease the height of the wearer depending on their slope. Long uninterrupted diagonals view almost vertically are the most lengthening and most dramatic of all lines Fig (d). Diagonal lines should be combined with vertical or horizontal lines. If they are used alone for the entire dress the effect will be disturbing.

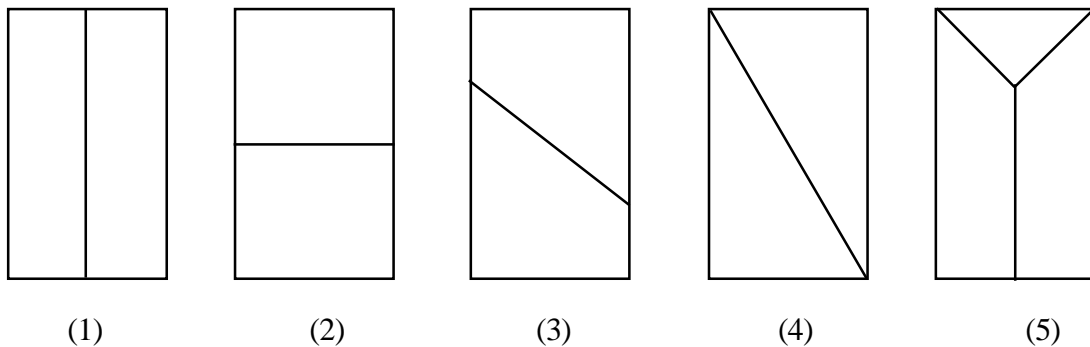


**(v) Curved lines:** These lines are more romantic by nature and are considered graceful and feminine, those in a diagonal direction are the most graceful and can be seen in the soft folds of material in a draped dress or a ruffled collar. Curved lines generally follow the contour of the body. When the curved line becomes exaggerated towards a full circle, it becomes very active and may easily be overdone. A restrained curve is graceful, flowing and gentle. Just as straight lines can conform to the body contour through fabric textures so do curved lines – with the effect of being extremely curvy. For eg: If a ruffle is added to a garment, the eye moves quickly over the smooth parts of the garment and tends to rest on the ruffle. Placing a ruffle at the wrist, therefore will attract attention there. Adding fullness to any part of a garment attracts attention. Curved lines can add weight to a thin person or even an angular person.

**(vi) Zigzag lines:** A zigzag is a series of connected diagonal lines. A zigzag forces the eye to shift direction abruptly and repeatedly in an erratic and jerky movement. This type of line is found most often

in fabric design. Because of the eye activity caused by zigzag lines, they tend to increase the apparent mass or size of the area covered by them.

**A Visual summary of the illusions created by straight line combinations is found in Fig (1 - 5).**



**Fig. 1:** Vertical line appears to lengthen, appears slimming as the eye moves up and down.

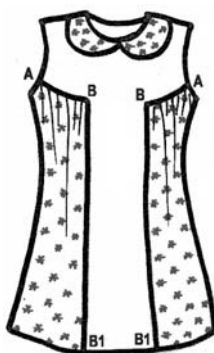
**Fig. 2:** Horizontal line appears to shorten, appears to widen as the eye travels across.

**Fig. 3:** Diagonal line appears to shorten and widen as the slant is closer to a horizontal.

**Fig. 4:** Diagonal line appears to lengthen as the slant is closer to a vertical.

**Fig. 5:** Extended diagonal lines appears to lengthen as the eye continues to move upward.

**b) Line movements:** The arrangements of vertical, horizontal and oblique lines produce line movements characterized by opposition, transition or radiations opposition; In a design where the vertical line is opposed by a horizontal lines opposing oblique lines are used. Fig (e) shows a design in which the vertical line BBI is opposed by the horizontal line AB. In the design shown in Fig (f) opposing oblique lines are used.



(e)



(f)

**(i) Transition:** When one line direction slips smoothly into another, the movement is transitional . eg. Curved lines. Curved lines should not be over done. They are at their best when stiffened by same straight lines, eg: round yoke with vertical pin tucks within it as shown in Fig. (g)

**(ii) Radiation:** Fig. (h) shows a design is created with radiating lines at the neckline, it will attract attention to the face. These radiating lines are produced by stitching decorative darts on the right side of the garment.



(g)



(h)

### c. Interrelationship of Elements of Design.

Understanding the role of space, shape, and form and developing the skill to analyse line direction helps one learn to predict the effect of each design. Because these design elements combine with color and texture to produce all designs, they are important in all areas of creativity.

When applied to clothing selection, the importance of space, shape, form and line becomes obvious. The three-dimensional form of the body within the garment creates contour, which gives the garment shape, but the illusion of the shape of the garment is always dependent upon the form of the body within the garment. The space of the garment is the background area found within the shape or silhouette. The division of this space with construction details, decoration, texture, color and printed fabric design is critical to the style of the garment. Lines are used to create the form and the shape of the garment and to divide the space within the shape of the garment lines lead the eye in a definite direction. The elements are all responsible for determining how the garment looks on the body.

#### 5.3.2. Form and Shape

**Form:** It is an object having three dimensions like length, width and depth. The human form changes visually with clothing, especially as fashion changes.

**Shape:** It describes the outer dimensions of an object. Through clothing design, the shape of the human body is often revealed in a natural way, but sometimes even distorted. The shape of clothing on a human body, communicates silently, the messages about the wearer.

The shape of the body plus the lines of garment create an overall form that defines the garment silhouette. Often the silhouette gives the first impression because it is seen from a distance and because it is contrasted to a background. The silhouetted form of the clothes next to body reveals the shapes of various parts of the body line, and the garment, such as sleeves, shirt or pants.

Every fashion period, a shape emerges slowly or evolved suddenly, whatever it is, every period has a specific shape of garment which once determined can be modified and be styled for variation in design without changing the basic shape of the garment, it is either flare or tight, circular or straight, a line or raglan. It is therefore advisable that the designer chooses an easy silhouette to keep on creating for a longer duration.

Shape and form are the terms that are used inter-changeably with some differences. The term 'form' is generally considered to apply to two-dimensional areas or shapes as well as to three-dimensional volumes or masses as "shape". When lines are joined to enclose space, they result in an outline, a contour, or shape. When a two-dimensional shape acquires a third dimension, it becomes a form. The

form of an object usually suggests its use. Form may be viewed as an enclosure of volume surrounded by limiting factors. Shape is the primary means by which we distinguish one form from another. It may refer to the contour of a line, the outline of a plane, or the boundary of a mass. In each case, shape is defined by the specific configuration of the lines or planes which separate a form from the background or surrounding space.

Form is an important element in decoration. Without beauty of form, application of excellent colour, texture and decoration are of no use. It can be said that two essentials of good form of an object are that it,

- Should suit its function
- Should be strongly influenced by the material with which it is made.

There are three broad categories of shapes and forms. Natural Shapes represent the images and forms of our natural world. These shapes may be abstracted, usually through a process of simplification, and still retain the essential characteristics of their natural sources. The second type of shape and form is abstract. This type of shape and form is derived from objects in nature or from other things that are familiar to us; however, they have been distorted, exaggerated, and reorganized, and at times beyond recognition. The third type of shape and form is called non-objective. Non-objective shapes make no obvious reference to a specific object or to a particular subject matter. In this grouping, geometric forms and biographic shapes are found. Some non-objective shape may result from a process such as calligraphy and carry meaning as symbols. Others may be geometric and elicit responses based on this purely visual qualities.

**a) There are three separate and distinct types of geometric shapes.**

- Rectilinear – Square or rectangle
- Angular – Triangle or pyramid
- Curvilinear – Circle, sphere, cone, cylinder

In their most regular form, curvilinear shapes are circular while rectilinear shapes include the series of polygons which can be inscribed within a circle. In all these, the most significant geometric shapes include the circle, triangle, and square. Extended into the third dimension, these primary shapes generate the sphere, cylinder, cone, pyramid and the cube.

**(i) Squares and rectangles :** The square form represents the pure and the rational. The equality of its four sides and its four right angles contributes to its regularity and visual clarity. A square shape has no preferred or dominant direction. It is a stable, tranquil figure when resting on one of its sides, but becomes dynamic when standing on one of its corners. The square form epitomizes strength but, used exclusively, it tends to become tedious (hence the descriptive term ‘square’ for certain people).

All rectangles can be considered to be variations of the square with the addition of width or length. While the clarity and stability of rectangular shapes can lead to visual monotony, variety can be introduced by varying their size, proportion, colour, texture, placement or orientation.

**(ii) Triangles :** Triangles contribute unity and balance. The triangle represents stability. The dynamic quality of a triangular shape is also due to the angular relationships of its three sides. Because these angles can vary, triangles are more flexible than squares and rectangles. In addition, triangles can be

conveniently combined to form any number of square, rectangular and other polygonal shapes. Pyramid and triangles differ from rectangles and squares in their pointed dynamic character and express greater flexibility.

**(iii) Circles:** The circular forms are also useful and compact. It represents unity, continuity and economy of form. They are man's and nature's most conservative and economical forms as they enclose the greatest area and volume with least surfacing. A circular shape is normally stable and self-centering in its environment. When associated with other lines and shapes, however, a circle can appear to have an apparent motion.

**b) Pattern :** Pattern refers to any sort of extrinsic surface enrichment. It is a two-dimensional or three-dimensional ornament arranged in a motif form. Because patterns can be created by textures and forms and is found in the shape of individual items. Pattern has movement and should be arranged so that it will flow with the rhythm of the object it adorns.

Pattern can coordinate the entire decorating theme.

The cost of an dress is no indication of the quality of the decorative pattern used on it. The finest designers are employed chiefly for expensive goods. However, we also find that their designs are adapted or duplicated or imitated in inexpensive materials. It is desirable to buy patterned articles and other furnishings and fabrics designed by famous designers. Manufacturers often underestimate the taste of the consumers and make articles decorated with cheap elaborate designs, which people buy because nothing else is available.

Pattern creates an illusion of depth and adds character and to garment. A pattern is an overall design. A 'motif' is an individual unit of pattern. Fabric design is often created when motifs are repeated in a manner to create an overall pattern. These may be considered formal – showing a regular or methodical repetition of the motif, or informal – having irregular placement of motifs.

While choosing a patterned fabric, design of the fabric and colour are enormously important. Patterns range from huge flowers in rich blue and pink plus purples, mauves and apricots to paisley patterns in dark blue, deep magenta and burnt orange and colourful spots and stripes. While buying a fabric that is to be pleated / gathered as draperies / curtains, check how the pattern will look pulled together in their way. Some subtle designs come to life when used in a pleated or gathered form, while other patterns lose their impact.

Space is generally considered to be the area seen between the shapes. But space in clothing becomes distractive and fatiguing to view where an interesting space may go unnoticed or appear monotonous. Both repetition and extreme contrast of a line, shape, space or form produce emphasis.

**5.3.3. Colour:** Colour is an important art element which no one can ignore. Appreciation of colour is largely an emotional process, is felt by nearly everyone, where as appreciation of other art elements such as line, form, texture etc, a large intellectual process is not so common. Colour is a source of universal pleasure and is used by everyone to delight them and also to fortify their living environment by its stimulating effect.

Since the world is filled with colours ranging from dull, grayish tones to more vivid, brilliant hues, its seems difficult for us to learn to recognize the names accurately and identify colours accurately. The dimensions of colour are hue, value and intensity. By using these terms the dimensions of colour can be

more effectively communicated. Hue is the name of a colour family such as red, blue or green. The term hue is often enormously used interchangeably with the word colour. While choosing a colour one must be at most careful as colour creates the first impression and hence can glorify or destroy once appearance. Even a simple silhouette may be enhanced by using effective colour schemes. As texture is the feel, drape and degree of stiffness and softness of the fabric, it also creates a visual effect upon the wearer, given a small swatch of fabric, the designer can visualize the texture and the feel of the fabric which helps him to design further.

**(i) Warm and cool hues:** Hue may be described as warm or cool. warm hues are those seen in fire. They are red, yellow and orange, cool hues are those found in water and sky, they are green, blue and violet. The warmth or coolness of a hue carries with it an illusion of visual height. The warm hues yellow, orange and red are known as advancing hues because they create an illusion of moving forward. Warm hues make objects, shapes or areas appear larger, more important and closer than other colors. Warm hues emphasize the body size and contours. cool hues make objects, shapes or areas appear smaller less important and further away than other colors. cool colors minimize body size and shape.

Value describes the lightness or darkness of a color. To change the value of a color white or black must be added, which makes the color lighter or darker.

**(ii) Value related to Body size and form :** Applying value in clothing selection is most important. Exiting and dramatic effects and clever body camouflaging can be crated by the use of value in clothing selection.

The extremes of value, very light or very dark or very low values will out line or silhouette the objects, shapes or areas and make the body contours stand out white is the lightest value, black is the darkest value white and black garments are generally strong contrasts to their back ground, especially during day light hours. Because night lighting is low in value compared to day light, darker – value clothing worn in the evening usually blends in to the background. The effect of the value of the color against a background is important for those who do not wish to reveal their body conformation.

**Chroma or Intensity:** Chroma describe the purity of a color and is expressed as the strength or weakness, the brightness or dullness, or the degree of saturation of a color – chroma and intensity are often interchangeable but, because chroma is the more accurate term, it appears more frequently in color literature. High chroma colors are pure, strong, brilliant saturated colours. Low chroma colors are muted, weak, grayed and dull. Bright, strong, high-chroma colors are conspicuous and make the body appear larger. Dull, weak low-chroma colors are less conspicuous and make the body appear smaller.

**5.3.4. Texture:** Texture is the element of design that describes surface appearance and feel. Textures are compared to other textures with which they are combined and to the person wearing them. Some adjectives used to describe textures are smooth, heavy, thin, crisp, glossy and rough.

An understanding of the dynamics of texture helps individual consumers and fashion professionals make better decisions as they select apparel products and items of personal adornment.

**(i) Texture as a sensory impression :** Textile qualities refer to coarseness, softness or rigidity as recognized by touch. Texture refers to the surface qualities of things. The visual aspect of texture is perceived by the eye because of the degree of light absorption and reflection on the surface of the material.

Texture is fully comprehended by touch, but it is not always necessary to feel an object to understand its textile qualities. Lustrous textures are seen in satins and dull textures in fuzzy wools. Textures has the definite dimensions of weight, size, bulk and shape. These physical dimensions are also visually perceived. Each fabric has textural characteristics that can be described by feeling, seeing or feeling and seeing.

Feel – Soft – Crisp, smooth – rough

See – Shiny – dull, opaque – transparent

Feel and see – thick – thin, clingy – rigid

**(ii) Components that determine texture :** Texture is determined by the arrangement of the component parts in fabric. These are the fiber, the yarn, the fabrication, Eg. Weave or knit and the finish that make up a fabric. Fibers are spun into yarns, which are used to construct fabrics of varying textures. The finish given to fabric after it is constructed can impart texture as well as other qualities. Texture determines how the fabric should be used. Garment designs that do not respect the fabric texture characteristics cannot be satisfactory.

**a) Fashions in Textures:** Fashion as well as silhouettes and colors enter and leave the fashion picture. The style of the garment determines which textures will be used. Changes in fashion bring changes in texture. Tailored garments are cut and sewn for a trim fit. To drape is to arrange in loose folds. Drapable means the ability to hang in following lines or loose folds. Because texture and garment styling must be compatible. The fashion reappearance of textures as well as garment designs occurs periodically.

**b) Selection of Texture:** While selecting textures the individual proportions, skin and hair textures and personality must be considered.

**c) Effect of Texture on physical proportion :** Textures have the physical properties of weight, size, bulk, shape, light absorption and reflection. Textures can produce illusion that change apparent body size, can make one look heavier or thinner.

Fashion professionals and consumers must consider the dynamics of fabric texture, the design of the apparel item or accessory, and the physical, psychological and social characteristics of the individual in choosing fabric textures.

#### **5.4. Principles of Design in Clothing**

The principles of design can help when selecting apparel designs at the point of purchase or during customization of construction. The principles can also be helpful not only when selecting separate garments but also when coordinating several garments and accessories into a complete outfit. The principles of design are useful in creating different forms of expression in our artistic manner, which are pleasing and attractive to the eye. Following are the principles of designing.

5.4.1. Balance

5.4.2. Emphasis

5.4.3. Harmony

5.4.4. Proportion

5.4.5. Rhythm



**5.4.1. Balance:** In clothing, balance refers to a visual attribution of weight, from a central area. Balance refers to the restful effect achieved through grouping design details to maintain a feeling of equal weight or attraction from side to side, front to back or top to bottom. Pleasing balance brings about a satisfying relationship among all design parts to produce visual harmony.

When the design elements of line, form, shape, space, color and texture are in balance, a pleasing harmony is established in clothing designs, three kinds of balance are observed,

- a) Formal balance, also called symmetrical balance or bilateral symmetry.
- b) Informal balance, also called asymmetrical or occult balance.
- c) Radial balance

**a) Formal balance:** Occurs when object appears to equalize each other by repetition and arranged at equi-distance from the centre. The upper and lower portions of the design are so arranged, as to give an effect of balance. Thus there should not be the effect of too much of weight at the bottom or a heavy appearance. Eg. Dark coloured skirt over lighter shade of pant make a short person appear shorter.

Many examples of formal balance may be found in clothing. Formal balanced designs often give an impression of stability due to the equal or balanced placement of the parts that compose the design. In apparel formal balance may emphasize body irregularities.

**b) Informal balance:** Occurs when objects appear to equalize each other but not through repetition and the arrangement is in an haphazard manner. Here design of different sizes and shapes and of different attractions are arranged. The larger and more attractive designs are kept as far away from the centre. If used correctly, informal designs can be effective in being attractive.

Sometimes formal and informal balance are combined in a single garment. This could happen in a dress when the bodice is informal balance and the skirt design is in informal balance. Such an arrangement often lacks harmony and relationship among the various parts. A design with this mix can appear pleasing when there is an interesting transition between the parts that unifies the two opposite effects. Formal balance is the least expensive to produce apparel in mass production. Informally balanced garment is more difficult to produce. For each section of the garment cuts will have to be probably handled differently.

**c) Radial balance:** Occurs when major parts of the design radiate from the central part. Radial balance uses a central point as the focal point. Pleats, seams, gathers, darts or motifs radiate from the focal point creating a sun burst effect.

**5.4.2. Emphasis:** Refers to the dominance of one part with subordination of others. A good design should have a design feature which is the centre of interest, while other features support it. Designers often create emphasis partially through the careful arrangement of line, texture and colour. It could also be called as focal point. Every design needs same note of interest that catches the eye on a specific area of the garment, contrasting colour can be used to emphasize an area.

A black dress with white collar and cuffs will direct the eye to the face and hands. Some methods of lay emphasis can be,

- a) Grouping of design units
- b) Using contrast of hues

- c) By leading lines
- d) A combination of any of the above
- e) Repeating details such as tucks, gathers, buttons etc.
- f) Unusual shapes and textures
- g) Applied design on a contrast background.

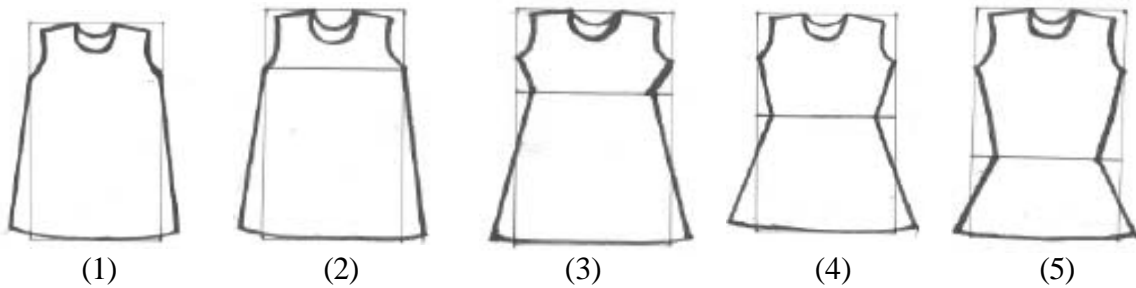
While enhancing the design by concentrating in a focal point the designer must bear in mind the figure and personality of the wearer.

The methods used to obtain emphasis are repetition or concentration. Decoration on a contrast background.

**5.4.3. Harmony:** Refers to unity of design with slight contrast or variety to prevent monotony. If the principle of proportion, balance, rhythm and emphasis are applied creatively, the resultant design is said to have the harmony. First the various parts of the garment (sleeve, skirt, collar etc) should be related to the structure of the style that is every detail should harmonise with each other.

**5.4.4. Proportion or scale:** good proportion refers to pleasing relationship between the sizes of various design details in a dress and between the garment itself and the design details.

Proportion includes the relationship of height, width, depth and the surrounding space of each design. The differences in proportion make designs look different from one another. For example, study the proportions of the five rectangles in Fig. (1-5). In the figure which looks the longest? The broadest? Which division of spaces would gives the most slender illusion for a garment? The tallest? The shortest?



- No. 1 : represents the shape of a garment having no waist line, such as a shift.
- No. 2 : represents an empire line, with the high waist line under the bust.
- No.3 : represents a natural waist line, a classic shirtdress, waist length jacket, and skirt.
- No.4 : represents a waistline dropped to hip level: jacket and part of equal length.
- No.5 : represents a long jacket with a short skirt.  $\frac{3}{4}$  length coat over skirt, long tunic.

**a) Greek law of space division:** A space divided in the proportion of 2:3 is very pleasing to the eye. Eg. In a garment proportion of the bodice length to the skirt length must be 2:3 and the yoke length also bears the same proportion to the bodice length. Pockets on the bodice and the skirt must also have the same proportion.

**b) Scale:** refers to the relationship between the garment and its design details as well as between the wearer and the garment. Eg. Large appliqué motifs attached on a small dress violate the principle of scale.

**5.4.5.Rhythm:** Refers to the smooth movement of the eye from one part of a design to another. Therefore a rhythmic pattern needs to be established to give a costume unity. Rhythm can be obtained through regular repetition of shapes and decorative details like tucks, pleats, scallops, buttons etc. Gradation in size also contribute to rhythm. This type is sometimes referred to as dimensioning rhythm.

Rhythm can be achieved through the combination of lines, shape, colour and texture by the following aspects in designing.

- By regular repeats of trims, texture and fabric design and prints.
- Progression or radiation in sizes of trims, colours, textures and fabric designs.
- Radiation or movement from the central point occurring within structural details such as gathers, folds, tucks, darts etc.
- Continuous flowing lines such as those in bands of colours, textures and fabric designs.

Fabric design with widely placed motifs may lack rhythm. These designs must be evaluated critically before they are cut and constructed into a garment often the garment design will interrupt this type of fabric design and produce strange effects.

Each consumer and fashion professional becomes a designer creating an artistic composition when he or she creates a total look through the selection of garments, accessories, hairstyle, and facial adornment.

## **5.5. Hints on Designing of Dresses**

To be able to combine the basic elements of the design namely colour, line, texture, shape and form so as to produce charming, interesting and graceful effects, one must necessarily have a knowledge of the principles of art or design classified commonly as harmony, proportion, balance, rhythm and emphasis. These principles will help to create designs of good taste (if applied with imagination) and to evaluate designs critically).

How can you develop taste, imagination and ability to create your own designs. First of all you must collect design ideas by going through fashion magazines, books with historic costume plates, books with pictures of national and peasant costumes, tribal costumes etc., you can also observe costumes displayed in museums, dresses of people in famous portraits and current styles displayed at readymade and worn by well dressed people whom you see at movies, parties, shops, functions etc. Close observation trains the eye to distinguish distinctive designs from commonplace designs and good designs from bad ones.

Secondly you must learn to sketch designs. to start with, using a tracing paper you can trace carefully and exactly few designs from current fashion magazines or pattern books. Later practice free hand drawing first by looking and copying the designs on hand and next by observing each design carefully and then sketching it from memory. After you have trained yourself to do this, you will be able to put down on paper designs of dresses you may have observed while doing window shopping when attending social functions.

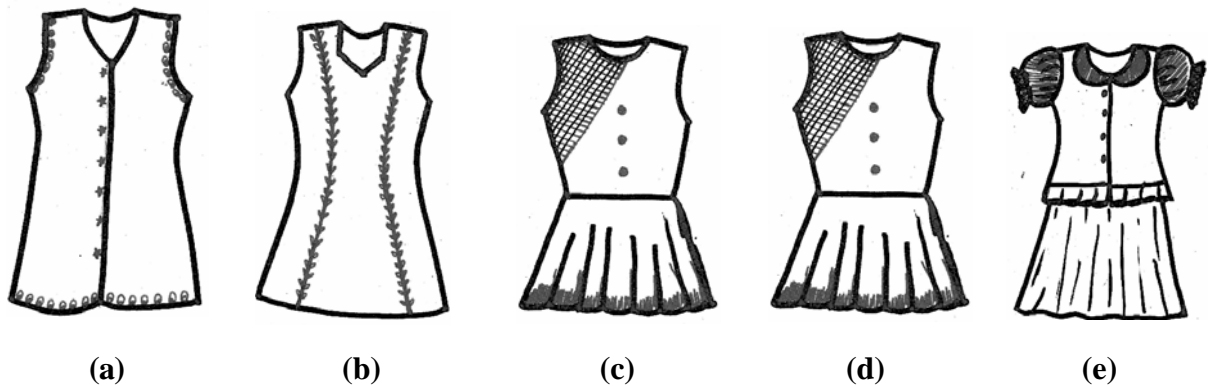
Next develop the ability to evaluate or judge designs by critically analysing their design details, decorative details and style lines in relation to the design of the dress and the personality of the wearer keeping in mind the art principles.

Fourthly, train yourself to observe a design and modify it or adapt it to suit current fashions, different types of personalities, different age groups, sex, occasions, and purposes. From one design idea, try to sketch about ten designs with slight variations.

Finally, make an attempt to create your own designs by putting on paper sketches from your imagination which should have been enriched by now by the practice you have been observing and sketching a variety of designs.

**5.5.1. Basic cuts or styles**

Chemise or A line style (Fig. a). This type of dress is cut in one piece without a waistline seam. This style is also referred to as sacque, shift etc. and is suitable for pre school children’s dresses, duster coats, nighties etc. To bring the effect of the waist line, a belt can be used. More fullness can be introduced in to the waist line or skirt area of this style by dart manipulation and slash and spread method. Princess style (Fig. b). This type of dress has no waistline seam but has a vertical seam as shown in the figure. Middy or long torso style (Fig. c). This is a low waisted dress with the skirt attached to the extended waistline. One piece style with waist line seam at the natural waist line (Fig. d). The skirt for this style may be gored, gathered, pleated flared or circular. The bodice section of this style ends at the natural waistline. The two piece dress (Fig. e) eg skirt and blouse. The front of the dress may have a waist line seam but the back may be of the ‘A’ line type.



**5.5.2. Basic silhouettes**

The dictionary meaning of silhouette is a dark image outlined against a lighter background”. The silhouette of a garment design refers to the outline shape that it gives to the wearer. Silhouette is determined by the texture of the fabric and the cut of the garment, the length and width of the garment, position of the waist line, length of the shoulder seam etc. Silhouettes may be classified as tubular, normal, a line, bell, clinging bouffant etc. The basic feature of the tubular silhouette is a narrow skirt (Fig. 1a). A line silhouette is produced by a skirt with a slight flare (Fig. 1b). The bell silhouette is full skirted. Fullness may be in the form of gathers, pleats or flare. Fig. 1c shows a medium bell silhouette and (Fig. 1d) an extreme bell silhouette which is sometimes referred to as bouffant silhouette. Stiff fabrics like organdie and taffeta produce bouffant effect, while clinging fabrics like full voile creates a clinging silhouettes. Thin figures and stout figures should avoid extremely tubular or clinging styles as well as extreme bouffant styles.



(1a)



(1b)



(1c)



(1d)

The design elements just discussed to face shapes, hair styles and neck lines.

**a) Face shapes:** Fashion magazines show a variety of interesting faces, each reflecting its own type of beauty. Fred Feucht design group studied the popularity of various face shapes among consumers and found the most preferred shape for men was the diamond and for women, the heart.

Face shapes are difficult to determine exactly. Reference books often define faces by eight geometric shapes shown below. (Oblong, Oval, Round, Rectangular, Square, Triangular, Diamond, Heart). The shape of the face is examined with particular attention to the division of space, the proportion of the forehead, cheek width and jawline. Also of interest are the lines formed by the facial features. Some people do not have definite face shape but may be a combination of several shapes.



Oblong



Oval



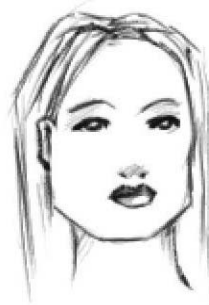
Round



Rectangular



Square



Triangular



Diamond



Heart

**b) Neckline:** Necklines including collars and lapels are face-framing details of clothing. The shape of the neckline is determined by the lines of the garment design. Square faces are emphasized by square necklines, round necklines by round neck lines as well as by square necklines and so on. A triangular face will be complimented by a short V-neckline which will give length to the square jawline.

Neckline can also visually change the neck width and length by using lines to manipulate the neck space. Eg. a long neck can be visually shortened by using a horizontal line high on the neck line to divide the space. A short can be made visually longer by wearing a v-neckline.

The neckline is often the most eye-arresting area of the garment. This effect can be erected by either color or base skin. Bright or contrasting colours used at the neckline area attract attention.

**c) Hair styles:** The lines of a hairstyle can be analysed by considering the head features and body conformation. To minimize a very round face, select a hair style that is neither completely round not straight. To minimize a triangular face, avoid fullness at the widest and narrowest points of the face.

## CONCLUSION

The process of design uses the inter related plastic elements of space, shape, form and line. Line can be either straight or curved. A straight line will have a different effect on the body depending on whether it is vertical (lengthens) horizontal (widens) diagonal (distracts) or zigzag (gives energy). Using curved lines soften that area. An understanding of the impact of these design elements can be applied to clothing selection and personal adornment such as face shapes, hairstyles and necklines.

## QUESTIONS

### I Choose the correct answer

1. The entire purpose of spending the scarce resources like time, effort and money or designing and decorating a garment is to make it \_\_\_\_\_ & \_\_\_\_\_ to the eye.  
a) Attractive & pleasing                      b) attractive & colourful  
c) Gorgeous & Fit                              d) Stylish & pleasing
2. In creating a design one of the components which interact is the \_\_\_\_\_ Elements.  
a) Art                      b) Fit                      c) Design                      d) form
3. \_\_\_\_\_ Offers a path of vision for the eyes when wearing an outfit.  
a) Line                      b) shape                      c) design                      d) colour
4. \_\_\_\_\_ Describes the outer dimensions of an object  
a) Shape                      b) form                      c) line                      d) colour
5. \_\_\_\_\_ is an object having three dimensions like length width and depth.  
a) Shape                      b) colour                      c) line                      d) form
6. \_\_\_\_\_ Contribute unity and balance.  
a) Triangle                      b) circles                      c) squares                      d) rectangle
7. \_\_\_\_\_ Can be created by textures and forms and is found in the shape of individual items.  
a) Pattern                      b) shape                      c) shape & form                      d) line

8. Hue may be described as \_\_\_\_\_ or \_\_\_\_\_  
 a) Warm or cool    b) dark or light    c) dark or appealing    d) dark or cool
9. Texture is determined by the arrangement of the component part in \_\_\_\_\_  
 a) Garment    b) fabric    c) design    d) object
10. The \_\_\_\_\_ is often the most eye-arresting area of the garment  
 a) Neckline    b) colour    c) shape    d) design
11. The art elements are considered as \_\_\_\_\_ in art language.  
 a) Focal point    b) plastics    c) tools    d) signs
12. The \_\_\_\_\_ lines are graceful and gives a feminine effect.  
 a) Vertical    b) horizontal    c) curved    d) diagonal
13. The shape of clothing on a human body communicates silently the messages about the \_\_\_\_\_  
 a) wearer    b) customer    c) designer    d) viewer

**II Answer in one or two sentences.**

1. Define structural design.
2. What is meant by decorative design.
3. List the elements of design and define any one.
4. What are the principles used in designing garments.
5. How are designs classified.
6. List out the principles of design.
7. What are warm and cool hues.
8. State the role of basic divisions of designing in the field of clothing?
9. Mention the types of lines.
10. Enlist the three separate and distinct types of geometric shapes.

**III. Give brief answers**

1. How will you bring Rhythm in frock pattern?
2. How can interest and variety be created in Toddler's dress?
3. What are the components that determine the type of texture.
4. How will you bring harmony and balance in garment construction.
5. Discuss on the design elements to face shapes & hair styles.
6. Describe the basic cuts and styles.

#### **IV. Give detailed answers**

1. Elaborate the role of art principles to achieve pleasing personality.
2. How are art principles applied in designing dresses to minimize figure irregularities.
3. Elaborate on the principles of design in clothing.
4. Colour is a source of universal pleasure and is used by everyone. Discuss.
5. The differences in proportion make designs look different from one another. Explain with illustration.

#### **Answers**

##### **I Choose the correct answer**

1. Attractive & pleasing,
2. design,
3. Line,
4. shape,
5. form,
6. triangle,
7. pattern,
8. warm or cool,
10. neckline



## **6. IDENTIFICATION OF FABRICS AND PRELIMINARY STITCHES IN GARMENT CONSTRUCTION**

### **INTRODUCTION**

In order to understand pattern making and master dress designing one must have a clear knowledge about the fabric. A study about fabric involves various aspects like concepts of grain, right and wrong side and fabric texture.

Great care is required in garment construction. The shape and size of the cut pieces should be maintained to get proper fit, hence it is necessary to join the patterns soon after being cut, rather when they are fresh.

In order to maintain the size and shape, preliminary stitches are given to the patterns. Some of these stitches are stay stitch and basting.

### **6.1. Identification of Fabric by Look and Feel / Touch**

In the modern times, the market is filled with various types of materials, which differ in fiber content, dye, print, surface embellishment, and finish. Each sample cannot be tested in labs to find its servericability and life. Therefore, knowledge about the fabrics by look and feel is essential for everyone dealing with textiles. This knowledge will enhance their ability to select the correct fabric for specific end uses.

#### **6.1.1. Tips to Identify Fabric by Look and Feel / Touch**

- Cotton fabrics are normally stiff. It will get crushed easily and the crease is left on the fabric.
- Silk fabrics are very smooth to touch, bright and lusterious to see. The fingers run softly over silk fabrics.
- Woollen fabrics are course to touch, with small protruding fiber hairs.
- Polyester and rayon fabrics are smooth to touch and lusterous to see. These fabrics do not get crushed easily.
- Twill fabrics show a diagonal effect and are course to feel.
- Napped fabrics (pile and velvet) have loops or short hairy structure. It is smooth to touch.
- Nylon and satin fabrics are very slippery to touch and they reflect light to a great extend.

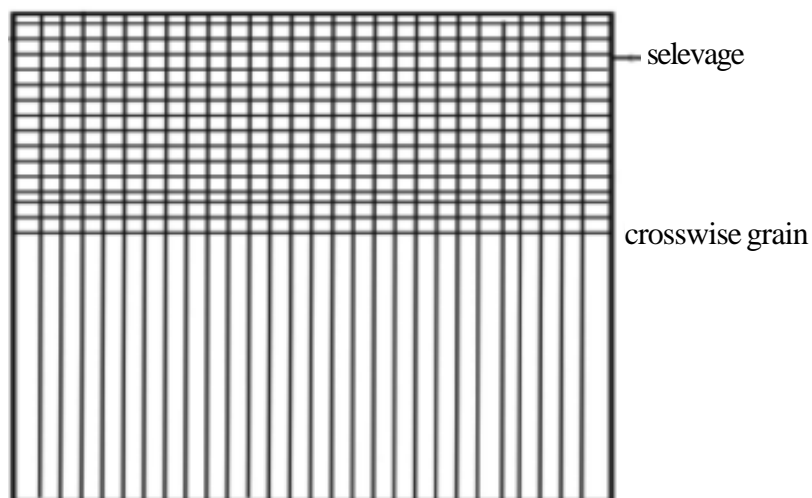
### **6.2. Identification of Grain**

Grain is a very important aspect in designing of woven textiles and garment designing. Grain play a vital role in fashion garments. Grain enhances the look and finish of both textiles and garment. Therefore, knowledge about grain is necessary for future fashion designers, garment constructors and members working with textiles.

#### **6.2.1. Grain**

Grain is described as the direction of the yarn in woven material. The yarn which runs parallel to the selvage of the fabric is called warp or lengthwise yarn. The yarn which runs perpendicular to the

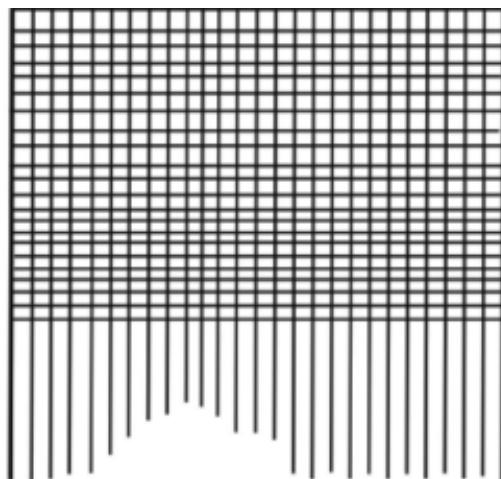
selvage is the filling or crosswise yarns. Selvage is the finished edge of the fabric. In this reference, grain is defined as the geometry or position of warp yarns relative to filling yarns in the fabric (Figure 6.1).



**Fig. 6.1. On Grain**

Depending upon the placement of the yarns, grain can be divided as on grain and off grain. “On grain” is established when the warp and weft yarns are placed at right angles to each other. On grain is also described as perfect grain. It is very important with reference to garment making, because if a pattern is cut on a material, which is not perfect, then the drape of the garment is not good, resulting in unfit.

“Off-Grain” is established when the warp and weft grain are not running perpendicular to each other. In other words the yarns are not at right angles. Every fabric is checked for grain before it is use for sewing (Figure 6.2.).



**Fig. 6.2. Off Grain**

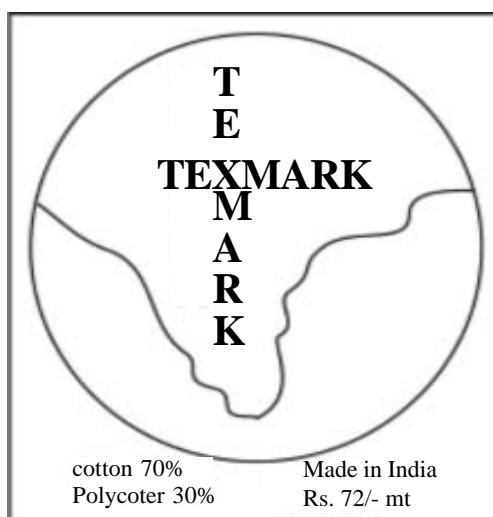
Straight grain is always used for construction garments. This gives a neat appearance and good drape. Cross grain is used for collar patterns or cup pattern of sari blouses, because they need good elasticity.

### 6.3. Identification of Right and Wrong Side

Many fabric look alike on both sides. This results in confusion for a dress maker. Some times few parts may also be cut on the wrong side and attached to the garment Eg. Pocket which is mostly cut from bits left out after cutting the major parts of the garment. This might go unnoticed but a good dress designer will find this, in a few minutes. Hence it is necessary to understand the right and wrong side of the fabric.

All the fabrics, irrespect of fiber content, variety and end use have label information. The fabric label is a print on the right side of the fabric. This includes information like type of material, cost, name of the company, brand name, symbol, government certified mark (Tex mark) and fiber content. Hence it is easy for any one to identify the right side by seeing this mark. Even on running materials, the cost and fiber content or name of the fabric is printed after every meter.

Label information (Figure 6.3.)



**Fig. 6.3.**

In case the label information is not found then careful inspection is needed to check the right and wrong side. The fold of the fabric weave, print, texture and finish can act as an guide line to identify the right and wrong side.

#### 6.3.1. Tips to identify right and wrong side

- Generally all fabrics are smoother, with less fuzzier surface on the right side.
- Woollen and rayon fabrics are always folded on the wrong side out.
- Cotton fabrics are always folded on right side out
- All woven fabrics have floats or yarns which are not used for the design interlacement on the wrong side.
- Printed fabric will look duller on the wrong side, since the printing paste is applied to the right side only. Prints are often blurred on the wrong side.

- The selvage is duller on the wrong side for most of the printed fabrics.
- Napped fabrics will have the loose yarns on the right side.
- Twill fabric will run down toward, on the right side.

#### 6.4. Stay Stitch

Stay stitch can be defined as a row of regular machine stitches, done on a single thickness of fabric between the cut edge and the seam line, about 0.2cm from the seam line. This preserve the lines and grain of the fabric as cut by the pattern. Generally it is done on curved edges like neckline, armhole line and collar patterns.

When patterns are cut on to the fabric depending upon the nature of the fabric, any edge that is cut on the bias line will stretch. This stretching can be noticed particularly in crepes and other heavy, slippery fabrics. It happens to some extent on all fabrics except like taffeta and canvas. The purpose of stay-stitching is to keep the bias edges of a garment from ravelling in other words, to ensure the exact measurements of the pattern.

One of the characteristics of lengthwise and crosswise threads of fabric is that they will not stretch; however, any slightly diagonal line is a bias line and will exhibit characteristics stretching. Such bias edges of a garment include: front and back armholes, front and back shoulders, front and back neck edges, and many other edges, depending on the design. However, there are exceptions—edges which need not be or should not be stay-stitched. Seam edges which will fit the body snugly must be stay-stitched; edges which will hang free from the body need not be stay-stitched. Stay stitching saves time for beginners.

There are several edges which need not be stay-stitched. They are:

- Edges cut on the lengthwise or the crosswise threads.
- Outer edges of facings (unnotched edges).
- The cap of the sleeve.

**How to stay-stitch:** As soon as the garment is cut, either just before or just after the tailors tacks are made, remove one pattern piece at a time and prepare to stay-stitch the necessary edges.

Stay-stitches are made through only one thickness of fabric. The stitches are done by machine with a stitch long enough to pull up if it becomes necessary to draw in the fabric to make it return to the size of the pattern. At the same time the stitch must be short enough to serve the purpose of holding the edge firmly. In most fabrics, except the heaviest of wools, this stitch should be about 1/10 inches long (10 stithes per inch). In heavy wools, the stitch might have to be 1/8 inch long (8 inches per inch) in order to be long enough to pull up.

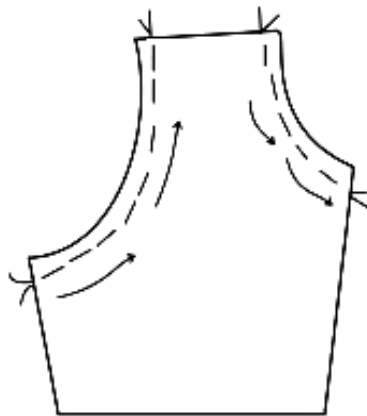
Use thread that matches the garment . The reason for this is that stay-stitches do not need to be removed after the garment is finished and a matching color will make the garment look more attractive from the inside.

The stay-stitches must be placed outside the seamline, in the seam allowance. They may be placed any where from 1/8 to 1/12 inch from the cut edge. Most authorities give 1/8<sup>th</sup> inch as the correct placement because of this advantage: if you should have to let out the seams of the garment, these stitches would not show and would not have to be removed. The 1/8<sup>th</sup> inch measurement works

very well on fabrics that are too limp and slippery. Stitches 1/2 inch from the cut edge have the great advantage of giving control very close to the seam line, where control is badly needed at the seam line. Since the stitching done through one thickness of the fabric and since the machine is keyed to stitching through at least two thicknesses of fabric, and since a longer stitch than usual is being used, the fabric is apt to pucker. This can be counteracted by a firm gentle pull on the fabric as it comes through the machine. How much to hold it and whether to pull it slightly depends on the fabric. To find out, stay-stitch one edge of a piece, holding the material so that it comes out of the machine with no puckers. Then lay the pattern piece back on the fabric and see if that stay-stitched edge is just like the pattern. If the fabric is now shorter than the pattern, then hold it more firmly as it moves through the machine; if the fabric is longer than the pattern, hold it less firmly.

Stay-stitch each edge of the fabric with separate threads, leaving just short ends of thread at each corner.

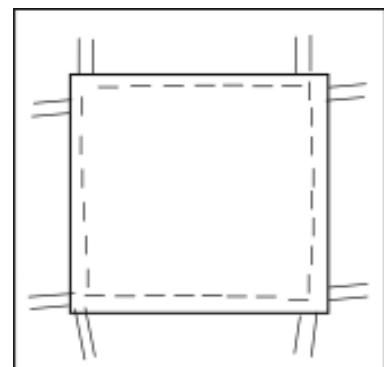
Always put every pattern piece back on the fabric and check every edge to see that it has retained the same measurements as the paper pattern. If an edge is too long, pull up the bobbin thread until that edge measures exactly the same as the pattern. If an edge has been drawn up and is too short, loosen the stitches and break them if necessary in order to achieve an exact copy of the pattern. (Figure 6.4).



**Fig. 6.4**

**6.5. Basting**

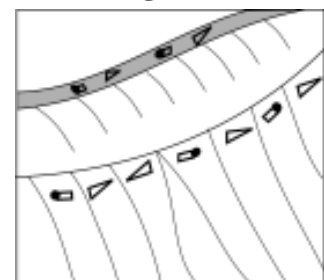
This is a term used to combine two pattern pieces, before it is machined. The pattern pieces which has to be joined are placed together pinned in position. Later small running stithces are made by hand using matching colour thread. This helps the pattern to be attached properly and prevents slippage. It also aids beginners to master smooth machining. (Figure 6.5).



**Fig. 6.5.**

**6.6. Pin Basting**

As a first step in sewing strong fabrics, pins are used. This type of basting is known as pin basting. While stitching the machine needle should not come in touch with the pins which have used for joining the fabric. Hence, we have to leave 1 cm from the seam line for using pins. This type of basting is not suitable for light weight fabrics and also for very strong fabrics like pant materials. In this type of basting we have to use bell pins, which is made for pin basting (Figure 6.6).



**Fig. 6.6**

### 6.7. Machine Basting

Sewing machine is used for machine basting. We should keep the stitch length as 6 per inch with the use of stitch regulator. This will give long temporary stitches. Then we have to increase the number of stitches per inch and do machining near the temporary stitch. After that we have to remove the temporary long stitches (Figure 6.7). This type of basting is mainly useful for beginners.



Fig. 6.7

### 6.8. Hand Stitches

Hand stitches are used to join the neck lines, armscye lines and hem lines. Even basting, uneven basting are commonly used to join the curved lines. If it is for longer use, permanent hand stitches must be made. (Figure 6.8).

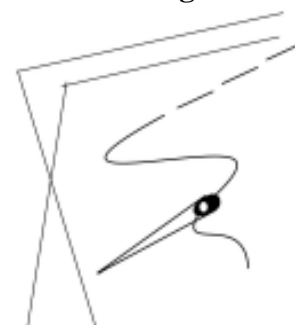


Fig. 6.8

### 6.9. Slip basting

This type of basting is used to join curved lines of a garment. This basting is done between the seam line and edge of fabric. Slip basting is very helpful for beginners. Slip basting can be machined to increase the durability of the stitches.(Figure 6.9).

Slip basting is used to join the neck lines, armscye line, shoulder line and V shaped lines. Slip basting should be done by contrast color thread, to enable us to remove after doing permanent seams.

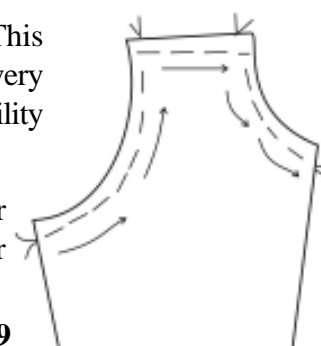


Fig. 6.9

### CONCLUSION

The aspects covered in this unit will help every one to understand fabric by mere looking and feeling. It also helps one to buy the fabric based upon ones need.

Grain stands as the life line of fabric and garment designing and construction. A clear idea about grain helps one to cut the garment pattern properly. Apart every dress designer and tailor or any one working with fabric should be able to identify both right and wrong side. This will avoid tension of shading in constructed garments that is one part alone cut and stitched on wrong side.

Preliminary stitches in garment construction helps in sewing pattern pieces together in a systematic manner. It also enhances proper shape and fit of the garment.

## QUESTIONS

### I. Choose the correct answer

- \_\_\_\_\_ fabrics are smooth to touch  
a) silk            b) twill            c) cotton            d) knitted
- Creases and wrinkles are left back on \_\_\_\_\_ fabrics after being crushed  
a) knitted            b) cotton            c) velvet            d) twill
- The finished edges of the fabrics are described as \_\_\_\_\_  
a) filling yarns            b) weft            c) selvedge            d) warp
- When the warp and weft yarns meet at perfect right angles in a fabric it is known as \_\_\_\_\_  
a) grain            b) yarn            c) off-grain            d) in-grain
- Good drape can be obtained when patterns are cut on \_\_\_\_\_  
a) straight grain            b) cross grain            c) bias grain            d) along the design lines
- Duller look is seen on \_\_\_\_\_  
a) right side of woven fabrics            b) wrong side of printed fabrics  
c) along the selvedge            d) wrong side of knitted fabrics

### II Fill in the Blanks

- Stay stitches are normally done on \_\_\_\_\_ lines.
- The shape of curved lines can be retained by \_\_\_\_\_
- Slippage of patterns during machining can be avoided by \_\_\_\_\_
- \_\_\_\_\_ can be defined as a row of regular machine stitches, done on a single thickness of a fabric.
- \_\_\_\_\_ is a term used to combine two pattern pieces, before it is machined
- \_\_\_\_\_ are sewed to join strong fabrics
- Sewing machine is used for \_\_\_\_\_
- If it is for long use, we have to put permanent \_\_\_\_\_
- \_\_\_\_\_ is very useful for the beginners, after that we have to do machining this will give permanent stitch.
- \_\_\_\_\_, \_\_\_\_\_ are commonly used to join the curved lines.
- Samples are tested in labs to find its \_\_\_\_\_ and \_\_\_\_\_
- \_\_\_\_\_ fiber have protruding fiber hair.
- Twill fabrics show a \_\_\_\_\_

14. \_\_\_\_\_ have loops or short hairy structures
15. \_\_\_\_\_ plays a vital role in fashion garment.

### **III. Explain briefly.**

1. Define grain.
2. Explain “Off-Grain”
3. Write any three tips to identify fabric by look and feel / touch?
4. Explain how to identify right and wrong side of the printed fabrics?
5. Describe In-Grain
6. What is selavage?
7. Write a short notes on basting
8. Explain slip basting.
9. Explain pin basting
10. What is machine basting?

### **IV. Explain in Detail.**

1. Explain elaborately about identification of grain and classification of the grain.
2. How will you identification of right and wrong side of the napped fabric?
3. Give a detailed account on stay stitching with illustration.

## **Answers**

### **I. Choose the correct answer**

1. silk,            2. cotton,            3. selvage,            4. in-grain,            5. straight grain,
6. wrong side of printed fabrics

### **II Fill in the Blanks**

1. Neck and armscye,            2. stay stitch,            3. Slip basting,            4. Stay stitch,
5. pins,            6. Machine basting,            7. Hand stitches,            8. Slip basting,
9. Stay stitching,            10. Even basting , uneven basting.
11. servericability and life,            12. cotton,            13. diagonal effect,
14. Napped fabrics,            15. Grain



# 7. LAYING THE PATTERN, MARKING AND CUTTING

## INTRODUCTION

Laying the pattern, marking and cutting are three important aspects for dress designing and construction. Laying the pattern deals with the aspects of placement of prepared paper pattern on the fabric to cut and sewed. Marking includes aspects like transferring the pattern lines to the fabric and cutting explains the method of piecing the fabric into patterns similar to that of the paper pattern, ready to be sew. These three concepts enhance dress making. It can be rightly called the life line of apparel designs and construction.

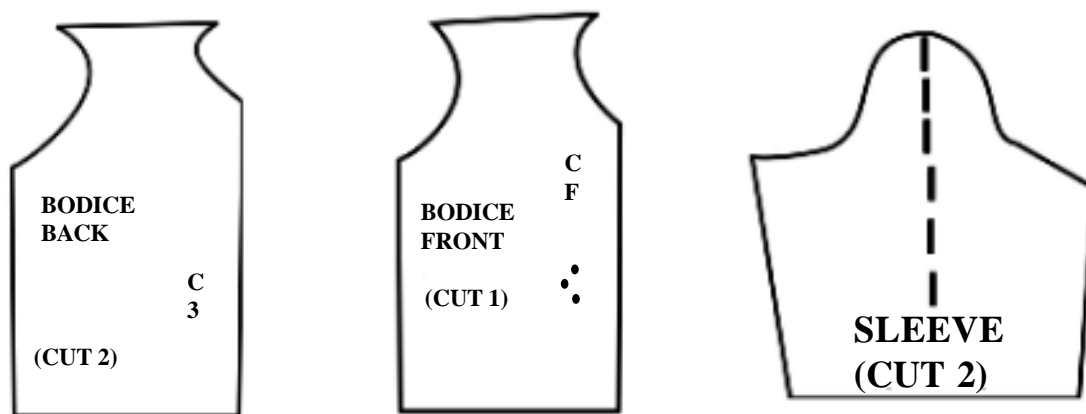
### 7.1.Laying

Laying of pattern on the fabric without crease is known as fabric laying. The prepared fabric is laid flat on the table. The paper pattern must be placed on it. The points to be considered while fabric laying are:

- Press the fabric well
- Use a large, hard, flat table for fabric laying
- Check if all the patterns have every detail
- Note the best type of layout
- Place the patterns on the right grain
- Place large pattern first, toward the edges
- Place similar patterns together
- Place the patterns close to each other to save fabric

### Pattern Detail

- Name of the pattern
- Cut number
- On fold
- Grain
- Notches
- Placement of pocket, button, button holes and other accessories
- Position of pleats or other fullnesses
- Sewing lines
- Hem folds
- Position to be gathered (Figure 7.1)



**Fig. 7.1**

### **7.1.1. Laying the Pattern**

A fabric has to be prepared well (i.e) it should be pre-shrunk and ironed before the patterns are placed on it. The fabric has to be spread neatly on a clean large table. One can even use a clean floor. Remember to use a surface bigger than fabric, so that over lapping of the fabric or mismarking can be avoided.

### **7.1.2. Different Types of Layout**

Layout has to follow a specific pattern, which mainly depends upon the type of garment, the pattern pieces and the width of the fabric. The different types of fabric layouts namely lengthwise centre fold, off center lengthwise fold, cross wise center fold, off centre crosswise fold, combination fold and open layout. (These aspects are explained in Chapter-11, Preparing fabric for sewing in +1 Theory). Hence in this chapter we will learn to handle different types of fabric like knits, velvet, pile and fabric with bold designed stripes, plaids and printed fabrics.

### **7.1.3. Pattern Laying of Special Fabrics**

Pattern laying needs extra care when the fabric vary like knits or silk. A clear knowledge about the various points to consider in laying patterns on special fabrics will help one to use the fabric economically and save time. It will also help in designing varieties in dresses.

**7.1.3.1. Knits :** Knitted fabric is a special type of fabric made by interlooping of a single yarn. There are various varieties of knitted fabrics like single and double jersey, tricot and rib. Out of these jersey fabrics are normally used for garment construction.

#### **Steps involved in preparing, marking, laying and cutting of jersey fabrics are**

- Pulling or tearing should be avoided to straighten the fabric
- Lay the folded edges straight on a flat surface or cutting table
- Cut a straight cross wide line at right angle to fold the selvage
- If the fabric is very slippery, a newspaper or butter sheet can be pinned to the fabric before laying it straight on the table

- Always place the pattern on the wrong side of the fabric, this prevents curling or rolling of the fabric
- Beginners can use thin pins to pin the patterns before marking them
- Mark the outline of the patterns using a tailor's chalk or red and blue pencil
- Open layout is best for jersey fabrics irrespective of the type of garment
- Take care to stay stitch the bias or curved edges

**7.1.3.2. Silk, Rayon, Laced Fabrics :** These fabrics are very thin, slippery and delicate. Great care is required in marking and cutting these fabrics.

**Steps to be followed in preparing, laying, marking and cutting these fabrics are**

- Pre shrinking is not required for these fabrics. They can be used directly as purchased from the shops
- To straighten the fabrics, lay them on the table and pull in crosswise direction
- Lay the fabric on a flat smooth surface. Move your figures smoothly over the fabric to remove creases. Even a clean floor can be used. Make sure that the surface is bigger than the fabrics
- A newspaper or butter paper can be pinned to the back side of the fabrics, to prevent slippage of the fabric while placing the patterns
- Place the patterns on the right side of the fabric. Right side can be identified by seeing and feeling. The right side is always brighter and smoother
- Pin the patterns along with the fabric neatly in two or three place. Take care to pin the patterns along the lengthwise grain. Make sure that yarns are not pulled off while pinning the patterns.
- Cut the pattern alone with the pinned pattern or you can mark them with the help of a tailor's chalk
- Stay stitch the curved edges, roll all the patterns and keep aside till it is taken for sewing.
- Open layout is best suited for these type of fabrics especially for beginners. One can use off-center fold also

**7.1.3.3. Velvet, Satin, Pile Fabrics :** These fabrics have loop like structure on the surface. These structures add grace to the fabric, therefore utmost care should be taken.

**Steps involved in preparing, laying, marking and cutting patterns on these fabrics are**

- Always roll these fabrics after purchase and carry it home. Leave it rolled till cutting. This prevents formation of wrinkles.
- If wrinkles are found, hang the fabric on a rod or string over a tub of hot water, such that the steam passes over the fabric. Move your fingers slightly over the wrinkles. Take care to follow the direction of the loops / pills.
- Pull the fabric gently to straighten it.
- Place the fabric with the right side facing (the loops / pills facing you) on the table.

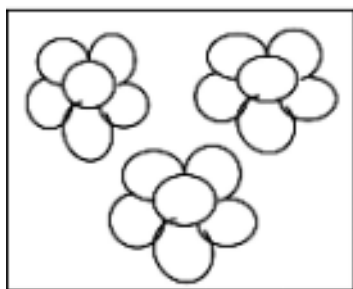
- Place the patterns. Use a tailors chalk for marking.
- Expert dress designers use needles to pin patterns in one or two places and cut the patterns without tracing it on to the fabric.
- Open layout is the best preferred for these fabrics, especially because one has to maintain the direction of grain.

#### 7.1.4. Pattern Laying Based Upon the Design

Design incorporated in a fabric should be emphasized to enhance the personality of the wearer. Hence patterns should be laid carefully to maintain the design and to harmonize it with the basic silhouette of the dress. Some of the most common types of designs and the method of laying patterns on them are discussed below.

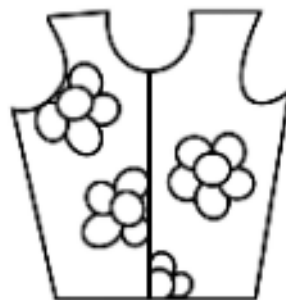
**7.1.4.1. Bold Designs :** Large motifs can be used for all sort of garments, but they look best when placed in an irregular fashion. This concept can be assure only with placement of the motifs. If a fabric has too many motifs arranged in a crowded manner or a irregular pattern, they can be placed next to each other, cut and sewed. Since the fabric does not follow a define pattern the garment will not look odd (Figure 7.2).

When the material has well designed large motifs repeated after equal distance, place these designs on to the center of the pattern. Don't cut through large motifs because it is difficult to match seam lines (Figure 7.3).



**Large Motifs**

**Fig. 7.2.**



**Wrong cutting**



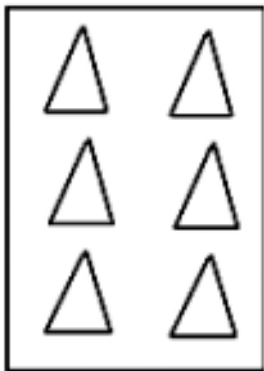
**Right cutting**

**Fig. 7.3.**

Pattern laying techniques vary based upon the designs also. So a dress designer should observe the type of design and the repeat of the design.

**7.1.4.2. One-way Design :** One way designs can be printed or woven. Design go in one direction Eg. Group of flowers on a creaper can be woven from selvege to selvage in the lengthwise direction or a group of geometrical designs can be printed (Figure 7.4).

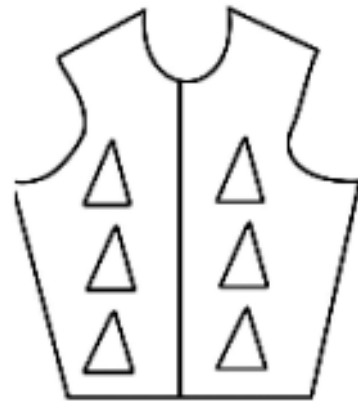
When patterns are laid on these type of fabric one must carefully check if the seam lines on one pattern match with the design of the pattern which is joined. Eg. If a blouse pattern with front opening is cut on a one way design, place the patterns in such a way that both the right and left blouse patterns are alike (Figure 7.5).



**Geometrical design**

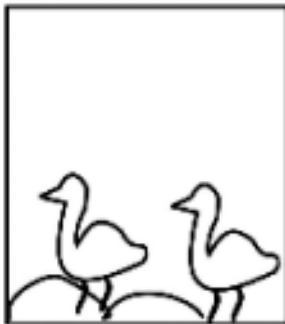


**Wrong**



**Right**

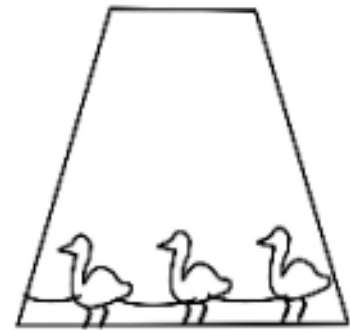
**Fig. 7.4**



**One way design**



**One way design on bodice**

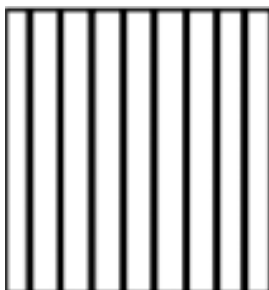


**One way design on skirt**

**Fig. 7.5**

**7.1.4.3. Stripes and plaids :** Stripes are straight lines running in the lengthwise or crosswise direction. These stripes are called as vertical stripes and horizontal stripes (Figure 7.6). Stripes are most commonly used in shirt patterns. They can be cut in lengthwise and crosswise directions to create zig-zag effects on garments. Collar, sleeve, pocket patterns can be cut in cross grain on vertically striped material to create interest to the garment (Figure 7.7).

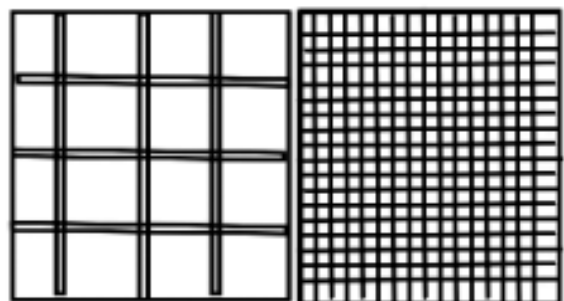
Plaids are lines woven or printed in both lengthwise and crosswise direction. Plaids create a checked effect (Figure 7.8).



**Fig. 7.6**

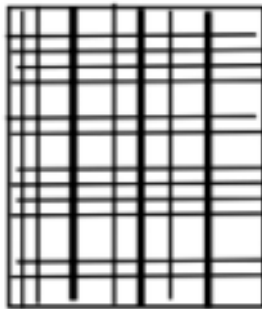


**Fig. 7.7**



**Fig. 7.8**

Stripes and plaids can be even or balanced and uneven or unbalanced. Even or balanced stripes and plaids can be described as lines or bars arranged in a definite colour or placement. The size of the bars and stripes are similar. The variation occurs in the type of yarn or colour of the yarn used (Figure 7.9). Uneven or unbalanced is just the opposite. Here bar and stripes of different sizes, colours and spacing are arranged in a systematic manner (Figure 7.10).



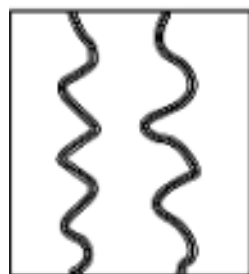
**Fig. 7.9**



**Fig. 7.10**

**7.1.4.4. Border Designs:** These designs run along one selvedge only. They can be woven or printed. The design can be used along the hem lines of the bodice, skirt and sleeve patterns. In order to maintain the design line some patterns like yokes and collars are to cut on straight grain. These fabrics cannot be used for curved edged garments like flared skirts. One must make sure that the hemlines are straight to follow this design. While placing pattern on these designed fabrics. One must take care to match the designs. Eg. the front and the back bodice pattern must have the same thread of design at the side seam but it need not be similar in case of abstract designs. (Figure 7.11).

Open layout out or off center lengthwise layout will suit these type of fabrics.



**Zig zag lines**



**Patterns are cut Symmetrically**



**Abstract designs**



**Patterns need not be cut symmetrically**

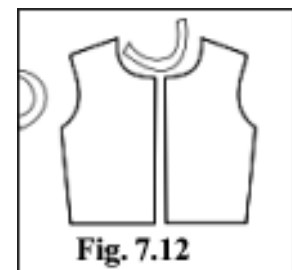
**Fig. 7.11**

### 7.1.5. Economical Pattern Placement

Economical pattern placements in other words means the correct layout on the fabric in hand, rather making the best use of the fabric.

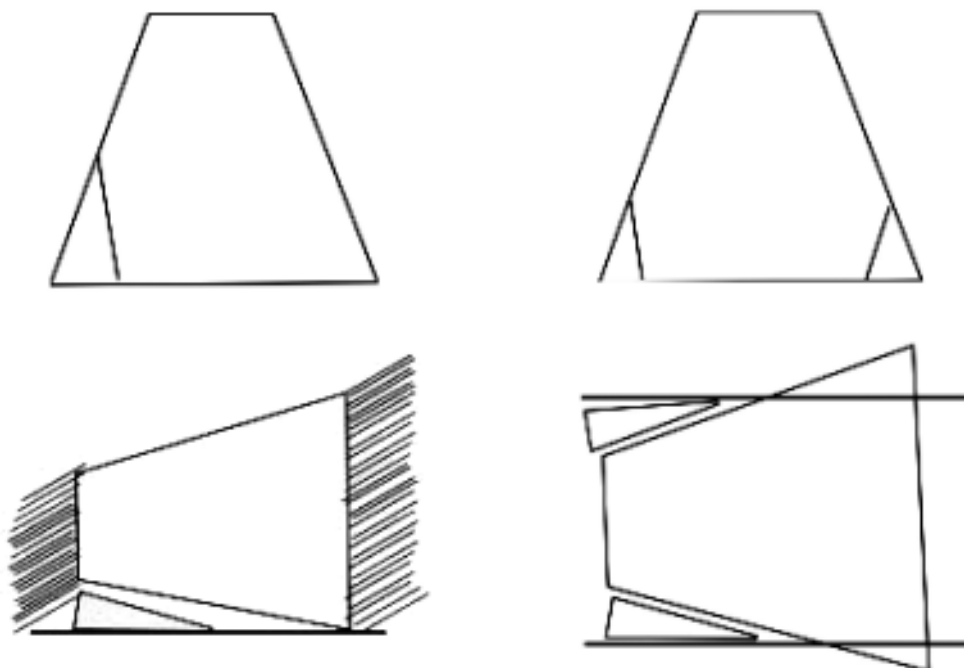
#### Principles for Economical Layout

- Never mark or cut any pattern until trial shows the best location for all pieces.
- Make temporary placement using small weights.



**Fig. 7.12**

- Begin with the largest pattern pieces at opposite ends of the cloth and work toward the center to fit in smaller pieces.
- Place the wider ends of the patterns at the cut ends of the fabric.
- Place all pieces close to each other so that you can save material which may be used for fullness of the same garment or used for making accessories like hair bands, rings etc.
- Cut notches outward if possible or inward if material is not enough.
- Follow 'Dovetailing' technique for pattern laying. Dovetailing is placement of similar shaped patterns together. For example a collar pattern can be placed closer to the armscye line. This will help one to save fabric. (Figure 7.12).



**Fig. 7.13. Piecing**

- In case the fabric is insufficient for a pattern, then a small piece of fabric can be added to the fabric, at the part where the pattern extends beyond the fabric. This technique is called as piecing. Balance the pattern and add small bits on either side of the pattern, which will result in good drape. Example: The tip of a skirt hem might extend beyond the fabric, then place the pattern in the center such that small pieces can be added on either sides (Figure 7.13).

## **7.2. Marking**

Marking is the process of transferring the pattern lines and details like darts on to the fabric. It can be done using different methods like red and blue pencils, tailor chinks, pencil and carbon paper.

### **Points to be considered while Marking**

- Check if all the pattern details are marked.
- Check if there is sufficient material for the garment

- Select suitable method of marking Eg. Tailor's chalk for patterns with cutting lines only, pencil and carbon paper to mark patterns for beginners, because sewing line can be marked.
- Don't mark using lead pen because it leaves black marks on the pattern.

### 7.2.1. Red and Blue Pencils

A mark pencil, which is half red and half blue is normally used to mark the patterns. The red lines are used for front patterns and blue lines are used for back patterns. The patterns are placed on the fabric and out lines are marked along the edges. It is the simplest and easiest method of marking. The main disadvantage is the pattern details, like darts, sewing lines can not be marked (Figure 7.14).

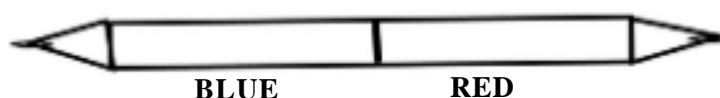


Fig. 7.14

### 7.2.2. Tailor's Chalk

This is one of the easiest and simplest techniques of transferring the pattern details on to the fabric. Tailor's chalk is a triangle coloured wax available in dark and light colours, namely white, blue, red and yellow. Red and blue chalks are used on light coloured fabric, white and yellow are used on light coloured fabric. The pattern is placed on the fabric and the out line is drawn using the tailor's chalk. The main disadvantage of this technique is that the pattern details, sewing lines cannot be marked (Figure 7.15).



Fig. 7.15

### 7.2.3. Pencil and Carbon Paper

This is an oldest method of marking the patterns where a carbon paper is placed in between the pattern and fabric. Then the pattern outline and details are drawn using an ordinary pencil. In this technique the sewing line and dart can also be transferred.

### 7.2.4. Tracing Wheel and Dressmaker's Carbon Paper

Professional dressmakers often use tracing wheel and dress maker's carbon paper. This carbon paper comes in yellow, red or white. It does not get rubbed easily. White is best to be used, red or yellow can be used for marking on white or cream coloured fabric. A tracing board is required to mark patterns with a tracing. This board is a heavy unglazed cardboard. It can be purchased or homemade with help of a carpenter. It can also have a scale marked along one edge to enable us to place the fabric straight. Beginners can use pins to pin their pattern on to the board. Tracing wheels are available in markets. It is a six inch long device with a wooden or plastic handle at one edge and a small one centimeter moveable wheel at the other. The wheel is designed with finely shaped points.



Fig. 16

To mark the patterns, one should place the fabric firmly on the tracing board. Confirming the position of the patterns, insert the dressmaker's carbon slowly in between the pattern and the fabric. Move the tracing wheel over the cutting and sewing lines neatly. Small dotted lines are marked on to the fabric (Figure 7.16).

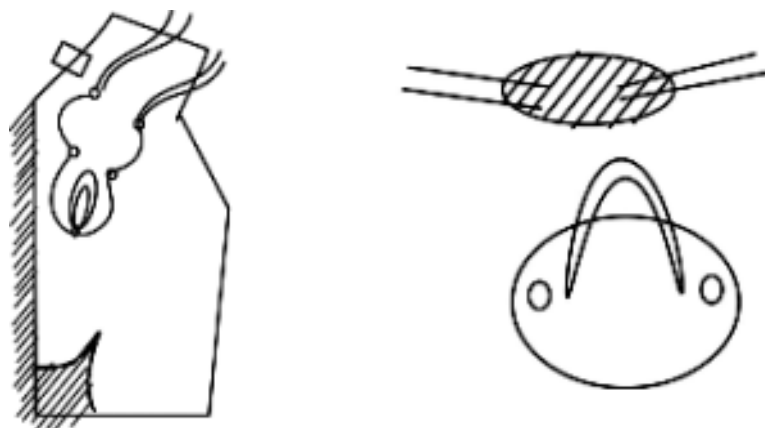


### Tips for Effective Use of the Tracing Wheel

- Mark each corner as true angles by tracing the adjoining seams with separate strokes clearly out to cross each other.
- Never remove patterns, if the carbon is insufficient. First trace the lower pattern part. Then move the carbon holding the pattern with a thumb.
- Long, straight lines can be marked by placing a scale on the line and moving the tracing wheel smoothly.
- Notches can be marked with a centimeter long slash.

### 7.2.5. Tailor's Tacks

This type of marking the patterns are suited for thin and delicate fabrics like silk. It is of great help to beginners because it marks the right and left sides and the right and wrong sides at the same time and at the same location. It is fairly permanent and visible from both sides. It can be described as long tacks or running stitches along the pattern lines through the pattern and fabric to hold the both together. Contrast colour cotton thread are used for tacking (contrast colour means if the fabric is light colour darker colour threads). For example to tack a pattern on a red colour fabric, pink, yellow, orange, blue, black or white colour threads can be use. This thread should be conspicuously seen on the fabric. (Figure 7.17).



**Fig. 7.17. Tailor's tacking**

**Tailor's tacking can be done following the steps given below:**

- Place the fabric on a flat smooth surface.
- Check the patterns and place it in the most economical manner.
- Take a long double contrast colour thread on a fine needle.
- Prick the needle through the pattern into the fabric and make small running stitches.
- Leave long loops between the two stitches made.
- Move around the pattern and tack the whole pattern neatly.
- After all patterns are tacked, cut the threads or loops between the stitches.

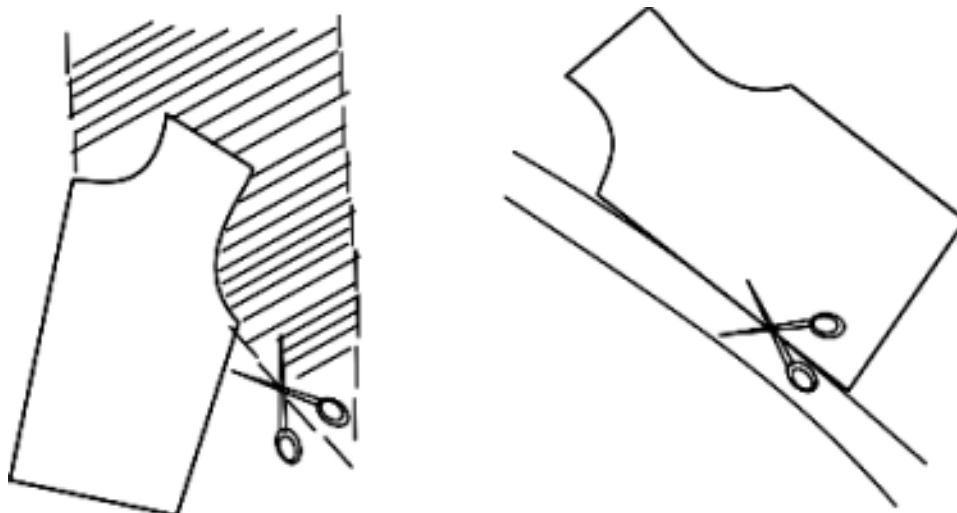
- Remove the patterns gently. Care should be taken to leave the cut threads at the points where stitches are made.
- These threads act as dotted lines showing the pattern on the fabric to be cut.
- Open layout and combination layout can be marked using tailor's tacks.

### 7.3. Cutting

Cutting is the method of piecing the fabric into suitable sizes, such that can be sewed together to form a neat garment. Cutting requires sharp shears (Figure 7.18).

#### Steps involved in cutting a fabric are:

- Keep the ends and sides of the material parallel with the table edges while cutting, so that the grain never shifts.
- Hold the fabric firmly in the left hand at the point where it is cut and cut using right hand.
- Cut the fabric using long, smooth strokes to the full length of the shears.
- Don't lift the fabric very high from the table.
- Try to move around the table and cut the fabric.
- If the fabric is pulled, the grain of the garment pattern will change.
- Cut on accurate lines
- Notches should be cut wherever necessary. Cut it outwards.
- Do not remove the pattern until you have all patterns cut.
- Discard small scraps and collect those you wish to save in a neat bundle. Clean up the table and floor.



**Fig. 7.18. Cutting**

### 7.3.1. Factors to be considered while cutting special fabrics

1.	Short nap	Eg. corduroy, velveteen - cut nap going up ward. Exception - broad - cloth nap is down ward.
2	Long nap	Cut nap down ward - hair coating
3	One way design	If a print is designed to go in one direction, then even' piece of garment is cut in that direction.
4	OIF grain design	If the print is stamped off grain then the garment to gain, avoid purchase of these garments.
5	Plaids and stripes	Matching is necessary. Plaid design should be complete within $\frac{3}{4}$ or less inches.
6	Pile	Place together the smooth or wrong side of the fabric.
7.	Sefevage	Rarely is it necessary' to act of selvage before cutting out a garment. Use it wherever possible as a seam finish. I fit appears to be tight or drawn in some fabrics. Strip it at intervals. Interesting selvage is often used as a trimming detail on right side.
8	Fabrics of manmade fibers	The choice of a pattern for many fabrics of man-made fibers must be made carefully for these fabrics will not produce a tailored looking garment nor will retain flat seams & sharp edges is pressing.
9	Stiff labrics	Eg. silk taffeta, are resistant to molded lines in garments eg. set in sleeve, select pattern care full).
10	Corduroy	Don't stunk, heat of a clothes dries may strink it. but no shrinking process for fabric would withstand the shrinkage of a very hot clothes dries.
11	Large prints	Avoid buying prints that are not correctly aligned with fabric grain. Cut along the direction of the prints - Eg. Flower Motifs should be lacing upward.

### CONCLUSION

Laying, marking and cutting are three very important aspects in garment construction, if it is done carefully, beautiful garments can be sewed to perfect fit in an economical manner.

## QUESTIONS

### I. Choose the correct answers

- Hot steam from a bucket of water can be used to remove wrinkles from \_\_\_\_\_ fabrics  
a) velvet          b) knit          c) cotton          d) silk
- Placement of similar patterns are known as \_\_\_\_\_  
a) piecing          b) dovetailing          c) center front fold          d) pattern laying
- Fabric should not be lifted high from the table while cutting because it might result in mishandling of the \_\_\_\_\_  
a) design          b) pattern          c) grain          d) darts
- Tailor's tack is best suited for \_\_\_\_\_ fabrics.  
a) cotton          b) knitted          c) twill weave          d) silk
- Bordered fabric can not be used for designing \_\_\_\_\_ garments.  
a) flared skirts          b) jabla          c) A-line frocks          d) shirts
- It is impossible to tear or pull threads to straighten \_\_\_\_\_ fabrics  
a) velvet          b) knitted          c) silk          d) lace
- Contrast colour threads should be used for \_\_\_\_\_  
a) straightening          b) marking          c) tailor's tacking          d) bias stitching
- Bordered designs can be best used on \_\_\_\_\_  
a) center of bodice patterns          b) necklines  
c) waist line          d) hem lines of sleeves and bodice patterns

### II. Fill in the Blanks

- Blue lines are used to mark \_\_\_\_\_ pattern.
- Yellow and white coloured tailor's chalk is used for marking on \_\_\_\_\_ fabrics.
- Placement of pattern on the fabric without creasing is known as \_\_\_\_\_
- \_\_\_\_\_ is the process of transferring the pattern lines and details like darts on to the fabric.
- \_\_\_\_\_ lines are used for marking front patterns.
- \_\_\_\_\_ is an oldest method of marking the patterns into fabric.
- \_\_\_\_\_ is a triangle shaped wax used for marking.
- \_\_\_\_\_ is the method of piecing the fabric into suitable size.
- Which marking material is used for beginners?

### **III. Answer in Short**

1. Explain Layout
2. What is role of red and blue pencil in marking.
3. List the colours available in tailor's chalk
4. What is the advantage of using carbon paper for marking patterns?
5. Define fabric laying.
6. Explain marking.
7. List out different materials used for marking.
8. What are the advantages of carbon paper.
9. Explain cutting.
10. What are notches?.
11. Write about hem folds.
12. What are the colours available in tailors chalk?.
13. What is tailor's chalk?.
14. Describe Jersey fabric.

### **IV. Answer in Detail**

1. Explain marking using pencil and carbon paper
2. List the steps to be followed while cutting a fabric.
3. Explain red and blue pencil and carbon paper.
4. Draw and explain the pattern details.
5. What are the points to be considered while fabric laying?.
6. What are the major steps in cutting?.
7. What are the points to be considered while marking.?
8. Write short note on bold designs.

### **V. Explain in Detail**

1. Explain briefly marking using Tailor's chalk.
2. With suitable diagrams explain stripe and plaid fabrics.
3. Lay a pattern on border design and explain.
4. How will you mark using Tailor's tacks?.
5. Brief on Economical layout.

6. List the effective use of a tracing wheel.
7. Draw and explain Pattern details.

## **Answers**

### **I. Choose the correct answers**

1. velvet
2. dovetailing
3. grain
4. silk
5. flared skirts
6. marking
7. tailor's tacking
8. hem lines of sleeves and bodice patterns.

### **II. Fill in the Blanks**

1. Blue
2. Dark colour fabric
3. Fabric laying
4. Pencil and carbon paper
5. Red
6. Pencil and carbon paper
7. Tailor's chalk
8. Cutting
9. Tailor's chalk.

## 8. PATTERN ALTERATION

### INTRODUCTION

Patterns are made according to standard measurements which are based on average sizes. Few figures are fortunate enough to be a perfect average. It is necessary for most women to ensure the pattern in one or more places to ensure a good fit. Fitting can be eliminated or greatly simplified by accurately adjusting the pattern to the correct body measurement before cutting the garment.

In pattern alteration, preserve the pattern out line wherever possible. This is best accomplished by using slash and spread or fold method, and the result is a permanently altered pattern that can be used over and over again.

### 8.1. IMPORTANCE OF ALTERING THE PATTERN

If the pattern is altered before the fabric is cut, there will be no adjusting in the final fitting. Make each adjustment necessary in the flat pattern tissue to save time and avoid ripping later.

Keeping records of pattern alterations and their effectiveness is the way to perfect individual requirements. If this is done for several garments accurate requirements will be established to such an extent that one need not go through any of the pattern measurement steps.

### 8.2. STANDARDS FOR ALTERED PATTERNS

1. Original grain-lines are preserved.
2. Patterns are kept in proportion and balance.
3. Change is created only where needed and is not obvious.
4. Designer's lines are preserved.

### 8.3. BASIC RULES

**The first basic rule:** All corresponding pieces must be altered to correspond with the alterations on the major piece.

**The second basic rule:** Additions or extensions must be made by taping an extension strip to the edge involved.

**The third basic rule:** Altered patterns must have the same character as the original pattern piece.

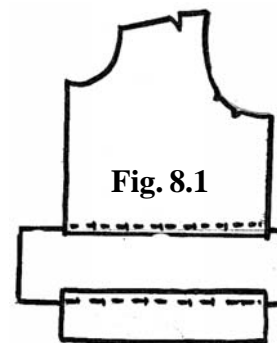
**The fourth basic rule:** Correct distortions on altered pattern to give the altered line the same character as the original line.

**The fifth fundamental rule:** The altered pattern must be perfectly flat, like the original pattern piece.

### 8.4. PATTERN ALTERATIONS FOR BASIC FIT PROBLEMS

Some of most common fit problems are increase or decrease in height and width. Alterations in these problems increase the life of the garment.

**8.4.1. To lengthen blouse:** Draw a line across the front and back sections, half way between the underarm and waist line. Place a strip of thin paper under the pattern and pin just above the line. Slash and separate the pattern sections the needed length. Pin the lower sections to place on the paper. Keep the center front and back lines straight. Trim the side cutting edges even across the alterations. Length must never be added to the lower edge of a blouse. (Figure 8.1)



**8.4.2. To shorten blouse:** Draw a line across the pattern sections as instructed above. Measure the amount to be taken out and draw a parallel line. Fold the pattern on the lower line and pin to the upper line. Pin a small piece of paper under the fold at the side edge and mark the cutting edge as shown by lines in the illustration. (Figure 8.2)



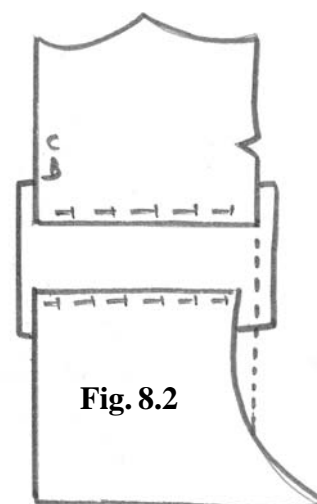
**SHORTEN BLOUSE**

**Fig. 8.2**

**8.4.3. To lengthen skirt:** Draw a line across the skirt back, well below the hipline, at right angles to the straight grain. Slash the pattern and separate the necessary amount. Pin the slashed edges, to a strip of thin paper, keep the center grain-line straight. Mark the cutting line on the side as shown by the dotted lines.

Make the same alteration on the skirt front section. When a skirt section is not to be cut on a fold of the fabric, be careful to keep the grain- line straight. Mark new cutting lines on both sides of each pattern sections.

If increased width is desired around the lower edge of skirt; add the needed length at the hemline. To lengthen on extremely flared skirt, add the necessary length at the hemline. The skirt will hang properly because the increased fullness is in proportion to the added length (Figure 8.3)



**LENGTHEN SKIRT**

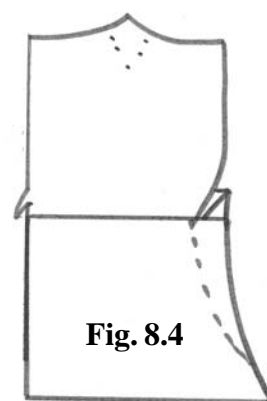


#### 8.4.4. To shorten skirt

Draw two lines across the skirt back sections, well below the hip line, indicate the amount to be shortened, keep these lines at right angles to the center fold grain-line. Pin or tuck across the pattern by bringing the two lines together.

Shorten the skirt front in the same manner. Trim the extended edge of the pattern below the fold as shown by the dotted lines. To shorten an extremely flared skirt, cut off excess length at the hemline. This will reduce the width of the skirt, but the original hand of the skirt will remain the same.

The original width around the hem line of a flared or circular skirt can be retained by shortening the skirt just below the hipline. (Figure 8.4.)



SHORTEN SKIRT

#### 8.4.5. To lengthen sleeve

Draw an extended line through the straight grain perforations and mark the position of the elbow opposite the center dart. Compare the individual measurements to those of the pattern from shoulder to elbow, and elbow to waist, to determine the amount needed above and below the elbow. Separate the pattern pieces the necessary amount and pin to strips of paper. Trim the cutting edges even. (Figure 8.5)

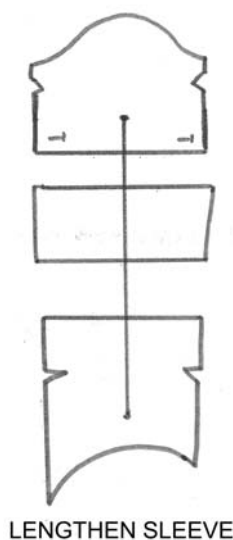
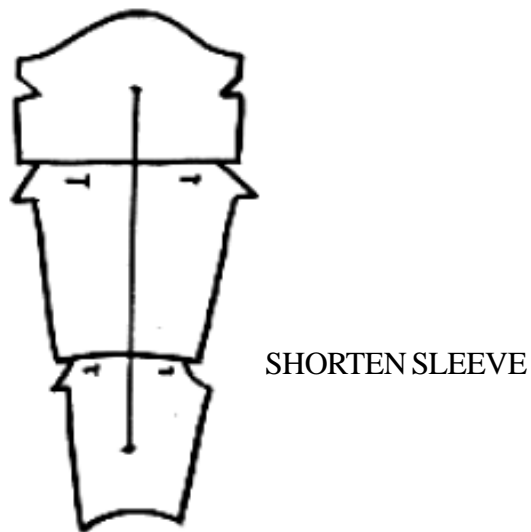


Fig.8.5

#### 8.4.6. To shorten sleeve

Mark the position for alterations and compare individual measurements, to determine the amount of adjustment. Take stitches across the pattern, decreasing the sleeve the necessary amount. Keep the grain line straight. Mark the cutting edge as indicated by the dotted lines.

Two piece sleeves and straight full sleeves can be shortened or lengthened across the elbow in one alteration. (Figure 8.6)



**Fig. 8.6**

**8.4.7. To alter shoulder width**

The width of the shoulder is determined by the location of the armhole line, which is the arm hole seam if the garment has a sleeve or the seam-line of the garment is sleeveless. The ideal location of armhole line is difficult to establish because there is no well defined line on the figure to indicate a precise division between shoulders and arms. The ideal location can be identified. The armhole line at a point, where the sleeve is comfortable and provides proper freedom of movement and, at the same time, creates a pleasing dividing line between the shoulders and arms. If the garment is sleeveless, the armhole line must be visually attractive, revealing neither too little nor too much of the bare arm.

Women with very wide or very narrow shoulders are well aware of their figure irregularities, but these with slight problems may be unaware that a small alteration would be helpful. Shoulder width can be adjusted during fitting, shoulders can be narrowed quite easily at that time, and they can be made wider by cutting out some of the seam allowances on the garment sections.

The amounts of alteration in shoulder width are relatively small one can consider ¼” of alterations will be required for a small figure and ½” alteration can be considered for a large figure, and an alteration of as much as ¾” for an unusual figure. (Figure 8.7)



**Fig. 8.7**

#### 8.4.8. Widen shoulders

To widen the shoulder the following steps must to be followed.

- Draw a line across the back bodice pattern and cut within shoulder line on back parallel to center back up to 1 inch below bust line, then cut straight, almost to under arm seam.
- Place back pattern on new paper and spread cut section to desired shoulder width and pin into position.

Draw a line from neck edge to shoulder tip for new shoulder line. The front of the pattern must also be made wider to care for the shoulder width, so the same width alteration must be made on the front pattern to match the back alteration. Repeat exactly the same alteration on the front jacket, in the same position from armscye.(Figure 8.8)

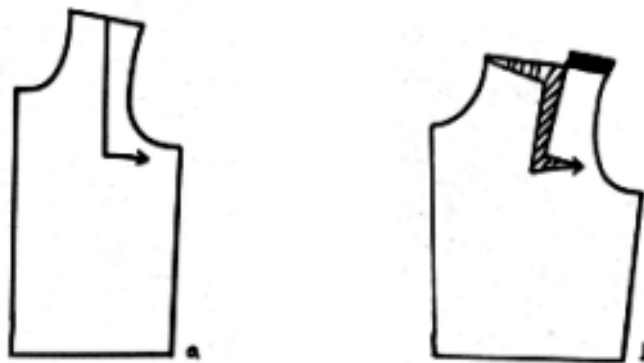


Figure 8.8

#### 8.4.9. Narrow shoulders

- Narrow shoulder can be modified by drawing a line within shoulder line on back parallel to center back to one inch below bust line, then straight out almost to under arm seams.
- Place on new paper and overlap, cut the marked section on back to desired back width and pin into position. Draw line from neck edge to shoulder tip for new shoulder line.

Repeat exactly the same alteration on the front bodice pattern. Draw new shoulder line from neck edge to shoulder tip. Fill in or cut away surplus seam (Figure 8.9).

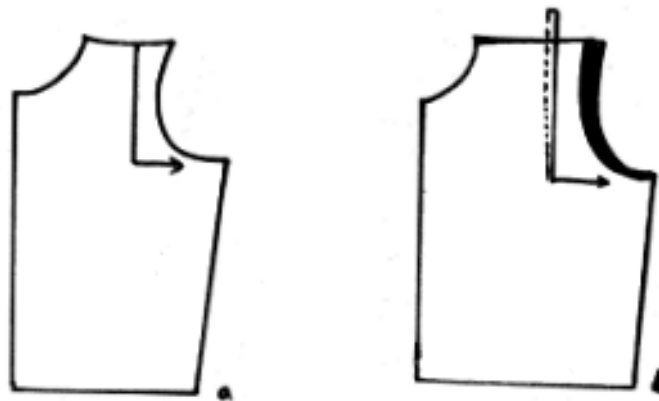


Fig. 8.9

#### 8.4.10. Widening waist back

Slash waist pattern from waist line but not through the shoulder seam. Then slash cross to the armhole notches. Spread the vertical slash till the desired amount. But don't spread at waistline. This causes the edges of the crosswise slash to overlap and shortens one side of the lengthwise slash to correct waistline seam.

In order to check if the basic alternation namely lengthening, shortening, widening and narrowing are correct, one can identify the characteristics of the patterns (Figure 8.10).



Fig. 8.10

### 8.5. Characteristics of Pattern Alteration

One must take great care to change the patterns, without disturbance of the nature or character of the pattern. One can even check the character of modified pattern to match with the original.

#### 8.5.1. Characteristics of patterns altered in length

- Patterns are shortened by cutting pattern into two parts and lapping edges evenly.
- Patterns are lengthened by cutting pattern into two parts and spreading apart, evenly, slashes are made at right angles to marked lengthwise grain lines.
- Where an edge is lengthened or shortened, corresponding edges are altered to match.
- Changes are made within the pattern, between joints where the body moves.
- Transitional lines are drawn to correct lines broken in making tucks or slashes across slanting or curved edges.
- Construction details are avoided if possible, in making changes.

#### 8.5.2. Characteristics of patterns changed in width

- Changes are made within the pattern, or slight changes are made on silhouette edges, where designer's lines are simple and fairly straight.
- Small alterations are made in several places rather than all of the change in one or two places.
- Changes affecting small areas of a pattern are accomplished by slashing. Only, as far as necessary cutting to the nearest seam line or corner.

## 8.6. Pattern alternations for figure irregularities

Pattern alternation plays a very important role in designing and constructing well fitted garments for individuals with varied figures irregularities. Some of the most common figure irregularities are big or small busts, flat chest, big or small hips, round neck, square shoulders, high abdomen and waist lines . Generally the basic patterns are modified to suit these figure irregularities.

### 8.6.1. Full busted figure

If the waist line is the right length at the back and sides not short in front directly under the bust, the figure needs more cupping for the bust than the pattern allows (Fig.A)

Cut along the alternation line and lengthen the front waist the necessary amount. Pin a piece of fabric there. At the bust dart take in the amount added to the front length, making the dart (Fig.B). This will give more cupping for the full bust, and since nothing has been done to the back and sides, the seams will be even. The side seam dart should run directly toward the point of the bust, and must be not less than an inch from the bust (Fig.C).

Make the entire dart higher or lower if needed. Always be sure that the bust darts run upward to give a younger and more youthful lift to the bustline for the full-busted figure (Figure 8.11).

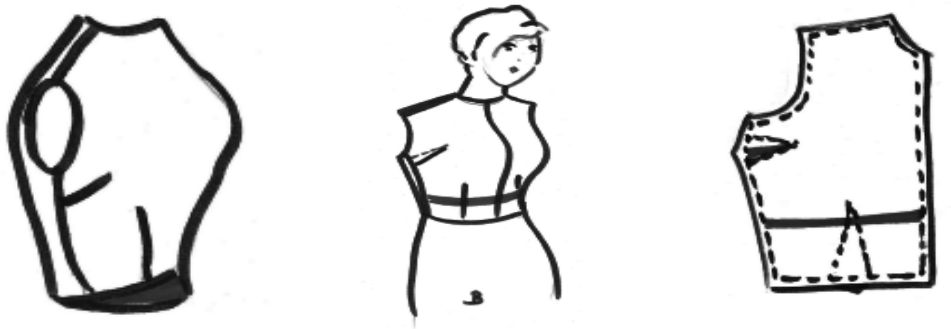


Fig. 8.11

### 8.6.2. Flat-chested figure

Usually with this figure fault, the back length is correct, but the front waistline is too long and droops at the center front (Fig.A). Eliminate the extra length by taking a dart from under the neckline, tapering to nothing towards the armhole (Fig.B). Make the same adjustment in the pattern (Fig.C) (Figure 8.12).



Fig. 8.12.

### 8.6.3. Small – Busted figure

For this figure the amount of fullness over the bust line is more than needed (Fig.A). If the shoulders are narrow as well, take a tuck from the top of the shoulder straight down towards the waistline, eliminating the extra fullness (Fig.B). If the shoulders are normal, and only the bustline has to be made smaller, a dart can be fitted from the waist line upto the notch at the front armhole of your basic muslin. Transfer these same alterations to your pattern (Fig.C) (Figure 8.13).



Fig. 8.13

### 8.6.4. Small-Busted, Flat-chested Figure

This figure requires a combination of alterations (Fig.A). Fit the same dart used to adjust for the flat – chested figure to eliminate the extra length at the front waist line. Follow the instructions at left to correct for the small bust (Fig.B). Make the same corrections in the pattern (Fig.C) (Figure 8.14).



Fig.8.14

### 8.6.5. Full-Busted, Flat-Chested figure

As the full-busted figure becomes round-shouldered, the chest becomes flat (Fig.A). Follow instructions for full-busted figure, lengthening the front and take up the dart. Then alter as for flat – chested figure (Fig.B). Transfer the directions to the pattern at the same points (Fig. C) (Figure 8.15).



Fig. 8.15

### 8.6.6. Round Neck

The back waistline will sum too short at the center back (Fig.A). Slash the back from under the back neck across toward each arm hole. Open the necessary amount, insert a piece of fabric and pin into place (Fig.B). When more than one and a half inch is needed, the figure is generally very round-shouldered and needs more fitting.

Slash as before then slash through the center of the shoulder dart and spread as shown (Fig.C). This makes the back longer, and gives a deeper dart which shapes the shoulders to take care of a more rounded back (Figure 8.16).

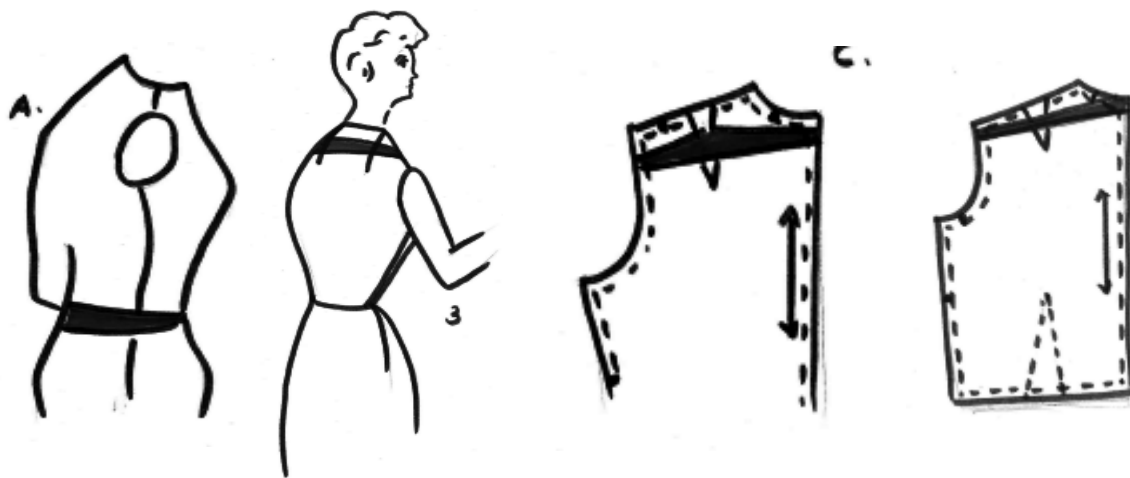
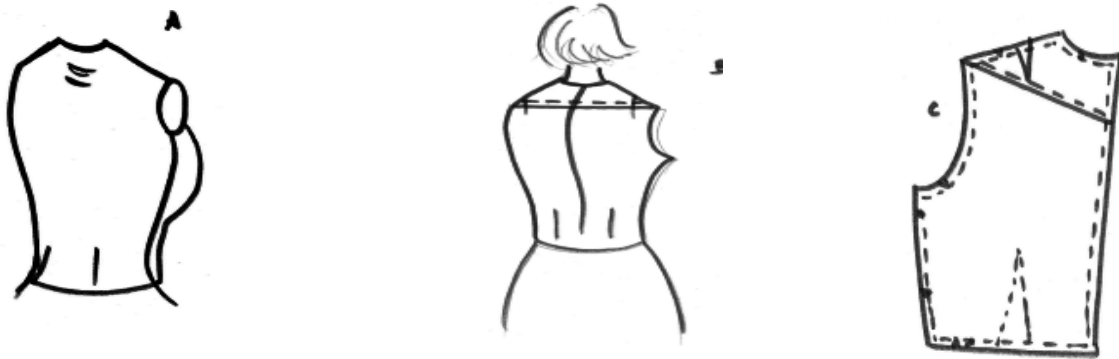


Fig. 8.16

### 8.6.7. Too Erect Figure

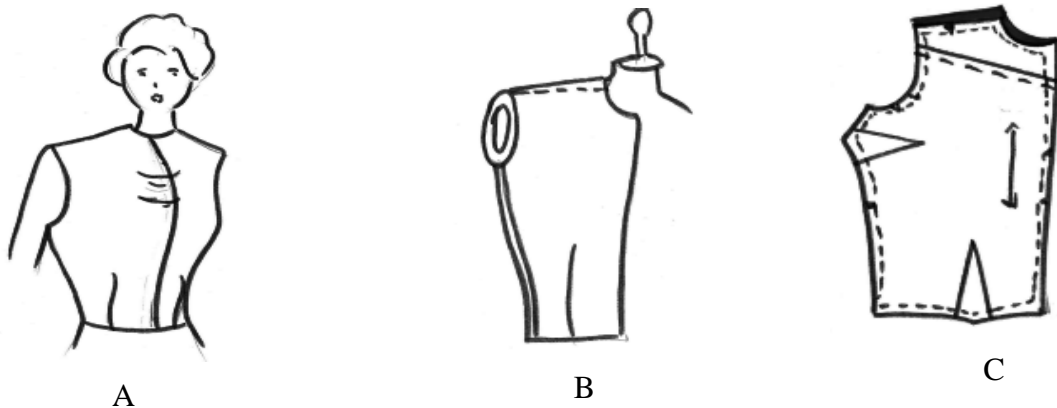
The back waistline is too long at the center back (Fig. A). To eliminate this length, pin a dart under the back neckline tapering to nothing toward the armholes (Fig.B). Make the same adjustment in the pattern (Fig.C). Take care in altering the basic pattern at points below the neck and towards the armhole is also necessary for other types of figure faults. For instance; sloping shoulders, square shoulders or round shoulders all require variations of this same adjustment. For this, clothes must hang from the shoulders. When you put on a garment, the slope of the shoulder must be the same as your own (Figure 8.17).



**Fig. 8.17**

### 8.6.8. Square shoulders

If your shoulders are more square than the pattern allows, you will find that when you put on your pattern, the top of the armholes will hit your shoulder first and the neck will be too high (Fig.A). This extra fabric will drop and the front of the dress will seem to sag (Fig B). The dart used across the front will change the slope of the shoulders to fit yours, and the dress will hang correctly (Fig.C). If a fold forms under the back neckline, use the same adjustment there (Figure 8.18).



**Fig. 8.18**

### 8.6.9. Sloping shoulders

If the shoulder of your garment fits at the neck, but not at the top of the arm (Fig.A), if the fabric drops, raising folds to form under the arm, and along the armhole seams (Fig.B), slash from under the neck toward the armhole to correct this (Fig.C). Notice that all adjustments are done within the basic pattern of the shoulder. To make back and front shoulder fit, it is usually necessary to make a dart at the back shoulder. This takes up the extra fabric, so front and back shoulder seams are even (Fig.C) and give a better fit to the rounded back.If the entire back is too broad, the pattern can be slashed from the waistline to shoulder and spread (Figure 8.19).



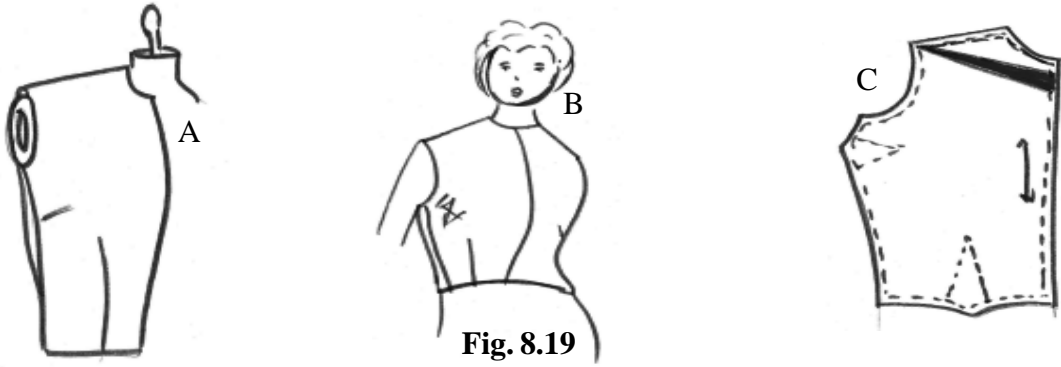


Fig. 8.19

### 8.7. Combination of both types

The overweight or matronly figure may have a combination of these figure problems. The bust may be too low and full, although and the shoulders are narrow. The back may be fleshy and rounded through the shoulders (Fig.A). Choose a pattern that provides a high armhole and alter for the broad back (Fig.B) and low full bust (Fig. C). For the low bust, lower the side darts. Mark these darts before you slash your pattern to alter for the full bust.(Figure 8.20)

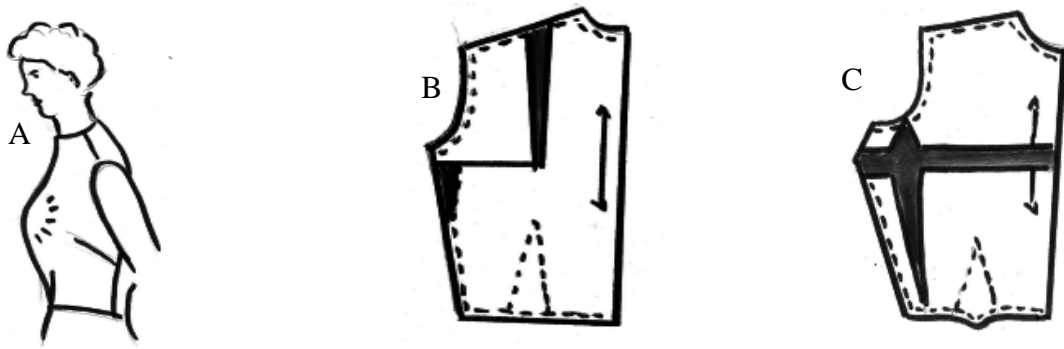
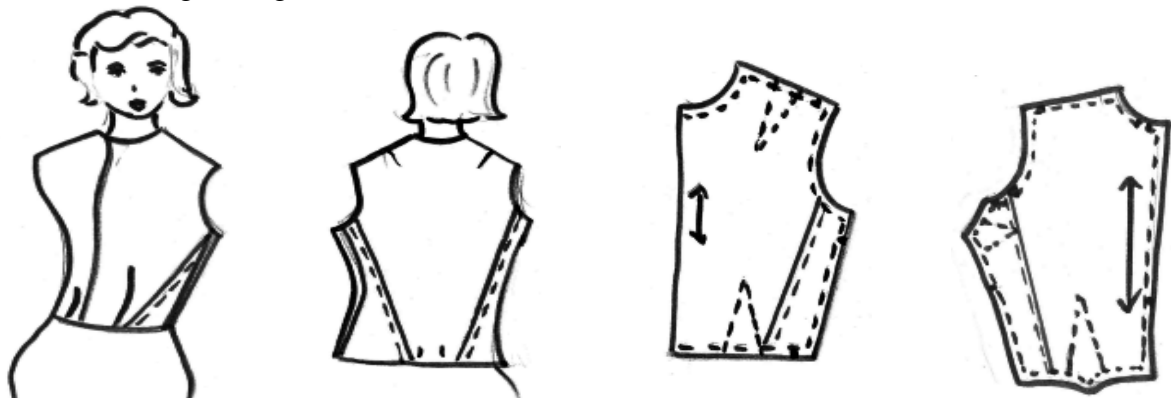


Fig. 8.20

#### 8.7.1. Decreasing the waistline

Before adjusting the waistline for size on your muslin, check the underarm seam-line. It must be straight up and down, pulling neither to front nor back. If the waistline is too big, take a dart on both the back and front bodice from waistline towards armhole, to give a snug fit (Fig.A). Pin the dart in back and front bodice pieces at the same points. The dart shapes toward the armhole but does not alter the armhole size (Fig.B) (Figure 8.21).



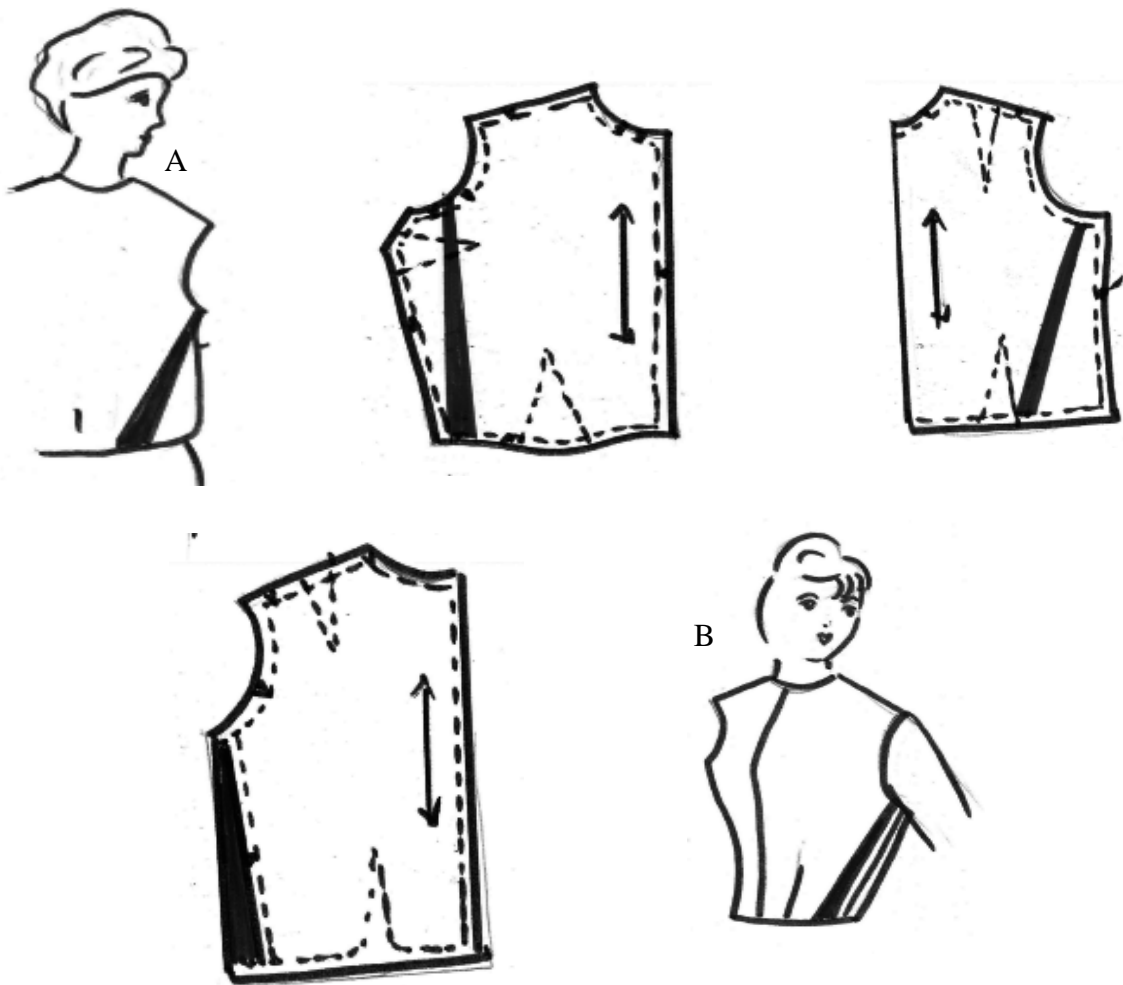
Decreasing Waist Line



**Fig. 8.21. Too Short Waistline**

**8.7.2. Increasing the waistline**

To increase the waistline or add width of the pattern at the waist. Since you have two front seam edges and two back seam edges, divide the amount you need to increase the waist line by four and add



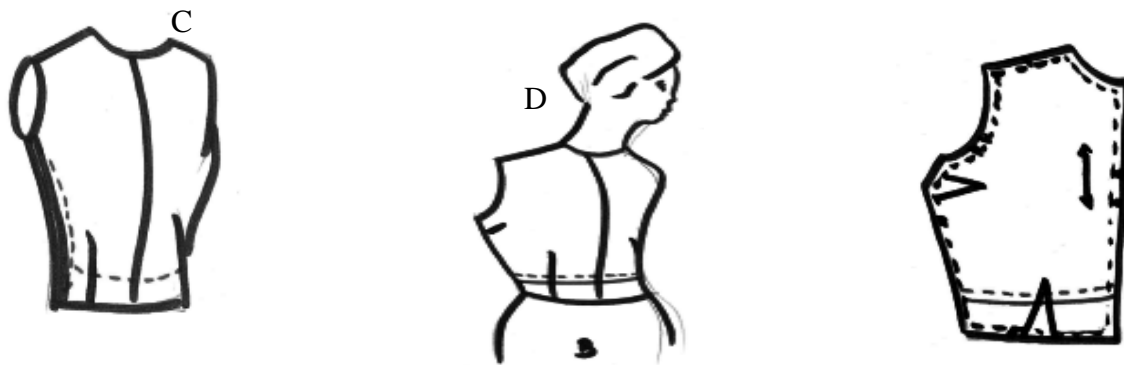
**Increasing the Waistline**

it at the side seams of the back and front waist (Fig.A). Add this amount at the waistline of the skirt as well. There are additional waistline adjustments that have to be made, depending upon your particular figure faults.

For instance, if the underarm seam of the bodices pulls toward the front, it means that the front of the figure protrudes and the increase in must be made only on the front waist (Fig.B).

To make this alteration, slash your basic pattern from the waistline lengthened, as is often the case, continue cutting from the point of dart straight across the front of the pattern and lengthen as needed, shape the dart to fit correctly (Fig.C). If the waist needs enlarging, spread the pattern at the waistline slash.

For the extremely full-busted figure slash the pattern to the shoulder and spread. Usually, with this adjustment, the shoulders have to be narrowed with a tuck from the center shoulder towards the bust (Fig.D)(Figure 8.22).

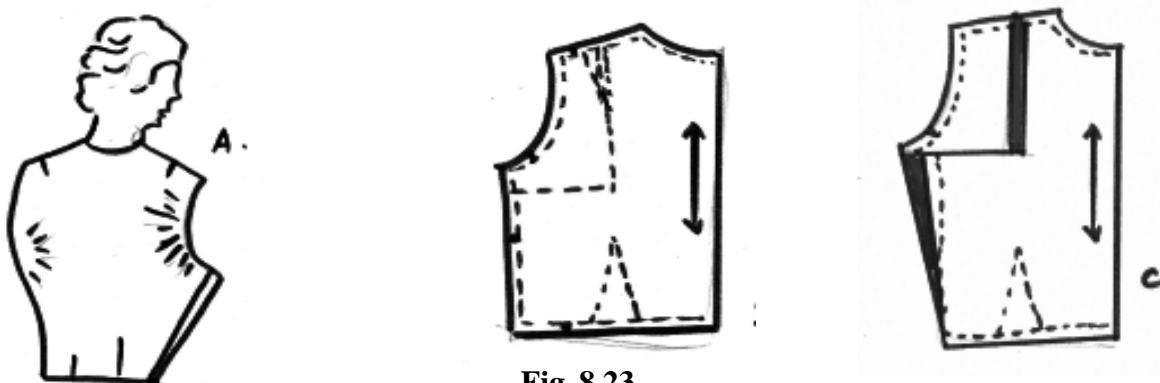


**Fig. 8.22. Too Long Waistline**

### 8.7.3. Full Back

Generally, the pattern is too small at the back, although the rest of the pattern fits properly (Fig.A). You need only to broaden the shoulders for a comfortable fit.

To make an adjustment, slash across under the armhole and up through the shoulder, moving this piece out on the shoulder to give the necessary fullness across the back (Fig.B). The back shoulder must be made broader because the figure is round shoulders. Extra fullness is needed across the shoulder blades but not at the top to ensure keeping the correct armhole and neckline (Figure 8.23).



**Fig. 8.23**

### 8.7.4. Very full bust

Usually, all the patterns are designed according to bust measurement, but when bust fullness is extreme, a pattern made by this measurement would be much too large at the neck and armhole. Therefore select a size that gives the best fit at the armholes, regardless of bust measurement. This smaller pattern will probably fit well except across the bust, where it will be too tight for your figure (Fig.A).

Make the bust size larger by slashing the pattern from waist line to armhole and from the center of the bust dart towards the point (Fig.B). By spreading the pattern here you get more fullness for the larger bust. The dart becomes larger and deeper.

If the waist line also needs to be lengthened, as is often the case, continue cutting from the point of dart straight across the front of the pattern and lengthen as needed. Shape the dart to fit correctly (Fig. C). If the waist line is also needed to the armhole, insert the amount needed at the front to correct the under arm seam (Fig.B).

If the back is full, the seam will pull towards the back. Adjust this the same way (Fig.C). If the waistline is to be increased more than two inches, it is advisable to slash the back and front pieces to make the adjustments, within the basic pattern rather than on the outside seams (Figure 8.24)

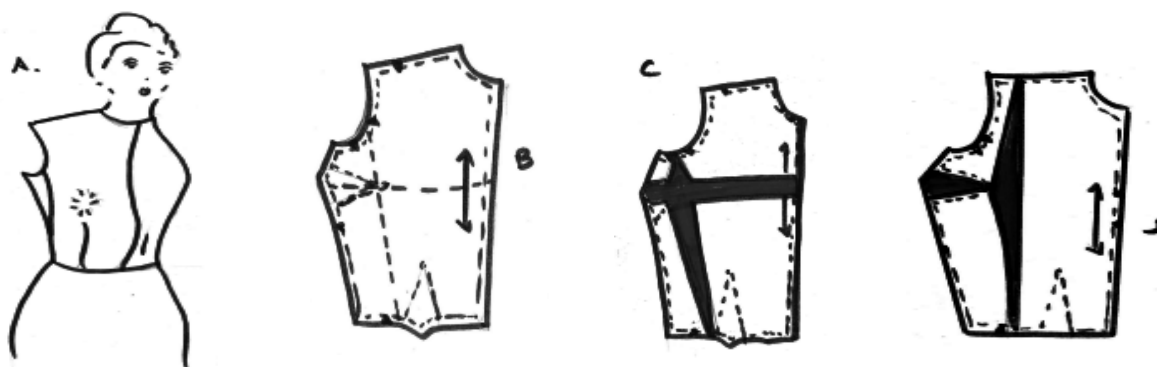


Fig. 8.24

### 8.7.5. Full bust – Small waistline

With the small waist line and full bust, the waist adjustment can also be used to give a better bust fit. The back waist line is made smaller by taking a dart at the side of the waist, from the waist line towards, the armhole (Fig.A). Make the front waist line smaller by taking a deeper waistline dart. Fit

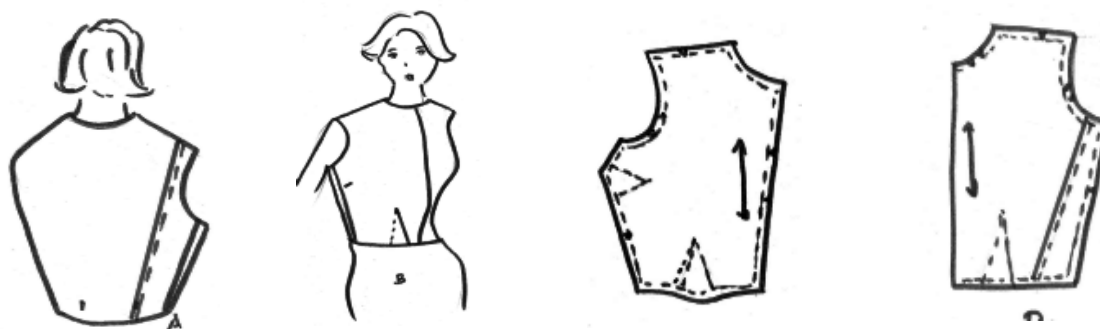


Fig. 8.25

the dart on the outside edges of the dart line (Fig.B). On the pattern mark + the front dart deeper only on the outside line of the dart, so that the bodice and skirt darts will line up (Fig.C). Adjust the back pattern (Fig.D). Never take back darts in deeper, because the back bodice will appear to bulge the figure will look round shouldered (Figure 8.25).

### 8.7.6. Fitting for the small hip

One must match the bodice and skirt darts. The darts towards the center on the front and back bodice must always flow on a continuous line. Thus the darts must be taken in or let out only on the outside line.

When the waist and hip are both smaller than the pattern, a tuck can be taken the whole length of the pattern then folded into the pattern at the same point (Fig.A and B). When only the hips are smaller and need adjusting, fit out the excess fullness at the side seam of the muslin. You can fold this same amount of the pattern before it is cut, or you can fit it out and leave it in the seam of the finished garment.

If the front or back of the skirt has a puff below the darts that can't be fitted out, the darts are too deep, giving more shape than is needed (Fig.C). (Side skirt at the fullest part of the hip, taper the darts from nothing at the side seam toward the slash to shape the skirt). Make the adjustment by adding this amount to the top of the skirt pattern to correct for this figure fault, giving a good fit at the waist (Fig.C) (Figure 8.26).

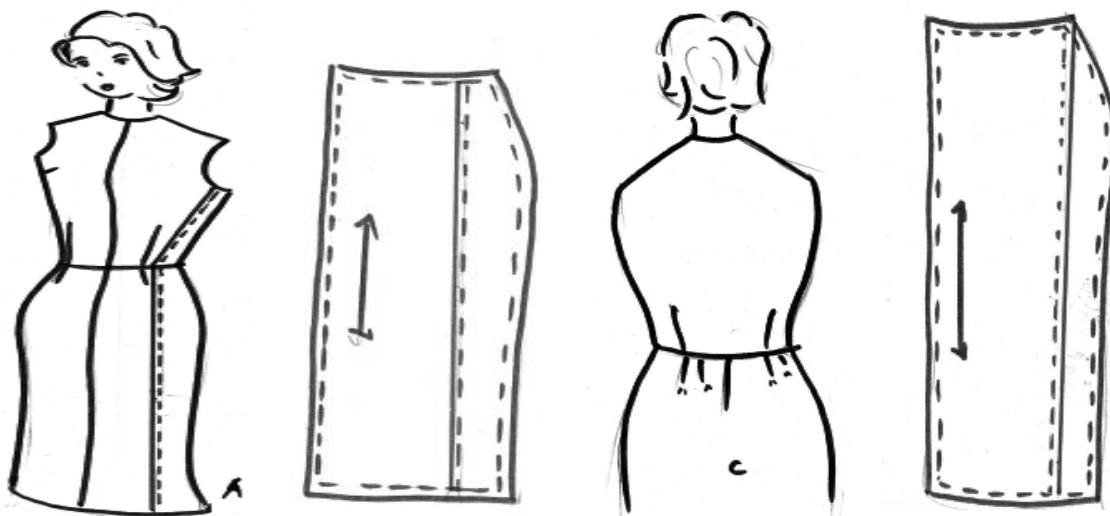


Fig. 8.26

### 8.7.7. Flat derriere

When the figure is flat in back, the amount of shaping for the full derriere, is not needed (Fig.A). To eliminate this open the back darts and make them small. Pin the excess fabric out at the side seams. sometimes with this figure, the skirt also has a tendency to sag at the back. This can be eliminated by fitting a dart across the top of the skirt under the waistline, as for the sway –back figure (Fig.B). To adjust the pattern, re-mark the back darts making them smaller on the outside line only. Fold the dart across the pattern under the waistline as you did for sway – back (Fig.C). To remove the excess fullness across the skirt, pin a tuck the length of the skirt close to the side seam (Figure 8.27).



**Fig. 8.27**

### **8.7.8. Large Pelvic Bone:**

This is almost exclusively a fault of the junior figure. The hip bone protrudes, causing a bad fit at the side seam and ward the center back. Do not make the skirt front fitting darts deeper, except when fitting for large pelvic bones. Altering bodice darts is exactly the reverse. The front darts of the bodice can be made deeper for a better fit to the bust when making the waist line smaller, but back darts are never made deeper, as this makes the figure appear to be round – shouldered (Figure 8.28).



**Fig. 8.28**

### **8.7.9.Sway-Back**

Usually with this figure fault, folds appear across the top of the skirt just below the waistline (Fig.A). Pin the fold across the top of the skirt, tapering it to nothing at either side so that it fits correctly (Fig.B). Check the grain line, making sure it runs evenly around the fullest part of the hips. Make the adjustment in your pattern at the same point(Fig.C) (Figure 8.29).

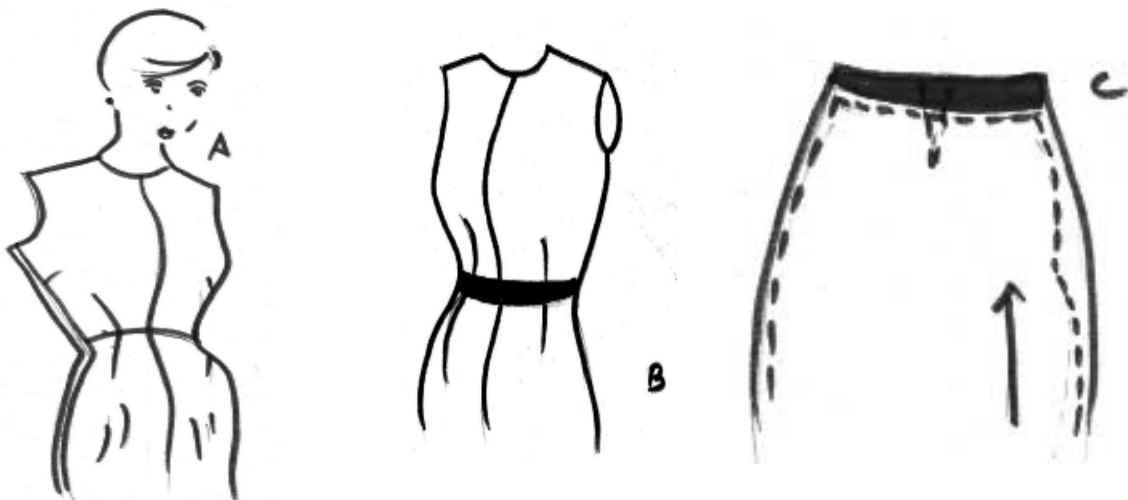


**Fig. 8.29**

### 8.7.10. High abdomen

With this fault, the skirt rides up a center front (Fig.A). To correct, open the skirt at the center-front waistline and drop it until it hangs smoothly (Fig.B). It may be necessary to add fabric here to give even more length at the waist line seam dart across the side skirt at the fullest part of the hip. Taper the dart from nothing at the side seam toward the slash to shape the skirt.

Make the same adjustment in the pattern (Fig.C) as on the basic pattern (Figure 8.30).



**Fig. 8.30**

### 8.7.11. Increasing the skirt waistline

The skirt waist size is increased by adding at the side seam of the pattern (Fig.A and B). The skirt is never slashed to adjust the waist size as is sometimes done to alter the bodice waist line (Fig.C). Increase the skirt waist size by the same amount and at the same point as the bodice waistline has increased, that is, on the front skirt piece only, on the back skirt piece only, or on both front and back pieces (Figure 8.31).

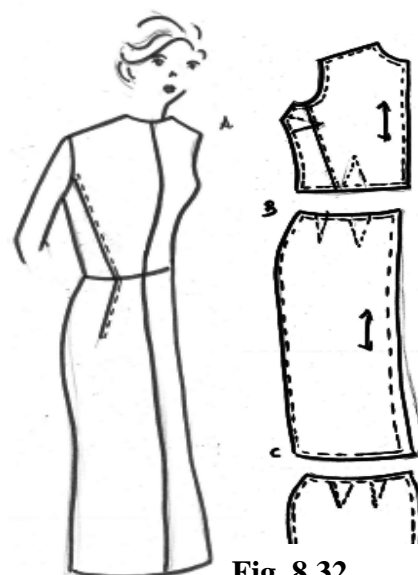


**Fig. 8.31**

### 8.7.12. Decreasing the skirt waistlines

To decrease waist size, fold a dart from the waist line toward the hip. Alter the skirt the same amount as the bodice (Fig.A and B). If the waist is very small in proportion to the hips, alter the skirt back waist by making fitting darts, slightly deeper. Adjust the darts only on the side to make them smaller by cutting out on the outside line of the dart. Remove the excess from the waist and hip size by taking the tuck along the length of the pattern. Correct the pattern in the same way.

Generally, this adjustment is needed only in the back, except when the stomach is also flat. In that case, further adjustment will be necessary (Figure 8.32).



**Fig. 8.32**

### 8.7.13. Fitting for the full hip

When the hips are wider than the pattern size, let out the seams of your muslin and, when cutting your dress, add the necessary amount at the same places. If a large amount has to be added at the hip and not at the waist, the pattern can be slashed from the hem to the waist about 4 inches from the side seam. Spread the muslin the amount needed for the correct hip size and pin a piece of fabric here to hold (Fig.A).

To adjust the pattern, add the same amount, at the side seam (Fig.B). The amount spread at the full part of the hip should be the same as at the hem line. Remove the extra flare pin, so that it fits over the hip bone. Then make it deeper so the fit is smooth. This may mean enlarging the front waistline. It is done by adding extra fabric at the waist seams (Fig.B). To adjust the pattern, re-mark the waistline darts at the correct point. If the waist size has to be increased, add the extra amount onto the outside waist seams (Fig.C) (Figure 8.33).





**Figure 8.33**

**8.7.14. Pointed elbows**

If the elbows are exceptionally pointed even though the darts are in the right place, the sleeve may be too tight and pull from the shoulder. More amount of material is required at the elbow. Therefore pin each dart a little deeper and test by bending the elbow. When it feels comfortable, measure the amount added to the dart. When adjusting the sleeve pattern, slash through the center of the dart towards the inside sleeve seam and spread each dart to the necessary amount. The darts are deeper when sewed and give more cupping at the elbow for a more comfortable sleeve. If the sleeve are lengthened or shortened, adjust the pattern at the same point as in figure (Figure 8.34).



**Fig. 8.34**

**8.7.15. Full upper arm**

The figure with a full upper arm usually needs more fullness at the top of the sleeve, but not a larger arm hole. To increase sleeve size without increasing armhole size, slash the length of the sleeve through the center, and spread the required amount when adjusting the pattern slash the length of the sleeve and spread. Take darts from the slash towards the cap of the sleeve to make it lie flat. The darts taper to nothing at the armhole and does not affect armhole size (Figure 8.35).



**Fig. 8.35**

## CONCLUSION

To conclude, one must determine the type of figure and alter the basic pattern as needed. If the figure has two problems like flat-chested and round, then alter the pattern for both type of figures. Like this we can make the muslin pattern, and make a good fitting, suitable garment for any type of figure irregularities. A clear knowledge about pattern alteration will help each designers to develop well fitted garments for all types of costumes.

## QUESTIONS

### I. Choose the correct answer

- Basic patterns are made according to the \_\_\_\_\_ measurements.  
a) Body                      b) standard                      c) size                      d) age
- It is necessary to alter the basic pattern in one or more places to insure a \_\_\_\_\_  
a) good fit                      b) comfort                      c) drape                      d) appearance
- Permanent alteration in patterns is done using \_\_\_\_\_ method.  
a) fold                      b) slash                      c) both(a) & (b)                      d) slash and spread
- When must the patterns be altered?  
a) before stitching      b) during stitching      c) during designing      d) before cutting
- Additions or extensions must be made by \_\_\_\_\_ an extension strip to the edge involved?  
a) taping                      b) sticking                      c) cutting                      d) altering
- \_\_\_\_\_ method is used to lengthen the blouse  
a) slash                      b) separate                      c) both(a) & (b)                      d) fold
- While altering the skirt pattern \_\_\_\_\_ must be straight  
a) grain line                      b) design                      c) dart                      d) none.
- To lengthen an extremely flared skirt add the necessary length at \_\_\_\_\_  
a) Hemline                      b) waist line                      c) overall                      d) both (a) & (b)
- \_\_\_\_\_ lines are preserved  
a) original grain      b) designer's                      c) both (a) & (b)                      d) dart line
- Pattern can be altered according to \_\_\_\_\_  
a) figure                      b) design                      c) age                      d) size
- The figure with a full upper arm usually needs more fullness at \_\_\_\_\_  
a) large armhole      b) bottom of the sleeve      c) top of the sleeve      d) small arm hole
- Altered patterns must have the same character as the original pattern piece \_\_\_\_\_  
a) first basic rule      b) second basic rule                      c) third basic rule                      d) fourth basic rule

13. Best method for pattern alteration \_\_\_\_\_  
 a) slash and spread      b) pivot      c) measurement      d) all the three
14. Which is the most exclusive fault of a junior figure?  
 a) large pelvic bone      b) sway back      c) high abdomen      d) pointed elbows
15. Back waistline is too long at centre back \_\_\_\_\_  
 a) square shoulders      b) sloping shoulders      c) too erect figure      d) small hip

## II Fill in the blanks

1. Patterns are made according to \_\_\_\_\_ measurements.
2. Patterns are kept in \_\_\_\_\_ and \_\_\_\_\_
3. The skirt waist size is increased by adding at the \_\_\_\_\_ of the pattern.
4. \_\_\_\_\_ are drawn to correct lines broken in making tucks across slanting or curved edges.
5. \_\_\_\_\_ lines are simple and fairly straight.

## III. Write Short answers

1. Define pattern alteration.
2. Enumerate the uses of pattern alteration.
3. Explain pattern alteration to shorten blouse.
4. List out the types of figure in which pattern can be altered.
5. Explain the method of pattern alteration.
6. List the standards for pattern alteration.
7. What are the characteristics of pattern change in widthwise?
8. What is the pattern alteration for sloping shoulders?
9. Give the importance of altering the pattern.
10. List the pattern alteration for basic fit problems.

## IV. Give brief answers

1. List the problems faced in altering the basic pattern. Explain it with suitable figures.
2. Explain the basic rules in pattern alteration.
3. How pattern can be altered for a shortened skirt and lengthened sleeve?
4. Write short note on shoulder width alteration.
5. Explain the need for pattern alteration.

6. Write the method of altering the pattern for shoulder width.
7. List the characteristics of patterns altered in lengthwise.
8. Write the method of altering the pattern
  - a) Increasing skirt waistline
  - b) Decreasing skirt waistline
9. Pattern alteration for fitting for a small hip.
10. Give the pattern alteration for round shoulders.

**V. Give detailed answers**

1. Explain the pattern alteration for any three of the following.
  - i) widening waist back    ii) to lengthen blouse
  - iii) full upper arm    iv) increasing the skirt waist line
  - v) pointed elbows.
2. Explain pattern alteration for different types of shoulders.
3. Brief pattern alteration for different types of figures.
4. Explain pattern alteration for figure irregularities (any three).
5. Illustrate the pattern alteration for
  - a) Flat chest
  - b) Full bust
6. Explain with illustration the pattern alteration for flat derriere, large pelvic bone and sway back.

**Keys**

**I Choose the corect answers**

- 1) b,    2)a,    3) c,    4) d,    5)a,    6) b,    7) a,    8) a,    9) c,    10)a,    11)c,  
 12) c,    13) a, 14) a,    15) c.

**II Fill in the blanks**

- 1) standard    2) proportion and balance    3) side seam    4) Transitional    5) Designers

## 9. BELTS AND BOWS

### INTRODUCTION

Belts are used for finishing waists of dresses and are often worn to hide the waist joint of bodice and skirt. The style of belt must be in keeping with the design of the dress. Contrasting or suitable blending colours can be used effectively.

Belts made of material from the garment serve both utility and decorative purposes. They may be made soft or with stiffening, wide or narrow plain or intricate, depending upon the garment and the trend of fashion. Stiffening applied as a facing or interfacing keeps the belts in shape and gives it a tailored effect. Muslin, belting cross grain ribbon or leather may be used. The belt is usually fastened with a covered buckle or a novelty buckle. Faced, interfaced, tie belts and skirt bands are cut on length wise grain, while sash belts are on the bias.

#### 9.1. How to check belt length:

To start with, the belts length must be checked and noted. It must be about 7" longer than is required to reach around the body. Many persons make a belt 7" longer than their waist measurement and find to their disappointment that the belt is small. For this reason, the pattern to the width must be checked on the body before hand.

#### 9.2. Types of belts:

The detachable waist belts are of two kinds :

1. Soft or unstiffened
2. Stiffened to give a firmer finish.

##### 9.2.1. Soft belt or tie

A length of tape is tacked to the right side of the pointed end, but clear of the stitching in order to pull the belt inside out after it is machined. The tape must be tacked before the two sides of the belt are fixed in position. Right side facing (Fig. A). Machine round the pointed end and one or both long sides are necessary. Leave the square short end unstitched for turning through. Trim even the belts. Snip of the pointed edge fairly near to the machine to avoid bulk when turned through. Pull end of tape and work the belt inside out (Fig. B). Remove tacks of tape, work out seam edges, especially the point, tack these in position and press wrong side. Turn in the short square edges to face each other and slip stitch them together (Fig.C). This belt is simple to construct, at the same time it can be made of the garment fabric itself (Figure 9.1).

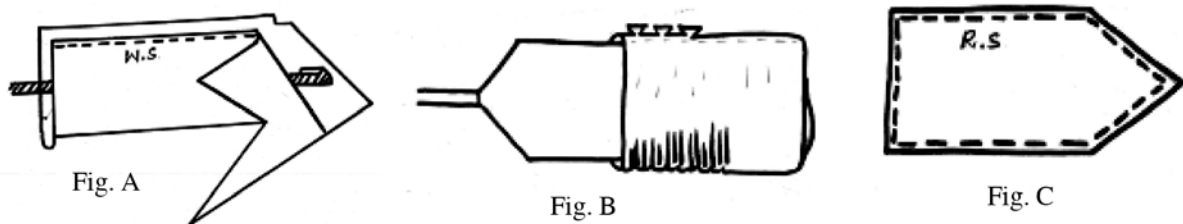


Fig. 9.1

### 9.2.2. Stiffened belt:

The stiffened belts are made using a stiffening material, in order to hold the belt in place. One must be careful while choosing stiffening material according to the kind of material used for the belt.

For construction, cut the stiffening to the exact size of the pattern without turnings i.e. exact size of finished belt.

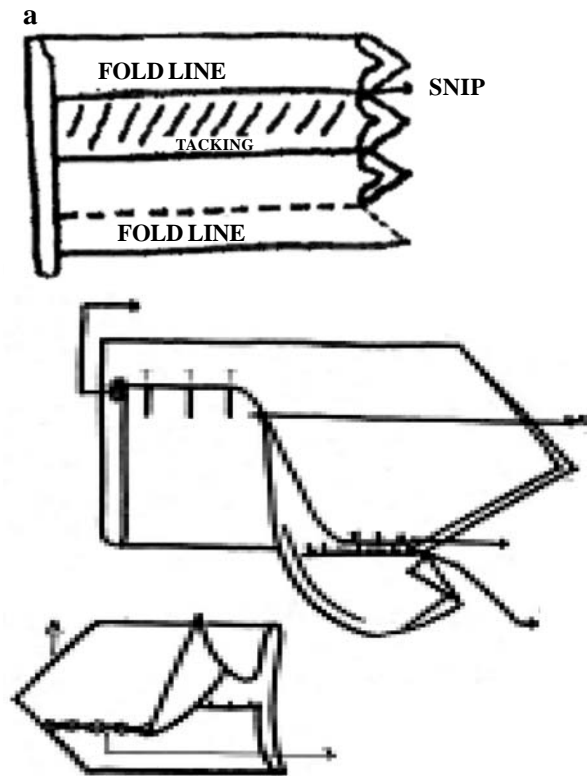


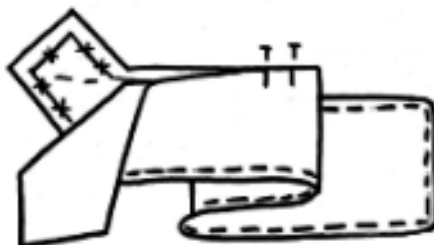
Fig. 9.2

Then lay the stay or stiffening piece to the center fitting lines of the belt on the wrong side. Tack into position and ship the turnings of the pointed end as shown in Fig. For flatness when turned, fold these turnings on the wrong side of the fitting lines. Pin and tack both these and the turnings of the short square end into position. Turn one long side, over on to the stiffening material keeping it quite flat, pin it into position, then catch-stitch the raw edge to the stay only. Fold over the remaining long side of the belt turning under the raw edge. Pin and tack this in place, and slip-hem the fold into position. Machine stitch in even rows on the right side of desired or leave quite plain. Attach a buckle to the square end if required. These belts give an enriched look. They also can be made with the garment fabric itself (Figure 9.2).

### 9.2.3. Shaped on wide belts

These belts are shaped to add beauty. To construct this, first cut the interfacing of pre-shrunk canvas or pillow. Use a weight of interfacing suitable for the fabric. Trim off all seam allowance on interfacing. Pin to the outer belt fabric. Pin, turn and baste the fabric edges over the interfacing,

clipping the curved edges if belt is shaped. Pin the turning to the belt, turning in the edges, clipping where necessary. Baste, slip and stitch the folded edges of the lining to the belt. The belt may be edge- stitched from the right side as desired (Figure 9.3).



**Fig. 9.3**

**9.2.4. The interfaced belt:**

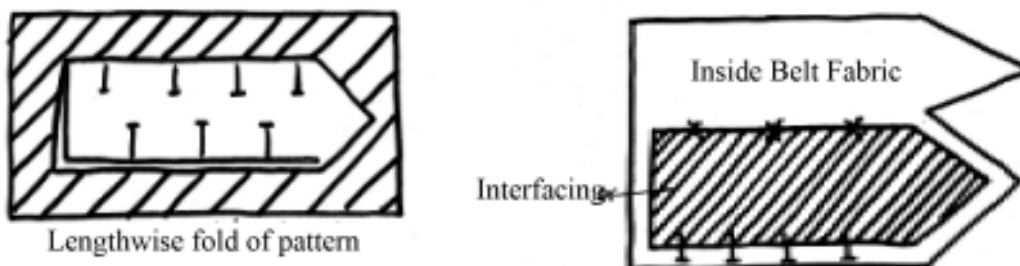
The interfaced belt is the softest belt used by those persons who require comfort. It has the disadvantage of folding over, when worn, and might become rope-like. It is not the most desirable belt from the fashion point of view as many prefer stiff belts. The stiff belt is easy to make. One must be careful in selection in the case of washable belts.

To construct this, first fold the belt pattern in half -length wise and cut the interfacing fabric at the fold.

Then pin the interfacing to the wrong side of the belt, with the cut edges even, as shown in (Fig.2). Catch stitch the long edge of interfacing to the center line of the belt.

Then, fold belt in half- length wise, right sides together, and stitch the pointed end along the edge of the belt. Trim corners and turn belt right - side out.

To finish, turn under the seam allowance. Pin the opening edges together with the end of belt. Baste finished edges of belt and Press it. It can be top-stitched near the long edges if desired. Attach buckles, and finish (Figure 9.4).



**Fig. 9.4**

**9.2.5. The belt with belting as backing**

This belt is professional - looking because it resembles closely the belt with a leather backing used on purchased garments. The stiff belting keeps it from folding over and becoming rope-like, and so this belt construction is the only desirable one. These directions differ from those usually described in the instruction sheet, and therefore additional notations are required. Pre-strink the belting and cross grain ribbon to be used if the belt will be washed.

1. For construction first carefully shape one end of the belting as desired. Cut off a piece of belting to the necessary length to reach around the body with an overlap of about 7 inches.
2. Then cut a strip of matching fabric (lengthwise) one inch wider and 1" longer than the belting.
3. Hold the belt in a curved position as it will be on the body when you wear it. Lap one edge of the belt fabric  $\frac{1}{2}$  inch over the belting and baste in place firmly.
4. Holding the belt in a curved position, wrap the fabric around the belting. Keep it firm and evenly tight so that the cross wise threads are not pulled off-grain. Pin it in place over the belting and baste the remaining edge in place.
5. From the outside, machine-stitch the edges of the belt, using slightly longer stitch than used for the seams of the garment. Personal preferences will determine how close to the edge these stitches must be. Don't make them closer to the edge. These stitches must be at least closer than  $\frac{1}{8}$  inch, far-to- far stitching may not hold the belting. Usually  $\frac{1}{4}$ " is preferred. To finish the raw edges on the underside, pin cross grain ribbon in place with hand stitches about  $\frac{1}{4}$  inch apart.

This belt is also made wider as waist bands, for many of young girls skirts (Figure 9.5).

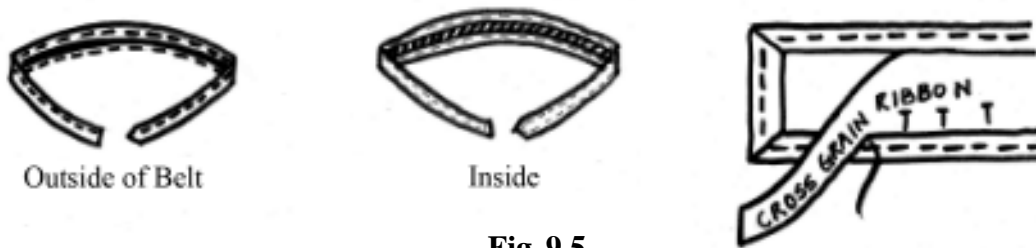


Fig. 9.5

#### 9.2.6. The contour belt:

The contour belt is shaped to the body so that it will rest quite naturally at the waist line, dipping down at the back. It is usually slightly wider at the back. If it is a wider belt, the contours show up more than on a narrow belt, where the contours are hardly check when worn. This belt takes more time to make than the straight belt with belting as a backing.

It is constructed by cutting an interfacing, facing and the stiff, in a cross grain to hold the belt properly in position. The belt is inter - turned and finished in the same way as interfaced belts (Figure 9.6).

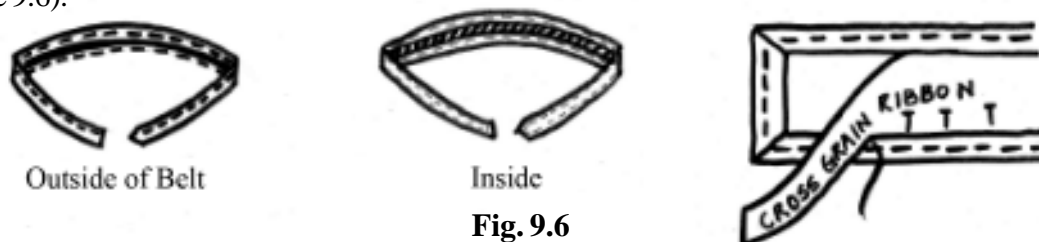
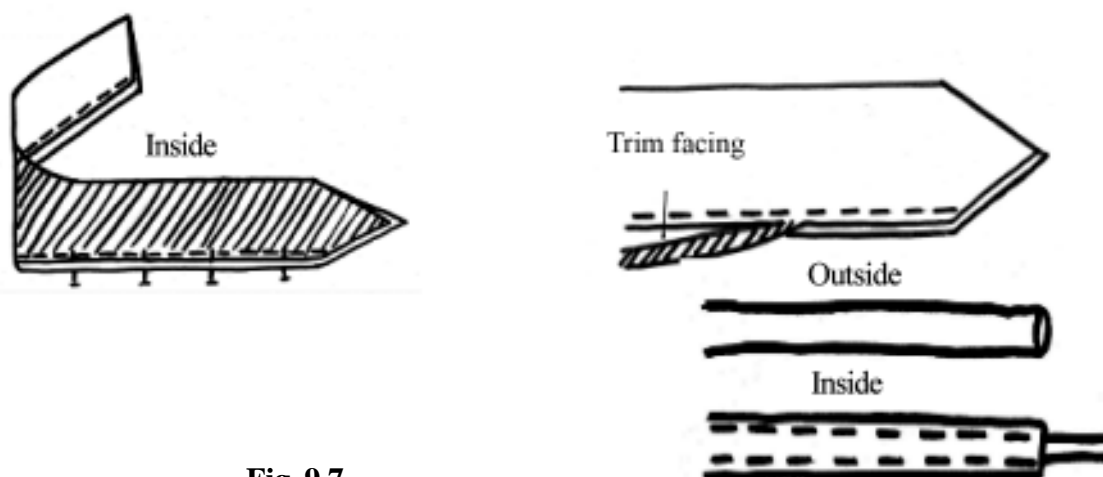


Fig. 9.6

#### 9.2.7. The inner belt

This belt is usually made with the inner material at the waistline for extra stiffness. This is cut in a cross grain ribbon, and finished at the inner part of waist band which hold the skirt. This belt enriches the natural shape of the human figure (Figure 9.7).





**Fig. 9.7**

To conclude, we find that belts play an important role in garments. Every finish to a belt is a baste and press, after which buckle and eyelets are attached. Belts are of different types and each one is good in its own way. They could be changed according to the pattern.

### **9.3. BOWS**

Bows are fashionable decoration used on garments. These bows add beauty and enrichment to the finished garments. They are usually added in garments of children and women. Bows are made out of fabric, and used with buttons at times.

#### **9.3.1. Types of Bows**

**9.3.1.1. Simple bows:** A simple bow is shaped as a butterfly, or sometimes made with longer flowery bows. In this case, the wider the bow the longer is the length required for tying. Normally, the centre of the bow is narrower than the ends. Cut the bias fabric into two. A wide finished width is required with turnings. Fold in half, the other way and shape it so that it is slightly narrower at the fold line. With the right sides together, stitch the ends and the long side leaving 5 cms (2 inches) unstitched at the center. Trim turning to 0.6cms and cut off corners. Turn through to right side, press seam line first. Towards the fold, pressing with the straight grain line, Slip-stitch the opening.

Fold into half and mark centre with a pin. Make a loop on either sides. Take right loop in the right hand, left loop in the left hand and bend loops forward. Take right loop over left loop and bring it out between the loop and the pin marking i.e central position. Pull tightly until both the loops are equal in size. This is the most beautiful type of bow.

**9.3.1.2. Gathered bows :** Simple bows of lace, embroidery, or self fabric make a smart trimming for plain dress. Shape the bow as desired and hem the edges, or face with self-fabric. Run 3 rows of gathering stitches through the center and draw up tight fashion threads securely. When the fabric is soft and needs a little stiffening, use a layer of tartan or organdy inside faced bow.

**9.3.1.3. Ribbon bow:** Bows are made of ribbon or fabric tubing to close an opening at the neck and waist, or for simple decoration. To make a bow, pin the ribbon to place at each corner in consecutive steps as shown. Tack the position with invisible stitches. If velvet or satin ribbon is used, inter fold at each corner so that the fold on the underside of the ribbon will not be exposed.

These types of bows are easy to make and at the same time beautiful.

## CONCLUSION

Belts and bows add interest and variation to the garment. Children enjoy belts and bows. This varies depending upon age, sex and nationality. Generally, men prefer stiff and broad belts where as women and children prefer soft and silky belts.

## QUESTIONS

### I. Choose the correct answers

- Which belt is cut on bias  
a) tie                      b) faced                      c) skirt                      d) sash
- \_\_\_\_\_ is the softest belt  
a) shaped                      b) tid                      c) stiffened                      d) interfaced
- Which belt has professional look?  
a) belt with belting      b) contour belt                      c) interfaced belt                      d) stiffened belt
- A belt should be about \_\_\_\_\_ inch longer than required  
a) 7"                      b) 9"                      c) 5"                      d) 8"
- Which belt takes more time for construction.  
a) simple                      b) shaped                      c) contour                      d) interfaced

### II. Fill in the blanks

- \_\_\_\_\_ are used as buttons sometimes
- \_\_\_\_\_ belt enriches the natural shape of the human figure.
- \_\_\_\_\_ is also made wider as waist band for young womens skirts.
- \_\_\_\_\_ belt is not the most desirable belt from fashion point of view.
- \_\_\_\_\_ colours are effectively used in belts.

### III. Write short answers

- List the types of belts.
- What are bows?
- State the purpose of using belts?
- How will you check the length of the belt?
- What is a gathered bow?

### IV. Give brief answers

- Explain stiffened belt with a neat illustration.
- Explain the belt with belting as backing.

3. Explain the method of construction of interfaced belts.

**V. Give detailed answers**

1. Explain the types of belts (any three) with illustration.

2. What are bows? Explain the types.

**Answers**

**I. Choose the correct answers**

1) d, 2) d, 3) a, 4) a, 5) c

**II. Fill in the blanks**

1) Bows      2) Inner      3) Belt with belting      4) Interfaced      5) Contrasting

## 10. GARMENT ENRICHMENT

Irrespective of age, sex and nationality every individual wants to look as his best, which is rightly catered by garments. A plain piece of fabric will make one dull, therefore every garment is enriched with some decoration and trimmings. They are like two sides of a coin, which can be used separately or together. They used separately or together. They are a must for any garment, to be well made and finished. On the other hand these enrich the garment thus cutting a pattern, is not enough to finish a garment but one must consider the need for decoration and select proper trimmings, simple to suit the pattern, then only the construction is taken into account.

### 10.1. Decoration

Decoration means enrichment of garments. They can be done on the surface of the garment to enhance the look or made to sew as a part of the garment. Decoration vary depending upon garment, person using and figure types.

### 10.2. Types of decoration

**10.2.1. Structural decoration:** Structural decorations are decorations introduced in the structure of the garment. This begins with good structure or cut, strengthened and controlled by fit and workmanship. This also adds fullness to the garments.

**10.2.2. Surface or Applied decoration:** Applied decoration consists of self-material as well as contrasting materials and colours worked up ingeniously and applied artistically but not added as a 'stuck-on-trim'.

### 10.3. Different types of structural decorations:

**10.3.1. Darts:** Dart is a fold of fabric stitched from a specified width to nothing at one or both ends. These are used to make flat fabric fit on curved lines, according the body shape. They are usually biangular. Darts are made in different parts of the garment, like neck line, shoulder etc (Figure 10.1).



Fig. 10.1 Darts introduced at neck line for dec

**10.3.2. Gatherings:** Gathering means to draw together into a mass. Gathering is one form of introducing fullness. These are made used, when large material is to set in a small art of the garment. When several rows of evenly spaced gathers are used they are known as "Shirring". Gathers may be used for neatness, loose fitting, comfort, free movement, and gracefulness (Figure 10.2).



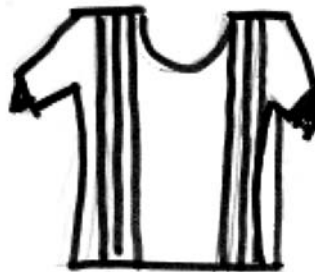
Fig.10.2 Gathers introduced at the waist line

**10.3.3. Pleats:** Pleats are folded mass of material that provide fullness, when evenly spaced and perpendicular to the floor, thus achieving the straight silhouette. There are various types of pleats as, side, box, double box, inverted, kick, pinch, straight, cartridge and sunray pleats. (Figure 10.3).



**Fig.10.3. Pleats introduced at the waist line**

**10.3.4. Tucks:** Tucks are similar to pleats, but are sewn through out their length. Hence fullness is available only below the tuck. There are a number of tucks as cross tucks, shell tucks, curved and scalloped (Figure 10.4).



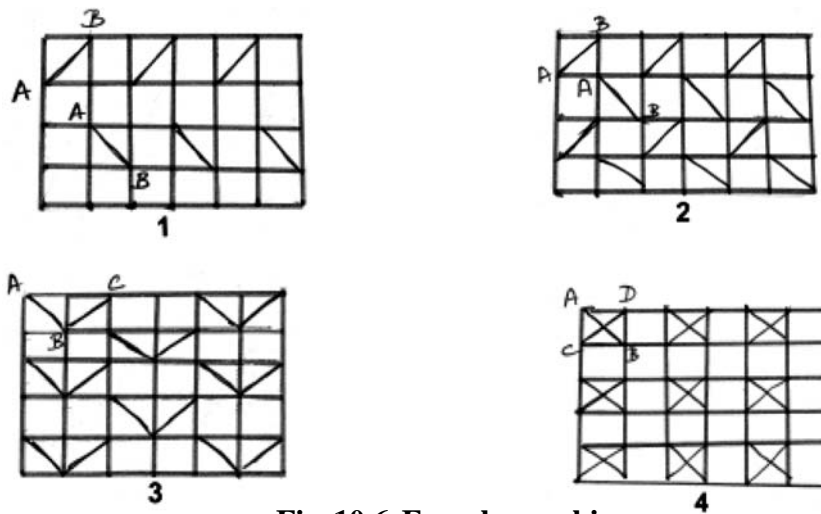
**Fig.10.4. Pin tucks introduced at the shoulder line**

**10.3.5. Smocking:** This is a decorative work particularly valued because of its beauty on children's garments, and other smocked jackets. It is a kind of decorative stitch done by pulling certain amount of material to gather. They vary their stitches, as honey comb, hooking bone, double, etc (Figure 10.5).



**Figure 10.5 Smocking introduced at the yoke**

French smocking is outstanding type, where this gathers a large amount of material. There are 4 types. First draw the pattern on the material as shown in the figure in  $\frac{1}{2}$ " or 1" squares. Then join the points A, B, in Fig. 1 and 2. ABC, in fig.3, and ABCD in fig.4, then pull, make a knot and go on to the next square. There the thread must be left loose, for the next square and the stitch must be continued. This adds beauty and fullness. (Figure 10.6).



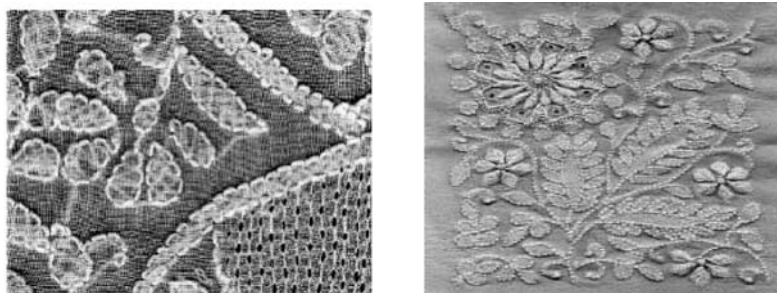
**Fig. 10.6. French smocking**

#### 10.4. Different types of applied decorations

**10.4.1. Embroidery:** Embroidery is one of many good methods of applied decoration. But it needs good skill, time and artistic talent. Embroidery may be done by machine or hand. This aspect is already discussed in XI text.

**10.4.2. Chikankari Embroidery :** Chikankari embroidery also known as shadow work, is the most common and popular form of embroidery that is typically designed with predominant white threads. It is an intricate needlework, which represents the art form of the city of Lucknow. Chikankari is a light and very well suited to hot climatic conditions. It combines comfort and aesthetic value. We offer our valued clients with customized chikankari designs as per their preferences on varied fabrics.

Lucknow, in Uttar Pradesh, is the center of chikan embroidery, renowned for its timeless grace and its gossamer delicacy, a skill more than 200 years old. A study of the origin of chikan reveals that this form of embroidery had come to India from Persia with Noor Jehan, the queen of the Mughal emperor Jehangir. The embroidery found a place in the prestigious homes in Europe, specimens of which are still available. The design to be embroidered is printed on the fabric with wooden blocks or brass blocks using fugitive colours. The embroidery has a repertoire of about 40 stitches of which only 30 are still being used. Among these the most commonly used are running stitch, herringbone and back stitch. These can be broadly divided into 3 heads- flat, raised and open trellis like jaali work. The patterns are mostly inspired from Mughal culture (Figure 10.7).



**Fig.10.7**

### 10.4.3. Coin Work Embroidery

Coin work embroideries a delightful embellishment on different fabrics or attire. The fragile coins have detailed raised decorative surface for an attractive look. Every coin is delicately embroidered into the base using thread, ribbon or wire. Our collection highlights perfect blend of traditional Indian heritage and contemporary artwork. We have expertise in custom design coin work to suit the taste of our discerning clients.



**Fig. 10.8**

Coin embellishment gives a metallic look to the fabric and gives a bohemian look unless combined with some beads or other material. It seems to be originated among Kuchi tribes ranging over Northern Afghanistan and Northern Pakistan. They incorporated coins in the embroidery from an ethnological perspective along with plastic, pearl and metal buttons and various tokens of particular interest. The coins were gradually added reflecting the wearer's wealth and trading activities. Mostly, string of metal beads threaded on cords are disposed in a geometric ,symmetrical pattern that complements the lines of construction of the dress (Figure 10.8).

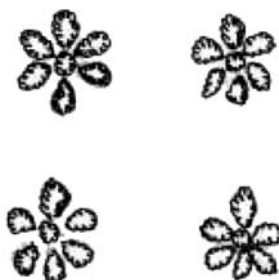
### 10.4.4. Dori Embroidery

Dori embroidery is essentially a cord or a strong thread .Different colors of cords are used for the embellishment of the fabric using couching stitch mainly and some stitches of zardozi .It is usually combined with sequins, pearls , gota to create a mesmerizing effect.

The cord used in Doriwork has a rich metallic color that brings definition to the design. The thread is used to outline the motif on the fabric; when backstitched the clean line lifts the element of the fabric and creates a sense of dimension giving a lacy and openwork effect on the fabric. Matching colours of the cord can be used to make couching of the cord invisible or different colors can be used to create interesting contrasts. We can also use gold and silver cords to create a mesmerizing metallic effect to the embroidery.

The traditional Gotakari is a marvel designer's choice. It can be crafted in a floral pattern spread all over the attire or having dual work border. It is a unique decorative lace, which is mostly available with fine silver and golden lines. Our 100% customizable service offers our customers the choice to tailored Gotakari on any fabric according to their specifications.

The art of gotakari is very similar to the appliqué embroidery. It involves placing woven fabric either gold or silver onto the other fabric to create different surface textures. Mostly , it is used to fill up the petals of a flower or leaves. The appliqué is fixed with outlining of chain stitch or dori work to give it a dimensional effect. Sometimes, a border of gota is used as edging which is called Kinari . it is the frilled or tasseled border for decoration (Figure 10.9).

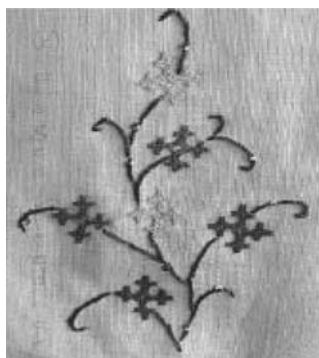


**Fig. 10.9**

#### 10.4.5. Kutch Work Embroidery

Known as 'Sindhi stitch' in earlier days, Kutch Embroidery is used to add gaiety to any fabric. Its long stitches and embossed designs form an all-over design covering the entire surface. These designs are prepared by fixing small round-shaped mirrors to the material with the help of the buttonhole stitch, the outline being sketched by hand. The entire kutch embroidery designs are made with cross-stitches. We offer a complete outfit tailored to client's specific style and needs.

This is the most exquisite and high quality representation of tribal embroidery from the kutch area of Gujarat. The bride brings to her husband's house a wealth of richly embroidered textiles carefully worked by herself and the women of her family in addition to jewelry and utensils. Each village in Kutch have a distinct style of embroidery and design. This is a very versatile embroidery involving a plenty of stitches to beautify the product like buttonhole , stem, chain, satin, herringbone, open chain stitch, interlacing stitch , Roman stitch, darning stitch and running stitch. The colours used are bright and vibrant like red, coral, orange, neon green ,indigo, turquoise , pink and purple. The motifs vary from floral, dancing human figures, peacocks to geometrical (Figure 10.10).



**Figure 10.10**

#### 10.4.6. Zardozi Embroidery

Zardozi embroidery is imperial metal embroidery. It is done after stretching the fabric on a wooden frame and individually the zardozi element is incorporated into the pattern by being picked up by a needle, which is then pushed into the fabric. Zardozi is rich embroidery, which is intricately woven in golden and silver. It can also be studded with pearls and precious stones to enhance the exquisiteness of rich and glowing fabrics like silk, velvet and brocade. We also welcome ideas and drawings from clients to deliver them with customized designs.

Zardozi embroidery is beautiful metal embroidery which once used to embellish the attire of the Kings and royals in India. Zardozi has been in existence in India from the time of Rig Veda . There are numerous instances mentioning the use of Zari embroidery as ornamentation on the attire of Gods. It was done with pure silver wires and gold leaves in olden days. The word Zardozi comes from Persia where Zar means gold and Dozi means embroidery. The embroidery is done on the fabric, which is stretched on a wooden frame. The elements used in embroidery are salma (gold wire), sitaras (metal stars), sequins, glass beads, dabka (springed gold wire) and kasab(wire). The needle is used to pull out each zardozi element and then, it is integrated into the basic design by pushing the needle into the fabric. The fabrics used are silk, satin, velvet etc (Figure 10.11)



### 10.4.7. Thread Work Embroidery

Thread embroidery is the embellishment of wide range of materials achieved with a variety of types of thread, for example; cotton, silk, wool, gold and silver wires. The work can be made on a frame or in the hand , the choice depends on several factors. There are many kinds of stitches involved.

There are two kinds of threadwork embroidery, surface embroidery and counted thread embroidery. In surface embroidery, the pattern is worked using decorative stitches and laid threads on top of the foundation fabric rather than through the fabric. In counted thread embroidery, the fabric threads are counted by the embroiderer's before inserting the needle into the fabric. Usually, an even weave fabric is used for this kind of embroidery. The various kinds of embroidery in thread are Kantha, Kashida, kasuti, Gara , Phulkari and Kutch work.. All kind of stitches are used here like chain, satin, open chain stitch, long and short, French , interlacing, herringbone ,running, stem and back stitch etc (Figure 10.12).

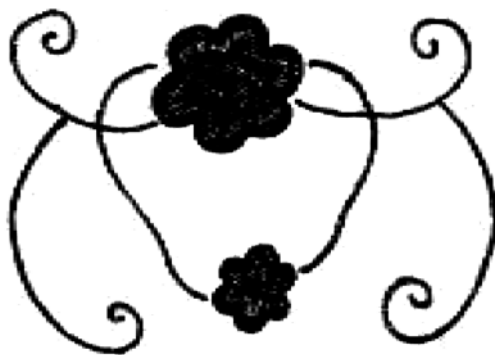


Fig. 10.12

### 10.4.8. Ribbon Work Embroidery

Silk ribbon embroidery is a romantic old art that uses ribbon, embroidery floss and perle cotton to work beautiful motifs and decorative stitches. It is either enjoyed in its pure form and can be combined with Brazilian embroidery, cross stitch, crazy quilting and Hardanger among others.

Silk ribbon embroidery is a delicate Victorian art of embroidery. There is an antique quality to this form of embroidery. Though, it looks very complicated but it is very easy and fun to do. It is mainly done by hand on garments, accessories and home furnishings. There are many different embroidery stitches used in this art , though the popular ones are ribbon stitch, lazy daisy stitch ,straight stitch , stem stitch and French knot. These can be used alone or in combinations to create large array of floral motifs and stitch patterns. The ribbon stitch uses ribbon only, but the other stitches can also be used with ribbon or thread namely sequins, pearls and stones to make rich, lively looking embellishments for garments, quilts, accessories and home furnishings. Some other stitches that are used are, feather stitch, fly stitch, split stitch and fly stitch fern (Figure 10.13).

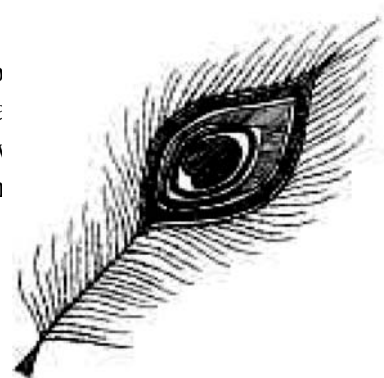


Fig. 10.13

#### 10.4.9. Stone Work Embroidery

We offer a beautiful stone work in countless patterns on various fabrics. Our plethora of designs are exclusively made while keeping in mind the latest trends prevalent in the market. We have a unique collection of stones including precious and semi-precious stones in a variety of shapes, sizes and finishes. Designed to suit the distinct taste of fashion conscious customers, our creations are available in vibrant and bold colors. We also offer customization of art work to meet the requirements of global customers.

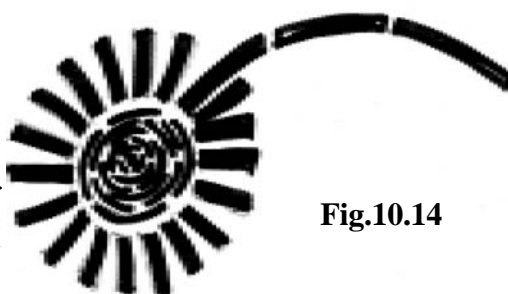


Fig.10.14

Stone work is really used to highlight embroidery. The current trend is to use crystals and semiprecious stones. Stones can be used alone as a centerpiece or in formation of lines and other various ways. They can be incorporated in any kind of embroidery to highlight it. The colored stones give an ostentatious look. Stones give an extra sense of physical realism to the embroidery. This embroidery is little on the expensive side. There are cheaper versions of stones as well available (Figure 10.14).

#### 10.4.10. Sequin Work Embroidery

Sequins are disk shaped beads used for decorative purposes and are available in a wide variety of colors and geometrical shapes. It is a kind of an embroidery work done in apparel and other handicrafts to look attractive and rich. Sequins may be stitched flat to the fabric, so that they do not move, and are less likely to fall off; or they may be stitched at only one point, so that they dangle and move easily, to catch more light. We offer a spectrum of brilliant sequinwork to our customers as per their choice.



Fig.10.15



Although coins are still used as sequins in some cultures, modern sequins tend to be made of plastic. They may also be referred to as spangles, paillettes or diamantes. They may be stitched flat to the fabric so that they do not move and, are less likely to fall off. Or they may be stitched at only one point, so that they dangle and move easily to catch more light. Some sequins are made with facets to increase their reflective ability. Sequins got their name from the Arabic Sikka meaning a coin or disc. The custom of stitching sequins and similar coins to women's clothing, particularly headdresses, face

veils and over the bosom and hips, originally arose as a way to display the family's wealth. It was this ancient wisdom that led to the use of sequined fabric and trims in modern fashion, and expanded the definition of sequin beyond coins to include this particular type of decoration (Figure 10.15).

#### 10.4.11. Bead Work

Bead work is one of the most oldest method of surface enrichment which has been done till date. Beads are small or big elements with holes in the center. Thread can be passed through the hole and fixed to the fabric. Beads are available in different sizes, colour and shapes. They can be made of different materials like plastics, metals and wood. (Figure 10.16)

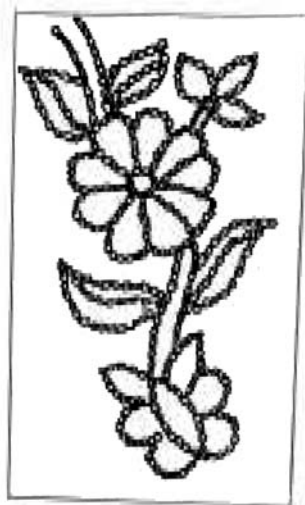


Fig.10.16

**10.4.12. Applique:** It is a technique of applying one fabric to another in a decorative manner. It is a form of embroidery work mostly consisting of motif single in number.

- Applique by hand is done by cutting the edges of the design and stitching it to the fabric using satin stitch, slip stitch, buttonhole stitch, or running stitch.
- Applique by machine is done by cutting the edges of the design and stitching it to the garment fabric using machine stitch or zigzag stitch of satin stitch.
- Quilt top applique is done by using sponge between the actual piece and the appliqué piece. The sponge is taken without seams and is attached using machine or hand stitches.
- Shadow effect appliqué is done by using a bright coloured material as the basic material over which the appliqué piece is stitched. Over this a semi transparent material is stitched.
- Freehand appliqué is the one readily available in shops which when ironed on the wrong side the applique will get adhered to the fabric (Figure 10.17).



Fig.10.17

**10.4.13. Quilting:** It is the art of stitching two or more thickness of fabric together in some planned design to provide warmth decoration or an effect of bulk. Formerly, done by hand, now it can be done by machine. Many varied effect can be produced by changing the type of stitching, the weight of padding, the fabric on which the work is done.

- Patch work quite is done by introduce patch work at the top layer alone.
- Applique work quilting has appliqué design on the top layer.
- Whole cloth quilt has the top layer quilted fully (Figure 10.18).



**Fig.10.18**

**10.4.14. Mirror work:** **Mirror work** is the art of stitching mirrors on to the fabric in a variety of designs. Mirrors of different shapes Square, Diamond, Round etc and sizes are used for Mirror work. Mirror work can be done on any fabric in sarees, blouse pieces, skirts etc. After fixing the mirror you can **stitch beads** around to make it more attractive. Sequence is a plastic silver coated material available in different shapes and size. This is also used instead of mirrors (Figure 10.19).



**Fig. 10.19**

**10.4.15. Crochet:** This is a kind of interlacing done with a crochet hook – made of steel, plastic or wood. For fine work needles vary. There are many kinds of knot. Which produce different effects. After finishing damp, pin and iron the article. To finish cut 4" away from the last loop. Thread it to needle and give a neat finish.

**10.4.16. Bias Bind:** If the edge to be bound is much curved as for instance, a neck edge, run a fine gathering thread round it to prevent stitching. Run it to the right side, then turn and finish it, cut the strip double, for bound effect of needed.

**10.4.17. Bias tubing:** It's the most versatile trimmings. It is usually of 1" wide, folding in half with wrong side out and stitch through the center of the folded bias strip. The seam will be as wide as finished tubing. Use small stitch, then turn, if needed insert bodkin and do hand sewing. It is used to finish necks, and buttons.

**10.4.18. Pippings:** these are usually applied to seam or round ends, on collars, cuffs, yokes. Cut a self or contrast bias strip ¾" wide. Join it. Place the raw edge on the right side machine stitch. Turn half way back and machine. Press after finished (Figure 10.20).



**Figure 10.20**

**10.4.19. Lace:** Lace is the form of medallions, should be tacked into place on the right side of the materials, the material behind must be cut leaving a small turning to be loop stitched, to prevent fraying. This got in many colours, shapes and size, thus a suitable one could be purchased or it can be even

done at homes, using a chrote needle. Lace making is one of women's hobbies, thus homemade ones, vary to own slaste and stand unique.

**10.5. Trimming:** Trimmings are edge finishes. They are different types of trimming. It can be classified as:-

- **Decorative trimming:** Decorative trimmings are edge line decoration, which emphasis only on beauty, like lace, or fance button, placed just for beauty. In case this is not handled properly, it appears funny. It has no functional importance.
- **Constructive trimming:** Constructive trimmings are finishes on the construct positive lines, mainly to emphasis the curves, and other body shaping lines.

Both types are added to finished garments, but he difference lies in the placements of the trimmings.

### 10.5.1. Different types of trimmings:

**10.5.1.1. Embroidered edgings:** These can be brough by the yard either gathered or ungathered. In case of plan ones, you can gather it, but buy 1½ times more than the trim. This sewed flat on the edge. Mainly in collars, cuffs, or hems without gathers (Figure 10.21).



Fig. 10.21

**10.5.1.2. Rick-Rack:** This is a strip of curved inter woven material, used inserted in pleats or lapped seams. Apart from other edge. It is easy to launder. It is sewed on flat material. In case of edges, it is stitched at center on wrong side (Figure 10.22).



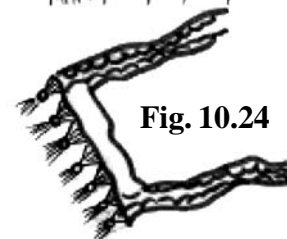
Fig. 10.22

**10.5.1.3. Fringe:** This is made by the wrap or weft yarn on a card board that is cut to the desired width of fringe plus ¼” seam allowance. Stitch with short stitches at machine, cut open ends of yarn, and pull away cardboard. Insert yarn in fabric seam. This is decorative finish for pockets. There are two types of fringes. They are plain fringe and tied fringe.

- **Plain Fringe:** Fringe of any width can be made from silk or cotton crochet thread or wool yarn by winding 3 or 4 strands at one time around heavy paper. The thread is wound until the desired amount of fringe is needed and machine stitched near the top. Strands were cut at the bottom and the paper is removed. The prepared fringe is then attached on the garment to be decorated (Figure 10.23).



- **Tied Fringe:** The needle with a long eye is threaded with double strands and an upward stitch is made at the edge or a marked line on the fabric. The needle is inserted through the loop and the loop is pulled upwards. This is repeated to a desired number and half of the strands of the 1<sup>st</sup> is tied to half of the strands of the 2<sup>nd</sup>. This is repeated forming a tied fringe (Figure 10.24).

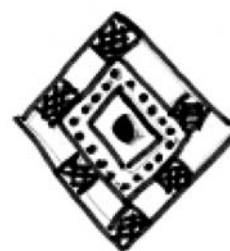


**10.5.1.4. Tassels:** Tassels can be made of any size or colour by using embroidery thread or yarn. It could be made of any thickness and length. For making this, a cardboard is cut of any length to which the length of the tassel to be. then the thread or yarn is wound around it to the desired thickness. The top threads are knotted and the bottom threads are cut. The knotted portion is sewn to the fabric using hand needle.

**10.5.1.5. Lace Work:** Lace can be attached to the fabric in different ways. for attaching the lace at the edge of the fabric, the fabric edge is turned to the wrong side once and the lace is folded in and kept at the wrong side and given a top stitch.

- Lace can be stitched at the edge, centre or seamline. Lace can be gathered at the curved edges. It can be attached to the raw edge by basting the lace close to the edge on the right side of the material, turning the material to the wrong side and rolling the edge of the fabric.
- Lace motifs are attached to the fabric by using running stitches.
- Ricrac is available in different colours at very low cost and is very durable. It can be sewn flat on garment through centre. It adds the beauty of the dress.

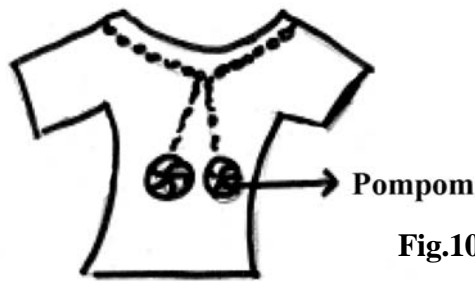
**10.5.1.6. Patch work:** This is an art craft of textiles where more than three pieces are joined together by using machine or hand stitches. In this, size, shape and number of pieces may vary. two pieces are kept right sides facing each other and given machine stitch for plain patch work.



- For quilt top patch method the sponge is kept below the patch piece and given machine stitch.
- For cut and stagger method patch work horizontal strips are joined together and cut and attached according to the required design (Figure 10.25).

**10.5.1.7. Pompon:** This is made of wool, to finish woollen cords. Cut two circular cardboard, for the required size of pompon. Then take the wool from the center to edges, and repeat it tightly to finish the circular. Then cut the outer edge. Tie tightly at center, remove the cardboard. Trim to required size and attach suitably on the garment. (Figure 10.26)

Apart from these there are number of other trimmings as scappoped edges, buttons, belts, knots, shul edges, trapunts, quailing, etc. (Figure 10.26).



**Fig.10.26**

**Conclusion:**

A garment requires some sort of enrichment to make it look unique and to enhance the personality of the wearer. Decorations and trimmings can be learned easily and mastered quickly by all dress makers. It can be used to create one's own style. It also acts as means of income generation.

**QUESTIONS**

**I. Choose the correct answers**

1. \_\_\_\_\_ enrich the garment  
 a) trimmings      b) decorations      c) colour      d) both (a) and (b)
2. \_\_\_\_\_ are introduced during the construction of the garment  
 a) structural decorations      b) surface decoration  
 c) decorative trimmings      d) constructive trimmings
3. \_\_\_\_\_ is a fold of fabric stitched from a specified width to nothing at one or both ends.  
 a) tucks    b) pleats      c) dart      d) gathers
4. When several rows of evenly spaced gathers are used they are known as \_\_\_\_\_  
 a) pleats    b) smocking      c) seaming      d) shirring.
5. \_\_\_\_\_ adds beauty on childrens garments  
 a) smocking      b) embroidery      c) pleats      d) gathering
6. \_\_\_\_\_ type of applied decorations is widely used.  
 a) appliqué      b) printing      c) embroidery      d) sequence
7. \_\_\_\_\_ stitch is used mostly for petal motifs.  
 a) chain      b) blanket stitch      c) laizy daisy      d) none
8. The width of the bias stripe used in piping is \_\_\_\_\_  
 a) 1"      b) ¾"    c) 1½"      d) ½"
9. \_\_\_\_\_ trimming is made out of wool.  
 a) pompon      b) fringe      c) belt      d) none

10. \_\_\_\_\_ is used for finishing edges.

- a) trimmings                      b) decorations                      c) hemming                      d) piping

**II. Two marks**

1. Difference between trimmings and decorations.
2. Define the type of decoration.
3. List the types of applied decoration.
4. Method of making pompon and its application.
5. Uses of trimmings or decorations.

**III. Five marks**

1. Explain the types of trimmings.
2. Write short note on smocking.
3. Explain structural decorations.
4. Use of bias as trimmings
5. Explain embroidered edges and rick-rack.

**IV. Essays**

1. Explain the different types of applied decorations.
2. How to use trimmings and decorations for baby wear and list the points to be remembered while designing with illustrations.

**Keys**

- 1) d,    2) a,    3) c,    4) d,    5) a,    6) c,    7) c,    8) c,    9) a,    10) a



# 11. SELECTION OF FABRICS FOR CONSTRUCTION OF GARMENTS

## INTRODUCTION

The market is flooded with various types of fabrics, ranging in different colours and designs. Careful fabric selection helps in designing good garments and also enhances the comfort and personality of the wearer. Hence, knowledge about the types of fabric available, its design structure and properties along with age of the wearer forms the basic platform in designig a garment.

Fabric selection is governed by a number of factors like age, climate, sex, nationality, purpose of the garment, occassion, activities of the wearer, availability of fabrics in the market, design of the garment and current fashion.

### 11.1. Material Suitable for Infant Garments

Infants or new borns or babies from 0-11 months, their skin is very soft and tender. Hence, soft and smooth textured fabrics which allows adequate movement of air and absorbs moisture readily is best suited for infant wear.

S.No.	Name	Suitable Material	Suitable Design	Suitable colour
1	Jabla	Cotton (Woven)	Printed designs with small motifs	White, pink, blue, yellow, green, purple and orange.
2	Bib	Cotton (Woven)	Small printed motifs	White, pink, blue, yellow, green, purple and orange.
3	Bonnet	Cotton, Wool (Woven and knitted)	Printed designs, knitted	White, pink, blue, yellow, green, purple and orange.
4	Knicker	Cotton (Woven and knitted)	Printed designs (Checks and stripes)	Pink, blue, yellow, green, purple and orange.
5	Panty	Cotton / Satin for party wear (Woven and knitted)	Printed small prints (Floural and figured motives)	White, pink, blue, yellow, green, purple and orange.

### 11.2. Material Suitable for Children Garments

Children are fast growing and very active. Children's age ranges from 1 to 11 years. They are classified as pre-schoole kids, primary school kids and elementary school children. They prefer bright coloured fabrics. Considering their fast growth, deep hems and wider seam allowance are advisable.

S.No.	Name	Suitable Material	Suitable Design	Suitable colour
1	Sunsuit, Romper	Cotton - Woven, Knitted, Denim	Stripes, Checks, Small Flower and Geometric motives, Cartoon designs	Light shades, Grey, Brown, Green, Blue
2	Baby frock & Its variations	Cotton, Satin, Blended fabrics, Net fabrics, Silk, Synthetic fabrics, Denim	Plain, Printed, Stripes, Checks, Floral motives, Surface Enrichments, Cartoon designs.	White, pink, blue, fluorescent orange, yellow, green
3	Pant, Shorts	Denim, Cotton, Blended Fabrics	Checks & Plaids, Woven designs	Navy blue, bottle green, gray, black, brown
4	Shirts	Cotton, Blended fabrics, Denim	Floral, Geometric, abstract motives, Embroidery designs	White, blue, green, brown, grey
5	T-Shirt	Cotton woven, Knitted	Printed designs	Yellow, green, blue, black, gray, red

### 11.3. Material Suitable for Adolescent Girl's Garments

Adolescent period is the most curious period of growth, where one transfers from childhood to adulthood. Their growth is rapid with both physical and mental changes. Similarly their dressing sense changes from parental guidelines to peer group fashion garments.

S. No.	Name	Suitable Material	Suitable Design	Suitable colour
1	Salwar and Kameez	Cotton, Silk, Satin, Synthetics, Blended fabrics	Printed, Woven designs, Surface enrichments, Dyed designs	White, pink, green, blue, yellow, orange, brown, red.
2	Skirt and Kurta	Cotton, Silk, synthetic & blended fabrics, Denim	Printed, Dyed, surface enrichments - Embroidery	White, light blue, pink, light green

3	Middy and Middy Top	Cotton, Silk, Synthetic & Blended fabrics, Denim, Velvet	Printed, Dyed, Woven designs, Surface enrichments - Embroidery and laces.	White, pink, green, blue, yellow, orange, brown, red.
4	Pant and Top	Cotton, Denim, Blended fabrics	Printed, Woven designs	Pant -Black, gray, blue, brown, red. Top - White, pink, green, blue, yellow, orange, brown, red.

#### 11.4. Material Suitable for Adolescent Boy's Garments

Adolescent boys also have rapid growth like adolescent girls. The shoulder broadens and height increases. Their clothing selection is directed towards their peer groups costumes and their favourite hero on silver screen. Hence fashion lays the foundation for adolescent boys garments.

#### 11.5. Material Suitable for Men Garments

Men's garments are governed by the availability of fabrics in the market and their regular activities. The age of men ranges from 21 years to their last. It divided into early adult hood, middle age and late adult hood. During late adulthood, they prefer soft textured plain fabrics of pastel shades.

S.No.	Name	Suitable Material	Suitable Design	Suitable colour
1	Shirt	Cotton, Denim, Blended fabrics	Stripes, checks & plaids, abstract, geometric designs.	Blue, green, brown, black, cream, gray
2	T-Shirt	Cotton, Knitted and Blended knitted fabrics	Geometrical designs and small prints	Yellow, blue, white, gray, black, brown, cream, red.
3	Shorts, Bermudas	Cotton, Denim, Blended fabrics, Woven and Knitted fabrics	Checks and plaids, stripes	Blue, green, brown, black, cream, gray
4	Pant	Denim, Cotton, Blended fabrics	Woven designs	Black, grey, brown, blue, green, gray, white.

### 11.6. Material Suitable for Women Garments

Women's garments are highly influenced by high tech fashion on one hand and the traditional cultures of their home land. Depending upon this fact, the textile manufactures have flooded the markets with a wide range of colourful textile fabrics. Women's garments are governed by their activities and physical structure.

S.No.	Name	Suitable Material	Suitable Design	Suitable colour
1	Sari Petticoat	Cotton, Satin (Woven)	Plain	Black, white, brown, red, blue, green, yellow, pink, orange
2	Maxi, House coat	Cotton, satin, blended fabrics	Floral, abstract, geometric, conventional motives	Red, blue, green, yellow, pink, orange
3	Saree blouse	Cotton, silk, blended fabrics, velvet, netted and laced	Woven designs, surface enrichments, print designs	Black, white, brown, red, blue, green, yellow, pink, orange
4	Night wear	Cotton, blended fabrics	Woven, knitted with small designs	Light pink, blue, green, yellow, gray

### 11.7. Material Required for selected Garments

It is always helpful to have some basic knowledge about the garment, its fullness and trimmings before one steps into a shop to buy material. The above mentioned aspects will enable one to calculate the amount of material to be purchased. One can also avoid being carried away by the shop keeper's words and land up in buying more or less amount of material. It can also reduce one's tension while laying the patterns for marking and cutting.

The table below serves as a yardstick to understand the amount of material required for commonly used garments. This table is framed for 36" width material. In case the width is more, namely 42 or 60 inches, one can reduce 20 to 30cms respectively from the amount required.

S.No.	Name of the Garment	Material Required		
		One way design	Stripes	Plaids
1	Jabla	Half meter of suitable fabric	Half meter of suitable fabric	Half meter of suitable fabric + 4"
2	Panty (3 yrs. old)	Panty length + 6"	Panty length + 6"	Panty length + 6"
3	Knicker (3 yrs.)	Knicker length + 6"	Knicker length + 6" + 2"	Knicker length + 6" + 4"
4	Romper	1 meter	1 meter	1 meter + 0.25m
5	Frock variations			
a)	Plain frock (without sleeve & collar)	Frock length + 5"	Frock length + 5"	Frock length + 5"
b)	A-line frock (with sleeve & collar)	Frock length + sleeve length + 6"	Frock length + sleeve length + 6" + 0.25m	Frock length + sleeve length + 6" + 0.50m
c)	Gathered Frock (collar & puff sleeve)	Twice frock length + sleeve length + 9"	Twice frock length + sleeve length + 9" + 0.25m	Twice frock length + sleeve length + 9" + 0.50m
6	<b>Skirts (4-8 Yrs)</b>			
a)	Plain short Skirt with minimum flare	Two skirt length + 6"	Two skirt length + 6"	Two skirt length + 6"
b)	Gathered skirt	Twice Skirt length + 6" + 4" for band	Twice Skirt length + 6" + 4" for band	Twice Skirt length + 6" + 4" for band
c)	Pleated skirt	Thrice skirt length + 6" + 4" for band	Thrice skirt length + 6" + 4" for band	Thrice skirt length + 6" + 4" for band
d)	Full skirt	Twice skirt length + 6"	Twice skirt length + 6"	Twice skirt length + 6"

S.No.	Name of the Garment	Material Required		
		One way design	Stripes	Plaids
7	<b>Blouse</b>			
a)	34 - 36"	Back waist length + sleeve length + 10"	Back waist length + sleeve length + 10" + 0.20m	Back waist length + sleeve length + 10"+0.25m
b)	30-32"	Back waist length + sleeve length + 5"	Back waist length + sleeve length + 5" + 0.20m	Back waist length + sleeve length + 5" + 0.25m
c)	38-40"	Twice back waist length + sleeve length + 3"	Twice back waist length + sleeve length + 3" + 0.30m	Twice back waist length + sleeve length + 3"+ 0.50m
8	Salwar	Twice garment length + 10"	Twice garment length + 10" + 0.25m	Twice garment length + 10" + 0.25m
9	Kameez	Twice garment length + 10" (2 meter) + 0.5m	Twice garment length + 10" (2 meter) + 0.5m	Twice garment length + 10" (2 meter) + 0.5m
10	House coat	Twice garment length + sleeve length + 12"+0.5m	Twice garment length + sleeve length + 12" + 0.5m	Twice garment length + sleeve length + 12" + 0.5m
11	Pant	Twice pant length + waist belt width (4") + 6"	Twice pant length + waist belt width (4") + 6"	Twice pant length + waist belt width (4")+ 6"
12	<b>Shirt</b>			
a)	Slack shirt (6 yrs)	One shirt length + 6" + sleeve length + 0.25m	One shirt length + 6" + sleeve length + 0.25m	One shirt length + 6" + sleeve length + 0.50m
b)	Full shirt with Yoke (6 yrs)	2 full length + 8" + 0.25m	2 full length + 8" + 0.25m	2 full length + 8" + 0.50m
c)	T-Shirt (6 yrs)	Twice full length + sleeve length + 4" + 0.25m	Twice full length + sleeve length + 4" + 0.25m	Twice full length + sleeve length + 4" + 0.5m
13	Kurta (6 yrs)	Twice kurta length + 2" + 0.30m	Twice kurta length + 2"+0.30m	Twice kurta length + 2" + 0.5m

S.No.	Name of the Garment	Material Required		
		One way design	Stripes	Plaids
14	Pyjama (10 years)	Twice the garment length + 6"	Twice the garment length + 6"	Twice the garment length + 6"
15	Saree petticoat (6 gore or 4 gore)	Twice the petticoat length (2.10m)	Twice the petticoat length (2.10m)	Twice the petticoat length (2.10m)
16	Sun suit (3 years)			
a)	Sleeveless shirt with straight collar	Shirt length + 6" + 0.10m	Shirt length + 6" + 0.10m	Shirt length + 6" + 0.20m
b)	Sleeve & peter pan collar	Shirt length + sleeve length + 8" + 0.15m	Shirt length + sleeve length + 8" + 0.15m	Shirt length + sleeve length + 8" + 0.30m
c)	Shirt with yoke, sleeve, collar and pleated or gathered lower section	Two shirt lengths + 4" + 0.20m	Two shirt lengths + 4" + 0.25m	Two shirt lengths + 4" + 0.25m
17	Knicker	Knicker length + 6"	Knicker length + 6"	Knicker length + 6"

## 11.8. Construction of a Garment

Construction of a garment is a beautiful art, which requires skill, practice and inborn interest. One has to slowly go through the steps of garment construction and review it often to sew comfortable and well fitted garments.

### 11.8.1. Steps to be Followed in Garment Construction

The major steps involved in garment construction are (General)

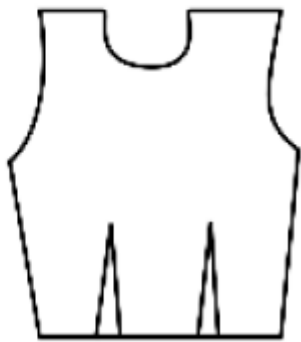
- Check if all the patterns are cut
- Fold the patterns and keep them safely
- Open the patterns only while sewing
- Match the notches, before sewing
- Check if the curved lines are stay stitched

- Collect all the necessary accessories before starting to sew
  - Eg. Lining material for collars.
  - Fasteners
  - Decorative laces, appliqués
- Check the colour of the machine thread. If the fabric has more than two colours, try to get the dominating colour threads
- Fill the bobbins with suitable colour threads
- Oil the machine and run it over waste cloth
- Check the smoothness of the machine
- Clean the machine thoroughly especially the bobbin holder and feed back

#### **11.8.2. Steps Involved in Construction of an Upper Garment (A bodice Pattern)**

- In case the pattern has darts, finish it first (Figure 11.1).
- Join the shoulders to neck line
- Join the side seams
- Finish the placket opening
- Finish the neck line
- Join the under arm seams of the sleeves
- Check front and back sleeve patterns and attach the sleeve to the bodice pattern
- Finish the hem lines
- Attach fasteners
- Press neatly





**Marking the darts**



**Stitching the darts**



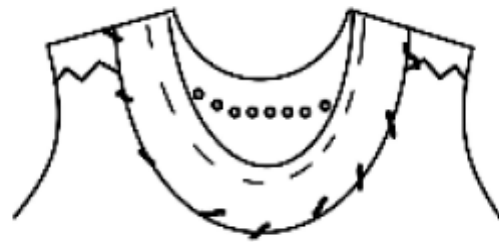
**Joining the shoulders seams**



**Joining the side seams**



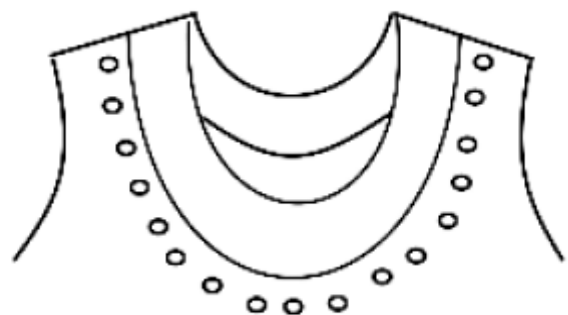
**Finishing the plackets**



**Attaching the bias piece to the neck line**

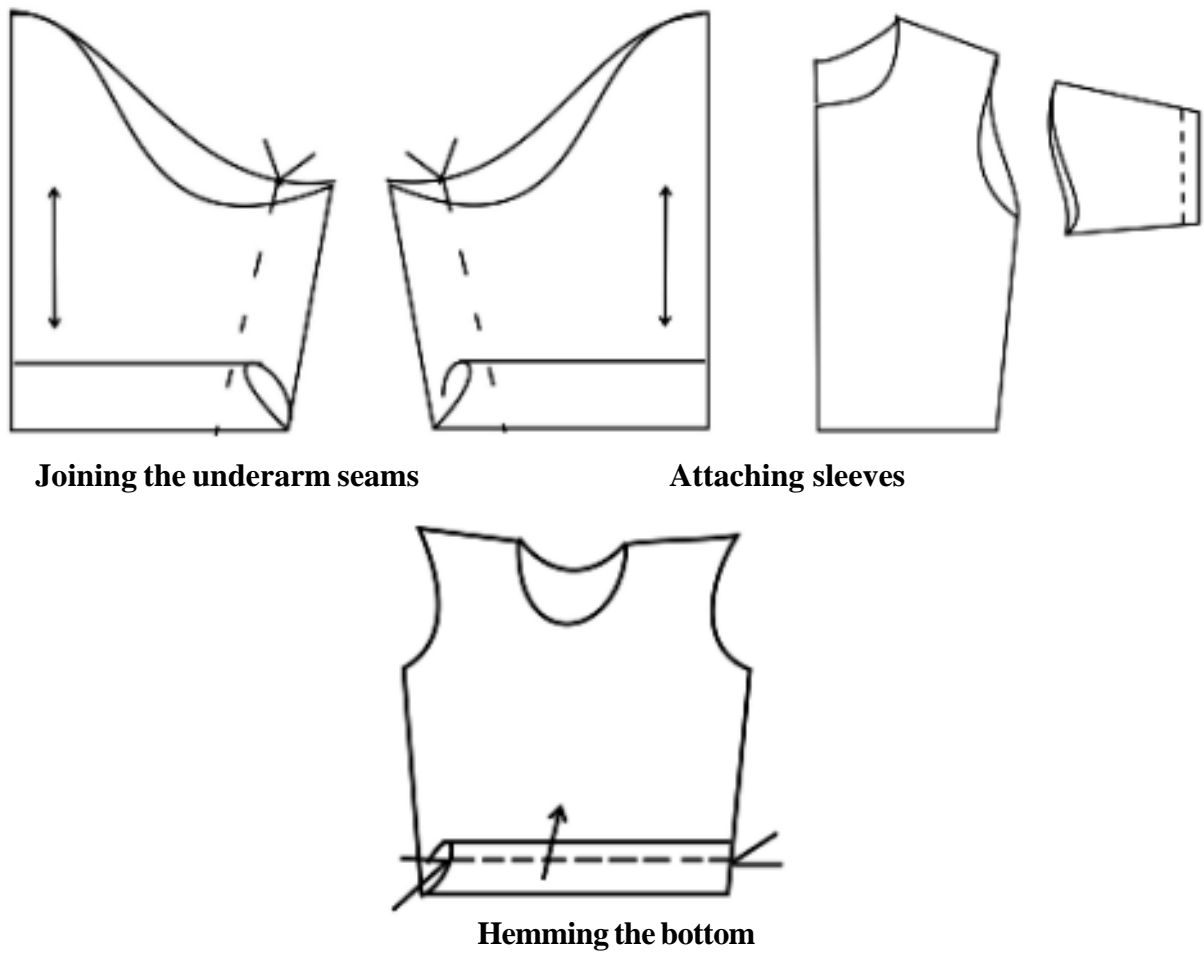


**Turning the bias strip and hemming**



**Finished neck line**

**Fig. 11.1**



**Figure 11.2**

**11.8.3. Steps Involved in Construction of a Lower Garment (Skirt Pattern)**

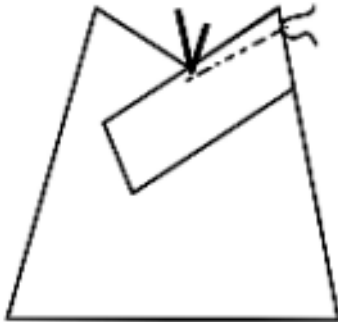
- Complete the darts
- Finish the plackets
- Join the side seams
- Attach the waist band
- Fix fasteners
- Press neatly
- Finish the front opening placket
- Attach yoke to the back (Figure 11.2)



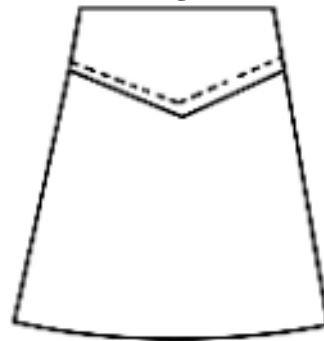
**Marking darts**



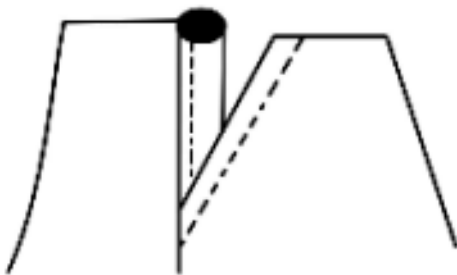
**Stitching darts**



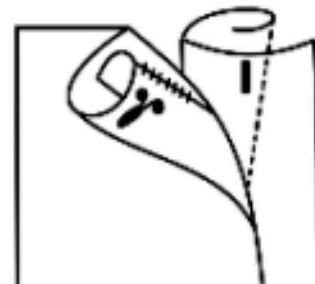
**Joining yoke (for yoke skirts)**



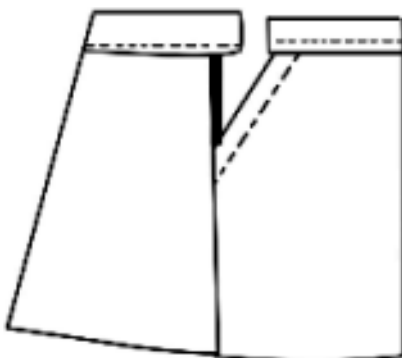
**Turning to right side and top stitching**



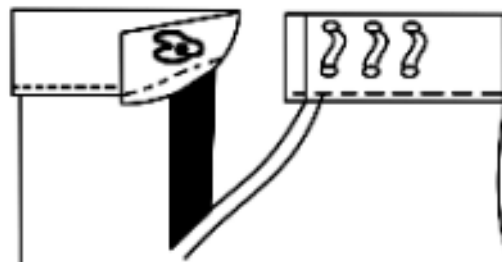
**Attaching plackets**



**Marking fasteners**



**Joining waist band**



**Sewing fasteners**

**Figure 11.3**

#### **11.8.4. Construction of a shirt**

Part of the shirt

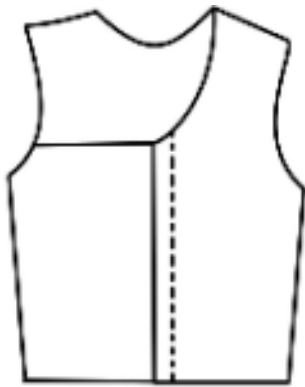
- Front pattern
- Back pattern
- Yoke pattern
- Collar Band pattern
- Main Collar pattern
- Pocket pattern

##### **11.8.4.1. Attaching Yoke to the Back**

- Mark centre notches to the back piece of shirt and center notches to the yoke pattern.
- Placing yokes one at front and back, of back shirt pattern.
- Make ½”stitch from the edge.
- Then turn the yoke and give a top stitch
- Join the shoulder seams of front and yoke.
- Attach collar to the necklines as given in figure 11.3

##### **11.8.4.2. Shirt collar**

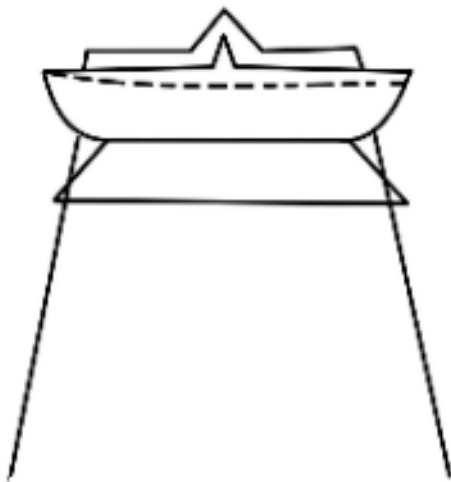
- This collar has two parts (i) the collar band and (ii) the main collar.
- Draft the pattern with stand collar combined
- Shirt collars are usually finished with an interfacing.
- The interfacing should be preshrunk and its corners at the outer edge clipped to avoid bulk when the collar is turned.
- Tack interfacing to the wrong side of under collar section and stitch upper and under collars together, right sides facing.
- Trim and grade seam allowances, cut off corners and turn the collar to the right side.
- Top stitch around the outside edges of collar ¼” from edge.
- Insert the collar between inner and outer band sections matching centre front and centre back markings and stitch on the seam line.



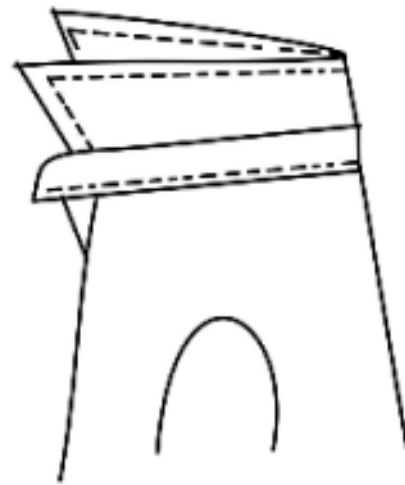
**Attaching yokes**



**Finishing collar with canvas**



**Attaching collar to shirt**



**Turning collar and top stitching**



**Attaching sleeves**



**Finishing side seams**

**Figure 11.4**

- Tack the inner band to the neckline of the shirt and stitch.
- Fold seam allowance of the upper band and tack to the seam line. Then top stitch around the collar band
- Finish sleeve hems
- Attach sleeves to the shirt
- Finish side seams from the sleeves to the bottom
- Finish hem line
- Complete the shirt with buttons and button holes (Figure 11.3)

### **11.9. Sewing Tips**

1. All seams need double machining. This little extra effort during sewing will ensure that the seams do not rip easily.
2. While sewing the shoulder seams, start from the armhole edge to the neck edge, turn and double-machine the seam, making sure that the second stitch line does not shift from the seamline.
3. All straight seams should be stitched absolutely straight; any irregularities will appear magnified after the garment has been completed.
4. While attaching a facing, keep the work piece flat on a table.
5. While making gathers, set the machine on the largest stitch size, loosen the top tension slightly and machine two rows, one on the seam line and one 0.56 centimeter above it. Wind the top threads round a pin and pull up to the desired length by the bobbin thread only. Ease the fabric gently while pulling to avoid breaking the thread.
6. While attaching an eased or gathered section of a garment, always keep it on top to ensure evenness and to keep the gathers from shifting.
7. While attaching pockets and while stitching down the pleats, double-machine the edges for reinforcement.
8. While attaching ruffles or lace, provide extra ease at the corners.
9. A curved seam is stitched in the same way as a plain seam but the edges are notched so that the seams may be pressed flat. Curved seams are pressed on a Tailor's Ham so that the curve does not flatten during pressing.
10. A bias seam must be sewn with a looser tension to prevent puckering. Never pull edges that are cut on the bias while sewing or they will get stretched permanently. If a straight edge is being attached to a bias edge, have the bias on the underside.

11. While hemming, remember that the edge of a skirt is seldom straight and even a slight curve will affect the way a hem is stitched. A narrow hem is easy to fold along the curves. When the hem is wide, it may be finished in the following ways:
  - i. For an A-line dress or skirt, the hem is folded before stitching the side seam line, so that the hem matches the slant of the side seam.
  - ii. Narrow folds may be introduced at regular intervals along the hem edge. Attach this to a bias tape and then hem into position.

## CONCLUSION

This chapter helps one to understand the basic construction techniques and the method of calculating the material required for the most commonly used garments. If one goes through the various aspects of lesson one can gain confidence in selection and construction of an appreciable garment to make one's personality more attractive and pleasing.

## QUESTIONS

### I. Fill in the Blanks

1. Check if the curved lines are \_\_\_\_\_
2. Fill the \_\_\_\_\_ with suitable colour threads.
3. Double machining will ensure that the seams do not \_\_\_\_\_
4. While making \_\_\_\_\_, set the machines on the largest size.
5. While attaching \_\_\_\_\_ provide extra ease of the corners.
6. A \_\_\_\_\_, is stitched in the same way as a plain seam but the edges are notched so that seams may be pressed flat.
7. A \_\_\_\_\_, seam must be stitched with a lesser \_\_\_\_\_ to prevent puckering.
8. While \_\_\_\_\_, remember that the edge of a skirt is seldom straight and even a slight curve will effect the way a hem is stitched.
9. Shirt collors are usually finished with \_\_\_\_\_
10. \_\_\_\_\_ around the outside edge of collar.
11. Join the shoulder seams of \_\_\_\_\_ & \_\_\_\_\_
12. Place yokes one at \_\_\_\_\_ & \_\_\_\_\_ of back shirt.
13. This collar has two parts namely \_\_\_\_\_ & \_\_\_\_\_
14. Construction of a \_\_\_\_\_ is a beautiful art.
15. Shirt collars are usually finished with an \_\_\_\_\_

16. Complete the shirt with \_\_\_\_\_ & \_\_\_\_\_ Holes
17. \_\_\_\_\_ may be stitched at regular intervals along the hem edge.

## **II. Answer in Short**

1. What are the two parts of collar?
2. What is interfacing?
3. How is hemming done?
4. How the nothches is done?
5. What is gathering?
6. List the parts of a shirt.
7. What are the steps involved in constructing lower garment (Skirt pattern)?
8. Mention any two sewing tips.
9. How should the machine be krpt before constructing a garment.
10. Define construction of a garment.
11. Review the steps involved in garment construction.
12. Which parts of the machine should be cleaned before starting to sew?

## **III. Answer in Detail**

1. What are the steps involved in garment construction?
2. What are the steps involved in the construction of an upper garment?
3. How should you attach yoke to the back?

## **IV. Explain in Detail**

1. Explain about shirt collar and its stitching.
2. Explain briefly about sewing tips.
3. List the steps involved in skirt construction.
4. List the steps to be followed in garment construction.
5. Give a detailed account of the procedure followed in shirt construction.

## **Answers**

### **I. Fill in the Blanks**

1. Stay stitched, 2. Bobbin, 3.rip easily, 4. gathers, 5.ruffles or lace, 6. curved seam, 7. bias, tension, 8.hemming, 9. Interfacing, 10. top stitch, 11. front & back, 12. front & back, 13. collar stand & collar band, 14. garments, 15. Interfacing, 16. Button and button holes, 17.slip stitch



## **12. READYMADE, TAILOR MADE AND HOME MADE GARMENTS**

### **INTRODUCTION**

In the present changing life style, each and every member in the family likes to follow latest trend with regard to their wardrobe. They want to dress up neatly, like to display their status. In today's fast moving life, it is very difficult to take the time for getting clothes stitched. We have to go to the market to buy a fabric, look for a tailor order stitching and wait till the dress is ready. To overcome this problem we have an alternative method of buying a ready made dress. Almost for all occasions family members prefer to buy their garments from the leading ready made shops. They are abundantly available for all the age groups. Accessories also available suitably along with the garments.

### **12.1. READYMADE**

The garments which are available readily in the shops for different age groups with varied colour combinations, upto date styles, latest prints, trims and also suitable for different occasions and seasons are known as readymade garments.

#### **Ready made garments are sold by**

- Leading whole sole dealers
- Branded showrooms
- Retail outlets
- Small scale boutiques
- Door to door vendors

#### **Readymade garments are available on the basis of standardized body measurements for**

- New born
- Toddlers
- Pre schoolers
- School going children
- Teen agers
- Old age adults

#### **The garment sizes available for each age group are mentioned as**

- Small
- Medium
- Large
- Extra large

**Readymade garments are available for boys, girls, men and women suitable for various purposes, which are categorized as**

- Regular wear
- Occasional wear
- Special occasions
- Sleep wear

**Apart from this, ready made garments also available for special events like**

- Sports wear
- Swim wear
- Karate dress
- Dance dress
- Walking and jogging wear
- Bridal dress

**Reasons for Choice of Ready Made Garments**

- Latest styles
- Up to date fashion trends
- Appealing designs
- Amazing prints
- Different colour variations
- Maximum colour combination
- Wonderful weave patterns
- Aesthetic finish
- Different textures
- Reversible garments
- Mix and match styles

**Seasonal Garments for all Age Groups:** They are as follows,

- Winter clothing
- Summer clothing
- Clothing for all seasons

Ready made garments are available for all income groups. The price of the garment is left purely on the persons choice. If the person want to buy with minimum cost, definitely they can buy within their budget. Those who wish to go for branded garments / no doubt should bear the cost because of the quality.

### **The points to be considered while buying ready made garments**

Beforehand, the person should think of what to buy, where to buy, how much to buy and the budget allotment. The following points should be taken into consideration while buying readymade garments:

- Reliable shop
- Suitable for the occasion
- With in the budget
- Correct size/fit
- Becoming colour
- Pleasing design
- Latest print
- Right choice for the amount paid
- Suitable to the climate
- Adequate trims / workmanship
- Fast colour
- Accepted style
- Wash and care instructions/ label information
- Satisfaction

**At present in almost all the shops owners sell their garments with sales promotion motives. They are as follows.**

- Discounts
- Providing gifts/gift coupons
- Buying today paying tomorrow
- Buy one and take two or three
- Bonus points for the purchase exceeds for a particular amount

As on today we can see most of the population is attracted or moved or tempted to buy by means of catchy advertisements displayed by mass medias which plays an important role.

**One should consider the following personal characteristics while buying their garments.**

- Age
- Occupation
- Economic status
- Life style

- Personality
- Self concept

**The psychological factors which influence the people are**

- Motivation
- Perception
- Attitudes
- Reasoning belief

**One should be aware of the following aspects so as to alert and give no chance to manufacture or retailer to malpractice, namely**

- Giving lesser quantity
- Cheating on price
- Selling defective goods
- Providing false, misleading and incomplete labels and markings

## **MERITS AND DEMERITS OF READY MADE GARMENTS**

### **MERITS**

- Readily available
- Variety in style and materials
- Garments for various seasons and occasions could be purchased whenever necessary
- Saves times spent on construction as in case of tailor made and home made garments
- Current trends could be updated
- Branded goods could be purchased on availability
- Easy care fabrics with label instructions
- Buyer can try out the garments for personal fitting

### **DEMERITS**

- Need to know proper size
- Projects the taste of the buyer
- Proper fitting is not possible some times
- Expensive than tailor and home made garments
- Some of the ready made garments are less durable due to poor quality in stitching

## 12.2. TAILOR MADE GARMENTS

The garments which are constructed with the help of a tailor based on requirement are known as tailor made garments.

A Tailor is a person who makes garments, repairs or alter clothing professionally. A skilled tailor can make simple clothing from common material, but with time and practice they can learn to create garments of great quality and beauty. A tailor progresses and becomes more skilled as they are able to design beautiful clothing and accessories to compliment every kind of adventure. Sewing professional work inside the home or out of their home and may work part time or full time.

### Types of Tailoring

Tailoring profession has evolved the methods of tailoring, which are as follows

- Local tailoring
- Distance tailoring
- Traveling tailoring

**Local Tailoring :** Typically the tailor in met locally and the garments produced locally. This method enables the tailor to take professional measurements, assess posture and body shape to make unique modifications to the garment. Local tailors have a show room. This is the most traditional form of tailoring.

**Distance Tailoring :** This involves ordering a garment from a tailor who is out of town enabling cheaper labour to be used. This can now be done on global scale via e-commerce website. Unlike local tailoring, customers must take their own measurements, fabric selection must be made from a photo and if further alternatives are required the garment must be sent. Today the most common platform for distance tailoring is via online tailors.

**Traveling Tailoring :** This is an attempt to blend the best of local and distance tailoring. Commonly these tailors will operate out of area, which have a strong tailoring trade or low labour cost but spend much of their time traveling to major cities to meet the clients. On their visits they take measurements and showcase physical fabric samples, once the client places an order, the garment is manufactured elsewhere and delivered via courier or mail. This method has the advantage of allowing tailors to meet the clients and make professional assessment of the fit with lower labour costs of distance tailoring.

The garments could be constructed at home or with the help of tailors efficiently. If the members in the family are not interested in tailor-made or homemade garments, they can buy their garments from readymade shops as they wish and whenever required.

### The Merits and Demerits of Tailormade Garments

#### Merits

- Economical
- Proper fit is obtained
- Helps to select unique style
- Time saving when compared to home made garments

### **Demerits**

- Need to depend on tailors
- Improper fitting
- Time consuming when compared to ready made
- Not possible to get quality finish
- Availability of minimum styles
- Expensive

### **12.3. HOME MADE GARMENTS**

The garments which are constructed efficiently at home as and when required for the family members to express their talents and interest are known as home made garments.

If the members in the family are interested and talented in garment construction, they can very well produce garments in the home.

### **Merits**

- Economical
- Requires special talent and involvement
- Need not depend on any one
- Helps to create unique style
- Though it is time consuming ,satisfaction could be achieved in fit and comfort
- Quality garments could be produced based on the availability of the sewing machines and finishing machines
- Helps to unique style
- Motivate creativity
- Needs adequate knowledge and skill in construction
- Enrich the knowledge experience by multiple and regular constructions.
- Applications of CAD simplifies the procedure.
- Current trends could be updated.

### **Demerits**

- Time consuming
- Needs special skill and talent
- Perfections equal to readymade is impossible.
- Needs adequate knowledge about material types of styles. Only then could be managed.

## QUESTIONS

### I. Choose the correct answer

1. Almost for all occasions members in the family prefer \_\_\_\_\_ garments.  
a) tailor made    b) homemade    c) readymade    d) none of the above
2. After you have selected a dress from the shop you have to see the \_\_\_\_\_ & \_\_\_\_\_.  
a) design and fit    b) colour and fit    c) texture and fit    d) fit and cost
3. The consumers are attracted or moved or tempted to buy by means of catchy \_\_\_\_\_.  
a) sales    b) advertisements    c) press    d) mass media
4. \_\_\_\_\_ is a general term for those who make living by sewing  
a) sewing professional    b) designer    c) master    d) merchandiser

### II. Write short answers

1. Define the terms readymade, tailor made and homemade.
2. List the merits of readymade garments
3. State the advantages of homemade garments.
4. Enlist the points to be considered while buying readymade garments.
5. What are the malpractices that might be faced during purchase of clothing.
6. Who is a tailor?

### III. Give brief answers

1. Bring out the differences between homemade and tailor made garments.
2. Discuss the reasons for opting readymade garments.
3. Explain the types of tailor.

### IV Give detailed answers

1. Enumerate the role of readymade garments in the present scenario.
2. Why homemade garments are superior than readymade and tailor made? Justify.
3. Explain tailor made garments with justification.

# 13. CARE AND MAINTENANCE OF GARMENTS

## INTRODUCTION

A garment that is properly cared for may be expected to last considerably longer than one that is not cared for adequately. It will look better all through its wear-life.

Care includes three elements namely cleaning, refreshing and storage. Cleaning is usually a more technical and more involved process than storage or refreshing. Washing and dry cleaning are two major overall cleaning methods. Washing may be either hand or machine. For either process there are variations in the required water temperature, the nature of the detergent used, the use of bleach, the length of soaking and agitation time, the method of moisture removal and the method and amount of pressing required.

### 13.1. Washing

Washing is one way of cleaning namely with water and often with some kind of soap / detergent. It is an essential part of good hygiene and health.

#### 13.1.1. Principles of Washing and Their Application

Home laundering is an art. It requires patience and practice to learn the right technique. Laundering of clothes consists of two processes – removing dirt from clothes and finishing them to regain the appearance of neatness as a new fabric.

The dirt which soils fabrics may be classified as follows:

1. Loose dirt resting on the fabric.
2. Fixed dirt which is held by grease.

Loose dirt is removed by steeping and mechanical means such as brushing and shaking. Fixed dirt is removed by means of absorption or emulsification of washing and dry cleaning. Soap plays an important part in the separation of dirt, but the fact lies how the soapy water is allowed to penetrate the fabric. The essential factor in the process of cleaning therefore is the use of grease solvent or absorbent and an application of hard or delicate pressure to remove the dirt.



### 13.1.1.a) Application of Pressure is Done in Different Ways

S.No.	Method of washing	Process	Use
<b>1.</b>	<b>Application of Friction washing</b>		
	<b>Hand Friction</b>	1. Wring the article out of steeping water. 2. Apply soap to the most soiled parts and rub one part against the other until the dirt is loosened. 3. Rinse out of all soap with warm water.	Suitable for much soiled small articles made of cotton or linen
	<b>Friction by use of a scrubbing brush</b>	1. wring the article out of steeping water. 2. Spread on a flat surface and rub over with the cake of soap. 3. It is scrubbed and work over the whole of the fabric in the way. 4. Rinse out of all soap with warm water.	Suitable for very soiled articles of any coarse strong fabrics
<b>2</b>	<b>Application of light pressure</b>		
	<b>Washing by kneading and squeezing</b>	1. Prepare one or two washing waters of the correct temperature (100-110°F) with a permanent lather according to the number of articles to be washed 2. Knead and squeeze the soiled fabric in the warm soapy water. Very soiled parts should be placed on the palm of the left hand and have additional lather placed until the dirt is loosened. 3. Rinse thoroughly to remove all traces of soap.	Suitable for delicate fabrics to which hand friction cannot be applied as in wool, silk, rayon and coloured fabric.

### 13.1.1.b) General Procedure for Hand Laundering:

Although most of today's fabrics are either machine washable or dry cleanable, hand washing continues to be important not only for small items but also for certain materials like silk, sheer fabrics where fastness of colour is uncertain, must be washed by hand.

Following are some guides for hand laundering.

- Launder fabrics before they become too soiled.
- Examine the fabrics thoroughly for spots, small tears or holes.
- Mend all tears or holes and mark spots with thread so that they may be specially treated before or during washing.
- Remove any accessories that are not washable.
- For delicate fabric use soap with no strong alkali.

### **13.1.2. Washing by Machine**

Most washing today is done by washing machines, the great majority of which are the automatic types. In selecting an automatic washing machine, the following are important consideration for the customer.

- Capacity of clothes depending on family size
- Space available for the machine
- At least two speed variations for different fabrics
- The water temperatures
- Pressure control rather than time control for filling
- More than one full level to handle a small load
- Moderate use of electricity

#### **There are certain cautions to observe in using an automatic washer**

- Turn off the water supply when the machine is not in use, to prevent the hose from recapturing
- Remove the articles from the clothing pockets before washing.
- Keep hands out of the washer when it is in operation.
- Don't over load the machine. Distribute the loads evenly, if the machine vibrates or bang, turn it off at once.

#### **The following are the general procedure:**

Before using a washing machine it is important to study the maker's instruction.

- Fill the machine to the water level with warm water. Add soap solution or powder.
- See that heavily soiled garments have some soap rubbed in before being placed in the machines.
- Sort clothes into white, coloured and delicate fabrics.
- Load the machine with required quantity of garments
- Set the wash cycle, temperature, warm or hot water and timing, switch on for washing.
- Remove the garments once the washing is over.
- Dry the garments in the sunlight or in the shade.

### **13.1.3. Fabric softeners**

The purpose of fabric softeners is to make washable fabrics softer, fluffier and less likely to wrinkle, and to make ironing easier. When used on man made fabrics, softeners are said to cut down on static electricity (clinging of the fabric).

While many different fabric softeners are available, most of them are in liquid form. One type of softener is added to the final rinse water, where as another type is to be put in to the water along with the detergent. With the latter type, it is important to follow instructions carefully because the softener and detergent interact, causing an insoluble precipitate that is difficult to remove.

## 13.2. BLEACHING

Bleaching is a complex process of removing colouring or discoloured matter from fabrics and made white. In laundering, the only object in using bleach is to remove stains, which do not respond to normal washing processes. Bleaching should be carried out carefully on all fabrics. Bleaching agents are chemicals hence the correct rate and intensity of bleaching is essential so as to avoid damage to the fabric.

On the basis of mode of action, bleaching agents can be classified into three groups as below.

2.1. Oxidizing bleaches

2.2. Reducing bleaches

2.3. Optical bleaches

**13.2.1. Oxidizing bleaches:** These have oxygen as a chief component which is liberated and on contact with the stain, forms a colourless compound.

**13.2.2. Reducing bleaches:** These remove the oxygen from certain kind of stains and so, reduce them to a colourless compound.

**Amongst the oxidizing bleaches, the following may be mentioned:**

- Sunlight with moisture, air and grass
- Sodium Hypochlorite
- Sodium perborate
- Hydrogen peroxide
- Potassium permanganate

**1.a) Sunlight with Moisture, Air and Grass :** This is the oldest, easiest, cheapest and perhaps the best method of bleaching cotton and linen, and of removing colouring matter which on contact with oxygen becomes colourless. The oxygen from the air and grass liberated by the sunlight and in conjunction with moisture is the active bleaching agent. The article, particularly the stained part, must be moistened with water and exposed to the sun preferably on grass or shrubs or plants until the colouring matter disappear after which the fabric must be removed immediately. Otherwise long exposure to the sun will weaken it.

Before bleaching with any of the oxidizing chemical, the metallic buttons and other similar parts if any, must be removed since their oxidation may cause black stains on the fabric.

**1.b) Sodium Hypochlorite or Javelle Water :** 1lb (480g) washing soda  $\frac{1}{4}$  lb chloride of lime, 1 quart boiling water 2 quarts cold water.

**Method:** Take a solution of washing soda and boiling water. Mix chloride of lime with cold water. Stand the mixture for sometime, so as to settle down. Decant the clear liquid and add it to the washing soda solution. This will give sodium hypochlorite and calcium carbonate which will precipitate. Allow the precipitate to settle and then strain off the clean liquid. This must be always stored in coloured bottles as it deteriorates in the light.

**Use:** Sodium hypochlorite is a strong bleaching agent and can be used on white cotton and linen. Dilute it with equal quantity of hot water and sponge the strained portion with it until the stain is removed. Rinse the fabric in the plain water to wash out any residual amount of bleach.

**1.c) Sodium Perborate bleach :** It is made by mixing solution of borax and caustic soda with hydrogen peroxide. When mixed with warm water, it gives off oxygen and also forms an alkaline solution of hydrogen peroxide, and is used in the preparation of soap powders.

**Method:** Dissolve one ounce (about 28g) of chemical in one gallon (about 4 litres) of water. For treating animal fibres, neutralize the solution with acetic acid and for bleaching action makes it slightly alkaline with ammonia.

**Use:** Make a solution of sodium perborate in the proportion of one tea spoon to 1 pint of boiling water. Sponge the stain with this solution, mostly used on white linen and cotton.

**1.d) Hydrogen Peroxide :** It is used as an antiseptic and a deodorant. It is a mild and useful agent. It must however be used with great care as it may cause serious injury to fabrics. The compound is available in the market as solution of different concentrations. The chemical is very unstable in air. Hence, to maintain the strength for longer, it must be stored in dark air tight bottles at low temperature. This bleach readily splits up into water and oxygen and so colouring matter is oxidized in its presence. This action takes place most rapidly with alkaline solution.

**Use:** It is a safe bleach on all fabrics and is used for whitening of wool and silk in addition to cotton and linen, which show yellowness due to repeated washings. It must never be allowed to dry in the fabric. The 10 volume strength can be used without dilution for white linen and cottons but for other fabrics, it should be diluted by adding six parts of cold water to one part of hydrogen peroxide. Little ammonia is then added to make the solution alkaline.

**1.e) Potassium Permanganate Bleach :** This bleach has a high content of oxygen which will combine with, so remove, certain obstinate stains. Eg., perspiration, marking ink and mildew. It can be used on animal as well as vegetable fabrics. A brown colour is left in the fabrics which can be removed by treating it with hydrogen peroxide or oxalic acid. Potassium permanganate is available in the form of crystals and can be easily stored in a bottle.

**Method & Use:** Make a solution of potassium permanganate in the proportion of one ounce (about 28g) of bleach with one gallon (about 4 litres) of water for cotton and linen fabrics. For animal fabrics the above solution is diluted 2 fold with water. The fabric is steeped in the bleach for few minutes, and then the excess bleach is rinsed out of fabric which has now stained with characteristic brown colour. The article is then dipped in one of the following solution until the brown stain due to bleach is removed.

- Sodium hydrosulphite
- Oxalic acid solution (28g in 4 litres of water) or
- 2% hydrogen peroxide acidified with acetic acid (1 teaspoonful of vinegar for 500ml of bleach)

The fabric must be rinsed thoroughly in water after treatment with above chemical.

### 13.2.3.Reducing bleaches

- a) Sodium hydrosulphite                      b) Sodium bisulphate      c) Sodium thio sulphate

**3.a) Sodium Hydrosulphite :** This is sold in powder form. When dissolved in water, it readily absorbs oxygen to form sodium metabisulphite. Further, sodium metabisulphite by absorbing oxygen forms sodium sulphite and sulphur dioxide. The sulphur dioxide gets oxidized to sulphuric acid and this gives out by hydrogen. Thus the removal of stain is brought about in two ways. First the powder takes away oxygen from the stain, thus breaking up the colouring matter and secondly, hydrogen given off by sulphuric acid, removes the broken up components of the colouring matter. It can be safely used for all kinds of fabrics with the precaution that the temperature of the solution is suited to the fabrics.

**Application:** For bleaching in solution, the fabrics are steeped for few minutes in solution of 1 to 4 teaspoonfuls of the chemical in 1 pint (about 500ml) of hot or boiling water. The concentration of solution varies according to the resistance of stain and the nature of fabric. The fabrics then should be rinsed thoroughly in water containing high concentration of soap.

**Uses:** The bleach can be used in spotting treatment for many stains due to grass, dung, boot polish, mildew, ink, potassium permanganate and dye stains.

The bleach can also be used for coloured clothes. In such cases, sometimes bleach may accidentally run into the colour to change it. Immediately dipping into an alkaline solution or immediate application of soap may rectify this problem.

**Precautions:** The bleach is sensitive to decomposition by moisture, heat and oxygen. Sometimes, it may catch fire. Therefore, it must be stored in air tight, moisture free containers. The bleaching work must be done in the open or near the window to let the released sulphur dioxide escape, which otherwise may cause irritation to throat and lungs.

Further care must be taken during use in avoiding the contact of bleach with metal parts, as it may cause black stain on all fabrics. Vessels of wood or earthenware only should be used.

**3.b) Sodium bisulphite :** This is very mild reducing agent and is obtained by the partial neutralization of 'sulphuric acid' with 'caustic soda'.

The bleaching effect of this chemical is due to release of sulphur dioxide which reduces the stain by removing oxygen, to discolour it.

**Ingredients:** Sodium bisulphite - 2 tsp.  
Water - 1 pint (about 500 ml)

The solution is obtained by mixing the two components.

**Application:** The stained part of fabric dipped in the bleach until the colour is removed. Therefore, it is thoroughly washed to remove residual chemical and air dried. The last step is essential as any residual sulphur dioxide may absorb atmospheric air to form sulphur trioxide which with water forms sulphuric acid.

**3.c) Sodium thiosulphate :** This chemical is also a reducing agent which acts through liberation of sulphur dioxide. For bleaching of cotton fabric, hyposolution is obtained by dissolving one ounce (about 28g) of sodium thiosulphate and ½ ounce of 36% acetic acid in 8 quarts (about 8 litres) of water. The fabrics are then treated as with sodium bisulphite bleach.

#### 13.2.4. Optical bleaches

Optical bleaches are used for white fabrics. These are fluorescent white compounds not true bleaches. Eg. Tinopal . These compounds do not readily bleach but give a white effect. These fluorescent white compounds are absorbed by the fibre and exit a bluish appearance that covers up yellow things the fluorescent colourless dyes convert the invisible ultra-violet rays to visible light.

#### 13.2.5. Over bleaching

The overbleaching of cotton and linen fabrics is one of the main cause of general weakness of the fabrics. The fibres become brittle and harsh and give a distinct 'crackle' when rubbed together.

To overcome this problem, following precautions should be used during all beaching operations:

- (i) Use bleach of known strength.
- (ii) Keep temperature below 60°C
- (iii) Always measure quantity of bleach accurately, and
- (iv) Always dilute bleach and add gradually.

In most cases, over-bleaching is due to chlorine bleaches, but oxidizing agents do have the same effect on cotton and linen. Chlorine bleach should never be applied at temperature exceeding 160°F (71°C).

#### 13.2.6. Additional Reagents

In addition to soaps and other supplies, certain chemicals and materials are frequently used in laundries for specific purposes. These can be categorized under following groups:

- a) Alkaline reagents
- b) Acidic reagents
- c) Organic solvents, and
- d) Absorbents

##### 2.6.a) Alkaline Reagents

**(i) Ammonia (Ammonium Hydroxide or Liquor Ammonia):** This is a strong alkali and is used for removing greasy stains and scorching on animal fabrics (Solution of 1 to 4 tsp in 500 ml of warm water is used); removing smell of Jevelle water; neutralization of remaining acids in fabrics.

However, this chemical causes yellowing of silk and wool, bleaching of colours and tendering of the fabrics, if concentrations, higher than recommended are used. Concentrated ammonia is highly volatile, release high amounts of ammonia gas which causes suffocation and a choking sensations due to its pungent smell. Therefore, either diluted ammonia solution be first prepared or household ammonia be purchased for use. In the period of non-use both concentrated as well as diluted ammonia solution should always be stored in refrigerator.

**(ii) Washing Soda (Sodium Carbonate) :** This is a most commonly used chemical in laundry work. It is marketed in crystal form which dissolves easily in boiling water. It is often used with soaps to improve their detergent power. The chemical is used for many other purposes such as softening of hard water, neutralization of acids, removal of acid stains from bleached cotton and linen fabrics and emulsification of grease. In addition to the above, washing soda is also used for removal of vegetable stains and, scorching. For this purpose one to four teaspoons of chemical is dissolved in about 500ml boiling

water. The fabric is then treated with this solution when hot, for about 15 minutes and then rinsed in plain water.

Besides the above useful qualities, washing soda sometimes becomes undesirable as it causes yellowing of white fabrics. Further, it is also injurious to skin and hence care should be taken to avoid direct contact of hands, during washing of fabrics for long periods.

**(iii) Borax (Sodium Tetraborate) :** It is a mild alkaline chemical, soluble in cold water. It can be used on all the fibre types. In market, it is available as white crystal-line granules.

**Uses:** It is used to neutralize acids after stain removal.

It has a bleaching action on cotton and linen fabrics which are yellowed due to repeated washings. Such fabrics are whitened by boiling in solution of borax.

Presence of borax in starch prevents the 'scorching' or 'browning' of starch at high temperatures, used in finishing collars.

### 2.6.b) Acetic Reagents

**(i) Acetic acid:** The household form of acetic acid is vinegar (about 6% acetic acid). It is available in market in various strengths. Glacial acetic acid is the purest and strongest of all. The acid should not be used in metal vessels, but only in glass, plastic, enameled or earthenware vessels.

**Uses:** A weak solution of vinegar (2 teaspoonful in one litre water) is used as a steeping bath to remove over-bluing and as a neutralizing agent.

After washing the fabric, a final rinse in weak acetic acid solution, in addition to fixation of colour also gives an added brightness to the colours.

Rinsing in weak solution of acetic acid retains the original finish of the fabrics made from silk and rayon.

Acetic acid effectively substitutes stronger sulphuric acid used in dyeing of silk.

It helps in correction of finishing faults on cellulose acetate. If cellulose acetate fabrics are finished at too high a temperature, shiny glazed marks are produced on the fabric, which can be mistaken for grease marks. This defect can be removed by immersing the fabric in cold 20% acetic acid solution for about one hour, after which the article without water is wrapped in a cloth and the solution is extracted lightly. Then drying is carried out at about 140°F (60°C).

**Precautions:** Too much acetic acid may harm wool or silk as these fabrics have high affinity for acids. During subsequent washing, if excess acids not rinsed off, it will split a soap solution to give the fabric a greasy appearance, with a foul smell of fatty acids.

**(ii) Oxalic acid:** It is highly toxic and is marketed as white crystals.

**Use:** It is used,

- To remove iron mould and fruit stain,
- To bleach the brown stain due to potassium permanganate,
- To remove tannin-base of writing ink, in combination with hydrogen peroxide, and
- As a cleanser for white straw-hats.

For removing the stains, the article is soaked for about ten minutes in a hot solution of 1 to 4 teaspoonfuls of oxalic acid dissolved in about 500ml of water. It is then thoroughly washed. Then ammonia (100%) or borax is added to neutralize the excess acid.

**Precautions :** It must not be used on wool or silk as it causes permanent brown stains on such fabrics.

Care must be taken not to treat the article at too high a temperature (not over 140°F, 60°C) or with too strong a solution and chemical must not be allowed to dry in article, as any of the above may weaken the fabric.

Wooden spoons must be used for handling the chemical.

**(iii) Oleic acid (Olein) :** This belongs to class of fatty acids and forms soap when reacted with an alkali.

**Uses:** It is used for spotting of grease and oil stains. Oleic acid is applied to the stain and allowed to react for about 15 minutes or till the spot is dissolved. The part being treated is squeezed followed by dipping in weak solution of ammonia, which produces the soap. The stain is then rubbed or brushed until it is removed by the lather.

This acid is used to treat cotton and linen. It readily melts wool, tends to discolour silk and is unsuitable for coloured fabrics. It must always be rinsed well from the fabrics, otherwise a rancid odour will develop.

### **2.6.c) Organic Solvents:**

Specific organic solvents can be applied to most of the fabrics either to remove stains or to “Dry clean”. They do not harm the fibre or their colour. However, because of high cost, these are not used at home. Some of the most important solvents used in laundries are described below:

**(i) Cleaning benzene (Petrol) :** This is obtained by distillation of petroleum and is highly inflammable. It should never be stored in large quantities indoor or be used near fire.

**Use:** It is used for spotting of grease stains and dry-cleaning.

**(ii) Carbon tetra-chloride :** It has action similar to that of petrol, but is more expensive. However, it has the advantage of being non-inflammable, but is highly toxic. Therefore, it should be worked with either in open or near open window, as it is extremely volatile.

**Uses:** It is solvent which can be used on all fabrics for removal of paint and grease stains.

**(iii) Acetone :** It is very useful solvent for treating many stains. However, it is highly inflammable and also cannot be used for cellulose acetate rayon which is rapidly dissolved in this solvent.

**Uses:** On fibres, other than cellulose acetate and vinyon, acetone can be effectively applied to remove stains due to paint, nail polish, lipstick, varnish and shoe polish etc.

**(iv) Methylated spirit (alcohol) :** It is alcohol which is artificially coloured and toxified by addition of methyl alcohol, to make it unsafe to drink.

**Uses:** It is used for removing sealing wax, silver nitrate and other silver stains, but it is not a very effective solvent for organic stains. Its usefulness increases when employed along with soap. Alcohol dissolves acetate rayon, but can be used safely on all other fabrics.



(v) **Paraffin** : This is wax which is a by-product of petroleum refineries.

**Uses:** It is used in removing grease and paint stains on rubber fittings in laundry appliance.

(vi) **Turpentine** : This is more expensive than paraffin and possesses a distinctive smell. It is inflammable and volatile.

**Uses:** It is used to destain the fabric spots due to grease, paint, varnish and printer's ink. It can be safely used on all fabrics including acetate and nylon.

#### **2.6.d) Absorbents**

Several absorbents are used in home and in laundries for removal of grease spots from all fabrics as well as for general treatment of light coloured fabrics that are evenly soiled. These can also be used for articles like, furs, and dark coloured gloves which cannot be cleaned by solvents alone. Examples are French chalk, common-salt, bran, fuller's earth, bread-crumbs, powdered magnesia and other commercial dry-cleaning powders.

**Application:** To remove the stain or in general cleaning, first of all, brush off the loose dirt from the article and then spread absorbent. Rub it lightly in a circular motion and let it remain for half an hour. Then shake the powder and brush the whole garment.

Bran, moong powder and bread-crumbs are used after light warming. They are useful for cleaning dark-coloured felts, furs, camel-hair cloth and greasy soiled sarees.

**Use:** The absorbents are used for cleaning grease marks on both light and dark coloured fabric of all kinds, white laces, fur, coats, shawls and felt hats. These do not harm the fabrics in any way.

### **13.3. STARCHING**

Starches make clothes stiffer, crisper and shinier or glossy surface, which is resistant to dirt and dust.

Starch is by far the most frequently used stiffening agent, which consists of carbon, hydrogen and oxygen and is similar to sugar in composition. Starch is manufactured by plants. There are two general types of starch. Vegetable (made of white vegetables and corn mixture) and plastic (made of resin). The plastic type is of comparatively recent origin and is sometimes considered a starch substitute.

Suitable starches are stored by nature in the stems of certain plants Eg., (Palms) but more often in grains or seeds (Eg. Rice, wheat, maize etc) and in roots and tubers such as potatoes. Sweet potatoes, arrow root etc. starch is a carbohydrate and the physical appearance of the starch from all these different sources is very much the same, even chemical tests are not helpful, only a microscopic examination of the grains reveals the fact that they differ in shape and size.

**13.3.1. Rice starch:** These starch grains are the smallest and make a viscous solution which is suitable for stiffening the fabrics with pliability. This starch is suitable for cold water starching if the size of the grains is small enough to effect an easy penetration into the fabric.

**13.3.2. Wheat:** The starch grains are large and small sizes, give a strong viscous solution which produces stiffness with pliability in the fabric. But it is very expensive and so it is not economically useable in laundry work.

**13.3.3. Maize:** This starch gives viscous solution but produces undesirable stiffness which feels rough to the touch. It is cheap and may be used after blending with other starches.

**13.3.4. Potato:** These starch grains are very big and so it is not suitable for laundry work as commercial starches. Various brands of commercial starches are available, usually manufactured by blending two or three different kinds. The chief advantage of these synthetic starches gives a stiffening which lasts even after the fabrics are washed several times.

### **13.3.5. Starch substitutes or Extenders**

The shortage of starch has given rise to a variety of products which are claimed to be starch extenders or starch substitutes. Eg. Calcium alginate & barium sulphate as a paste, possible to obtain the same amount of stiffness with less starch.

In Malabar and south west coast of India polished tapioca powder and tamarind seed powder are blended with some commercial starches.

### **13.3.6. Boiling water Starch**

When starch is cooked in water the granules swell and become almost clear. The degree of cohesiveness depends upon the kind of raw starch used.

#### **Recipe for starch jelly,**

- 1 tablespoon starch
- ¼ teaspoonful of borax
- 2 tablespoon cold water
- 1 part boiling water

**Method of preparation :** Mix the starch to smooth paste with cold water, pour over boiling water, stir until the appearance of transparent liquid and must be diluted at once by adding an equal quantity of hot water. A little formalin can be added to prevent the starch stain becoming sour.

**Use:** For cotton and linen, starching process is simple. The articles are dipped up and down in the starch solution till they are thoroughly saturated, wring out and put to dry. The strength of starch required for various kinds of articles depends on,

- 1) The thickness of the fabric
- 2) The stiffness required in the fabric and
- 3) Personal taste

### **13.3.7. Cold Water Starch**

#### **Recipe:**

- 1 teaspoon rice starch
- ½ teaspoon borax to give more stiffness
- 3 drops turpentine (instead of wax)
- ½ part cold water
- 1 teaspoon boiling water

**Method:** Dissolve the borax in boiling water. Add cold water and turpentine. Mix to a smooth paste. Strain through muslin, cover and leave for half an hour before use, to soften the starch grain.

**Use:** This starch is employed where greater stiffness is required. The material must be dry for this type of starching. The starch mixture is absorbed in to the mesh of the fabric, squeeze out. Rub off surface starch grains with a muslin wring out tightly in cold water. Iron with a quick movement.

### 13.3.8. Laundry Blues

White fabrics often lose their original, sparkling whiteness and develop a yellow tint. This tint may be due to one of the following causes:

1. Incomplete washing.
2. The deposition of lime or iron particles from soap on fabrics.
3. The reappearance of the natural colouring of the original fibres after repeated washes in which no bleach has been used, or the effect of coarse alkaline soap upon fabrics damaged by over bleaching.

Contrary to belief, bleaching does not whiten clothes; it merely corrects the yellow ting that clothes may develop owing to one of the above – mentioned reasons.

Blues are chemicals used during the wash cycle, either at home or by large laundries to correct the yellowing of white fabrics. Ultramarine is a commonly used household blue. It is insoluble in water.

**Most laundries use soluble blues:** Ultramarine is a safe blue to use. It is not affected by alkaline soaps. it is sometimes used together with soap in boiling water so that the blue is ‘boiled in’. Blueing with ultramarine may, however, cause trouble by large particles forming streaks on the fabric. This may be avoided by applying the blue before the last rinse. The care required with ultramarine has caused the abundant of its use by many laundries in favour of the soluble blues and fluorescent washing powders, which are simpler to use.

The soluble blues are actually aniline dyes and are marketed in a great variety. They are easy to prepare, control and apply, producing an even colour and leaving no sediment. They are widely employed in large-scale power laundries. These can be obtained as concentrated solutions or as powders. Purplish-blue is the most popular shade, as it gives a whitish appearance. The aniline dyes have a strong affinity for materials and must be used with care. However, owing to their high solubility, they are easily removed by thorough rinsing, so that correction of over-blueing is no trouble.

Blueing must only be done when the fabric is free from soap. The process, therefore, follows the last or second last rinse. The blue is tied in a piece of muslin and squeezed in cold water until the required depth of colour is obtained. Ultramarine, being insoluble, is held in suspension; so the water must be stirred each time before use.

The article is dipped up and down in the solution once or twice. Any water retained in pockets or other bagshaped parts is shaken out. The articles should be moved constantly, and not allowed to rest in the bath. Blueing and starching may be combined if necessary.

Yellow articles should be blueed, since they turn greenish. Over blueing can be removed by treatment with acetic acid. It should be noted that blueing is not really necessary in India, where there is strong sunlight for nine months of the year. Sunlight is the best natural bleach for properly washed articles.

## 13.4. DRYING AND PRESSING

**13.4.1. Drying:** The old fashioned method of drying was to remove excess water by hand wringing followed by laying the goods flat in the sun or hanging them on a line. In today's automatic washing machines excess water is removed automatically. Clothes should be taken from the dryer to avoid wrinkling, stiffness or shrinkage. If an item is to be dried on a line, the line should be wiped clean, clothes should be shaken and smoothed out as they are hung, all seams should be straightened and removed from the line before they are fully dry in order to avoid dampening and insure ease in ironing.

### 1.1. Drying equipment

**1.1.a) Outdoor drying:** Clothes cord, cotton, hemp or coconut rope or galvanized wire, either solid or twisted may be used as clothes line. The wire lines are more permanent, they must be wiped of with damp cloth before being used and must be free from rust. The best place to dry clothes is out of doors in clean air and sunshine.

### 1.1.b) Indoor driers

When outdoor drying is out of question, or in long monsoon, same provision must be made for indoor drying.

- a). A good drying rack for a small home is a wooden frame equipped with rope and pulleys that will hold it up to the ceiling. Long thin bamboos are often used in most homes.
- b). A folded rack which can be easily made will be useful.
- c). A heated drying cabinet is a boon for drying clothes where during the monsoon weather outdoor drying is not possible with most cabinets the heat is adjustable – one temperature for drying and the other for arising. In large modern hotels or institutions a drying cabinet heated by gas or electricity is sometimes provided.

Outdoor drying is best for all white articles as sunlight helps to bleach the cloth, quickens the drying, disinfects and freshens the clothes. Articles should hang out on a line by the selvedge thread and then clipped to the line with wooden clips. They should not be left out in the sun too long but removed as soon as they are dry.

Indoor drying is best suited for coloured articles, to preserve the fastness of the colour.

### 13.4.2. Pressing and Ironing:

Most articles needed some pressing after cleaning to restore them to their original appearance. Finishing is the process used to straighten the clothes, so that the appearance is attractive and neat.

#### 2.1. The methods used for finishing the laundry are,

- a) Ironing      b) Pressing      c) Steaming      d) Mangling      e) Calendaring.

**a) Ironing:** This process consists of running a hot iron backward and forward along the selvedge threads of the cloth with pressure. The heat of the iron and the pressure applied is controlled according to the texture and the nature of the fabric.

## **Method of Ironing**

1. Essentials for good Ironing are a hard padded surface and a clean hot iron.
2. For saris and sheets use a table 4 x 2½ ft. and about 3 ft high. For other articles use an ironing board. Have a bowl of water, a piece of muslin and an iron stand.
3. Open out the damped article, stretch it and iron by running the hot iron backward and forward on the selvedge threads.

**b). Pressing:** This process consists of placing and then lifting it up. It is not a continuous running of the iron to and fro on the surface of the cloth.

**c). Steaming:** This process consists of allowing the steam to pass through the surface of the cloth. Fabrics with pile surface such as velvet and velceteen are finished by this process.

**d). Mangling:** Is used only in cases of rough articles, where the surface is expected to be neat but not very smooth.

**e). Calendaring:** Used in commercial laundries to finish straight pieces of cotton and linen articles such as table clothes, curtains and bed sheets. The articles are passed through two heated metal rollers which continuously rotate.

## **2.2. Irons**

Various types of irons are now available, heated by charcoal or electricity.

**a) Charcoal Iron:** Is the most commonly used iron commercially.

**b) Electric irons:** Non-automatic, automatic and steam irons.

The modern automatic electric iron has a dial by which one may select the amount of heat needed. In general silk and manmade fibers needed low heat, while cottons and linens require highest heat. If the right heat is dialed clothes will not be scorched and wrinkles will come out.

## **13.5. STORAGE OF CLOTHES**

Clothes require care not only during their use but also while they are stored. The weather is not the same all the year round, hence the need for specific fabrics for specific weather conditions necessitates the storage of clothes not needed at the particular time. If large number of clothes are there, a small room or store can be used for the purpose, otherwise a cupboard or a shelf can also be used.

### **13.5.1. A good storage space should have certain desirable features.**

- a). It should be clear, dry and free of humidity.
- b). It should be well lighted and not very dark.
- c). The shelves should be in plenty and smooth. These should not be too high because it becomes difficult to store the clothes.
- d). The shelves should be deep.
- e). They should be covered with paper.
- f). Drawers can also be used to store clothes and are safer as compared to shelves.

- g). If a cupboard is used, the door should be properly closed.
- h). The storage space should be dry, insect free and away from dust and dirt.

### **13.5.2. Considerations or steps while storing clothes**

- a). The clothes must be dust free. They must be brushed, pocket must be emptied, and exposed to sun before storing.
- b). The garments that require washing must be washed before storing. Those require dry clean must be dry cleaned.
- c). Airing must be done in boxes or cupboard as well as clothes before putting away.
- d). Clothes must not be kept in damp condition. Moisture causes mildew which may damage the clothes. So storage must be done in dry condition.
- e). The cupboard or storage box must be lined with paper or old clean cloth sheet.
- f). The storage space must be sprayed or dusted with an insecticide to prevent damage from insect, moths etc.
- g). Repellents such as tobacco, dried neem leaves etc. can be used in the storage. Napthalene balls and Odonil etc. are quite effective. Even camphor is considered to be useful.
- h). Newspaper can be used for wrapping woolens as moths dislike printing ink.
- i). Fumigation (smoke) with poisonous gas like hydrocyanide is also useful. Though it kills moths, it is very dangerous and requires special handling. This is done on large scale.
- j). Clothes must be packed up tightly in one area for example coats, over-coats at one place, cardigans and pullovers at one place, sarees at different place etc.
- k). New white cloth must be wrapped up so as to avoid yellowing, if they are to be stored for long time.
- l). If clothes are to be stored for long time, one must keep changing their folds as some clothes can crack at folds.
- m). It is better to pack each article of clothing in polythene bags separately before storing.
- n). Never store starched clothes for a long time.
- o). Store sparingly used articles in on topmost shelves. Place very heavy ones in the lowest shelves, for comfort in handling them.
- p). Drawers can be placed in sunlight occasionally to remove moisture and all insects.
- q). Soiled clothing items must never be stored, for it has many disadvantages. The stains may become set and permanent it is more easily attacked by moths, insects and mildew.
- r). Mend all tears before storing to prevent it from getting larger.

### **CONCLUSION**

Proper care and maintenance of clothing adds beauty to the wearer and prolongs the life of clothing.

## QUESTIONS

### I Choose the correct answers

1. Laundering requires patience and practice to learn the \_\_\_\_\_ Techniques  
a) Light            b) easy            c) right            d) simple
2. The \_\_\_\_\_ dirt is removed by steeping and mechanical means  
a) grease            b) fixed            c) loose            d) vegetable
3. Kneading and squeezing is best suited for \_\_\_\_\_ fabrics.  
a) lightly soiled    b) heavily soiled    c) delicate        d) coarse
4. Heavily soiled garments have some \_\_\_\_\_ rubbed in before being placed in the machine  
a) water            b) alkali            c) soap            d) bleach
5. Dry the \_\_\_\_\_ items in the direct sun light  
a) coloured        b) white            c) heavy            d) none of the above
6. \_\_\_\_\_ is a complex process of removing discoloured matter from fabrics.  
a) Washing        b) Bleaching        c) Starching        d) blueing
7. The natural bleaching agent is \_\_\_\_\_  
a) Air                b) Sunlight        c) Soil                d) Gas
8. The \_\_\_\_\_ bleach is used as an antiseptic and a deodorant  
a) Chlorine        b) Borax            c) Hydrogen peroxide    (d) Sodium perborate.
9. The \_\_\_\_\_ bleaches are fluorescent white compounds not true bleaches.  
a) Optical brightness b) chlorine    c) Potassium permanganate d) Sodium perborate
10. The \_\_\_\_\_ starch produces undesirable stiffness which feels rough.  
a) rice                b) potato            c) maize                d) wheat
11. The potato starch grains are very \_\_\_\_\_ So not suitable for laundry work.  
a) big                b) small            c) transparent        d) opaque
12. The degree of \_\_\_\_\_ depends upon the kind of raw starch used.  
a) Cohesiveness    b) consistency    c) thickness            d) quality
13. Indoor drying is best suited for \_\_\_\_\_ garments  
a) Coloured            b) light weight        c) heavy                d) bulky

### II. Write short answer

1. Define washing and fabric softeners?
2. What is kneading and squeezing
3. List the methods in friction washing.

4. Define the terms.
  - 1) Bleaching
  - 2) Oxidizing bleaches
  - 3) Reducing bleaches
  - 4) Optical brighteners
5. Give the composition of starch.
6. State the purpose of starching process.
7. Mention the advantage of synthetic starch.
8. State the purpose of pressing.
9. List the type of clothes cords available.
10. What is the purpose of drying cabinet?

### **III. Give brief answers**

1. Discuss the advantages and disadvantages of hand washing method.
2. Enlist the guidelines for hand laundering
3. What are the precautions to be observed while using washing machine?
4. Describe the general procedure for using automatic washing machine?
5. List the oxidizing and reducing bleaches and explain any one.
6. Discuss any two dry cleaning agents.
7. Enlist the advantages of Hydrogen peroxide bleach.
8. How will you classify starch. Give example.
9. Give a note on laundry blues.
10. Explain the method of preparation of starch jelly.
11. Write notes on Indoor and outdoor drying methods.
12. Give a note on steps to be followed for storing clothing items?
13. Explain the method of Ironing garments.

### **IV. Give detailed answers**

1. Give a detailed account on principles of washing and their applications.
2. Enumerate the merits and demerits of hand and machine washing.
3. Give an account of role of bleaching agents in laundry work.
4. Describe in detail the additional reagents used in laundry work.
5. Discuss the role of starches in laundry work.
6. Write detailed notes on blues used in laundry work.
7. Give a detailed account on drying and pressing processes.
8. Enumerate the points to be considered while storing clothes.



# 14. APPAREL MERCHANDISING

## INTRODUCTION

Apparel merchandising attempts to the structural changes in the textile industry, focusing on the export of textiles and garments. The textile industry employs several mode of production. Apparel merchandising refers to the techniques used to sell products to consumers. A merchandiser is someone who purchases a product from a manufacturer, and then sells it to shoppers. There are numerous techniques that a merchandiser may use to convince shoppers to buy the products, he or she is selling. It is usually more than just setting products on a shelf and hoping that they are purchased.

An apparel merchandiser, also known as a fashion merchandiser, is the person who conceives and implements merchandising, displays in retail environments focused on the sales of clothing and accessories. She may dress mannequins, create fashion-focused scenes in store windows and design promotional graphics for in-store promotions.

### 14.1 DEFINITION

Generally, Merchandising is planning, developing and presenting product lines for identified target markets, with regard to pricing, assortment, styling and timing. Merchandisers may be involved in the apparel-manufacturing and retailing levels of the apparel business. Merchandising is the central coordinating point for the product line.

- Precise: Merchandising is defined as the planning and promotion of sales by presenting a product to the right market at the proper time, by carrying out organized, skillful advertising, using attractive displays, etc.,

### 14.2 FUNDAMENTALS OF TECHNOLOGY FOR APPAREL MANUFACTURING

Traditionally, the textile-apparel industry is horizontally structured with the manufacture of cloth not distinct. The flow sequence begins with fibre producers supplying raw materials to yarn manufacturing plants, and then to weaving and knitting facilities. Manufactured fabric is then sold to the fabric finisher, and then to the garment manufacturer.

Today, the textiles and apparel market is increasingly global, operating in a highly competitive spirit, requiring specialization and targeting market niches. The industry has restructured from one of the many small firms to one of the few large integrated firms. More significant is the array of new production and control technologies, controlled through a 'quick response' network that effectively reduces the distance between producers and retailers. Industry trade groups see technological advancements, as the key to increased competitiveness in the global marketplace.

According to the Standard Industrial Classification, textile has nine separate textile mill products sub sectors (three-digit) and twenty three market segments (four-digit) defined by broad product categories. Each of the 6,134 textile establishments operating in the United States was placed in one of these nine industry sub sectors.

They are the following:

- i. Broad woven fabric mills, cotton.
- ii. Broad woven fabric mills, manmade fibre and silk.

- iii. Broad woven fabric mills, wool, including dyeing and finishing.
- iv. Narrow fabric and other small wares mills: cotton, wool, silk, and manmade fibre.
- v. Knitting mills including knit women's full-length and knee-length hosiery, socks, outerwear, underwear and nightwear, weft (circular) fabrics, lace and warp (flat) knit fabrics, and knitting gloves and other.
- vi. Dyeing and finishing textiles, except wool fabrics and knit goods including finishers of cotton broad woven fabrics and finishers of broad woven fabrics of manmade fibre and silk.
- vii. Carpets and rugs.
- viii. Yarn and thread mills.
- ix. Miscellaneous textile mills including non-rubberized coated fabrics, tire cord and fabrics, non-woven fabrics, cordage and twine, and other textile goods such as linen, jute, felt, padding and upholstery filling and processed waste and recovered fibres.

According to the Standard Industrial Classifications, apparel has nine separate apparel and other finished products sub sectors and 31 market segments defined by broad product categories.

The eight apparel categories are the following:

- Men's and boy's suits, coats, and overcoats.
- Men's and boy's furnishings, work clothing, and allied garments including shirts, underwear and nightwear, neckwear, trousers, pants, and work clothing.
- Women's, misses' and juniors' outerwear including blouses, dresses, suits and skirts.
- Women's, misses', children's, and infants' undergarments including underwear, nightwear, bras, girdles and allied garments.
- Hats, caps, and millinery.
- Fur goods.
- Miscellaneous apparel and accessories including dress and work gloves, robes and dressing gowns, waterproof outerwear, leather and sheep clothing, apparel belts, suspenders, garters, handkerchiefs, and other apparel.
- Miscellaneous fabricated textile products including curtains and draperies, house furnishings, textile bags, canvases and related products, pleating and decorative stitching, automotive trimmings, schiffli machine embroideries, and other fabricated textile products.

### **14.3 VISUAL MERCHANDISING**

Visual merchandising is the activity of promoting the sale of goods, especially by its presentation in retail outlets. The above sentence is taken from the reference in "The New Oxford Dictionary of English, 1999, Oxford University Press". This includes combining products, environments, and spaces into a stimulating and engaging display to encourage the sale of a product or service. It has become such an important element in retailing that a team effort involving the senior management, architects, merchandising managers, buyers, the visual merchandising directors, designers, and staff is needed.

### **14.3.1 Basics of Visual Merchandising**

Visual merchandising is creating visual displays and arranging merchandise assortments within a store to improve the layout and presentation, and to increase traffic and sales.

As an example, mannequins are commonly used, as a way to promote products relating to appearance, such as clothing or accessories.

- Mannequin dress forms for generating visual displays.

### **14.3.2. The scope**

Visual merchandising may include all or some of the elements outlined below:

- Choice of fixtures and fittings to be used.
- Method of product presentation.
- Construction of 'off-shelf' displays.
- Choice of store layout (to encourage complementary purchases).
- Use of point of sale materials (to encourage impulse purchases).
- Construction of window displays.

### **14.3.3. Fixtures and Fittings**

The way products need to be presented and displayed within the store, will largely determine the choice of fixturing.

### **14.3.4. Product Presentation**

The way in which products are presented as routine, will depend on the types of fixtures available but essentially can be visual merchandising

- Vertical stacking, for example, for magazines or CDs.
- Horizontal stacking, for example, for tinned foods or folded garments.
- Hanging – on hangers or hooks.
- Hanging – mounted on card or bubble packed.

### **14.3.5 STORE LAYOUT**

Visual merchandising also encompasses the design of a store layout. A store layout will be heavily influenced by the assortment and variety on offer and will be constrained by the size and structure of the shop itself. The layout will also determine or be dependent on the type of fixturing used. There are a number of different approaches to store layout, although they are all designed with the intention of moving customers to every area in the store in order to expose them to the full range of products.

### **14.3.6 Off-Shelf displays**

These displays are designed to have additional impact by showing the product as it might be used, or perhaps alongside with other products to suggest, complementary purchases. Displays can also be considered as visual features that create interest or excitement within the store.

### **14.3.7 Window displays**

Window displays have a particularly important role to play in communicating to the potential customer, what the retailer stands for, in terms of product and shopping environment. Window displays make customers aware of the type of merchandise being sold, and hopefully will attract the interest of target customers.

A retailer's window is the most controllable element in relation to image and must match its merchandise's target, demographically. Display windows may communicate style, content, and price point. They can be seductive, exciting or based on emotional stimulus through stimulation, or evocation of all five senses. Another direction taken by retailers who rely on volume sold is price-based selling. These clearly emphasize the value for money with easy and obvious ticketing.

The best store window can generate great excitement and are a talking point. They contribute to the environment by entertaining pedestrians, while simultaneously communicating the products and service an offer.

For, a retailer willing to exploit the full potential, that a window gives, the image-building process can be exciting and have enormous potential. A fashion retailer, for instance, will often change a window weekly to show the latest items on offer. A glance into a shop's window, by a passerby, establishes the time of the year, and, very likely, a timely contemporary event. It might combine seasonal and festive points of the year such as Back-to-school, Spring, Summer, Easter, Christmas, New Year approaching, Diwali, Valentine's Day, Mother's Day etc. At other times the propping may be based on colour schemes, materials or cultural themes.

## **14.4 FASHION MERCHANDISING**

Fashion merchandising is the promotion of apparel sales and involves all tasks necessary to deliver the clothing on request and meet the needs of potential customers and designers. Developing campaigns, displays and advertisements, directing, manufacturing and marketing, and creating sales strategies, are all part of the inside game. Fashion merchandising also refers to the necessary preparation that must be done in order to ensure, that the merchandise is accessible and appealing to the customers it is intended for.

Fashion marketing and fashion merchandising go hand-in-hand. Fashion merchandising must also be able to predict styles and trends and evaluate the needs of a target market. The fashion marketer identifies such needs in order to build more successful advertising campaigns, to attract consumers. However, the fashion merchandiser is responsible for actually buying the clothes and presenting them in the stores.

Fashion merchandisers must also be very creative and possess forward thinking. One of the jobs of a fashion merchandiser is 'Visual Merchandising'. Fashion merchandising requires a blend of fashion sense and business expertise.

### **14.4.1 Seasonal fashion merchandising**

Seasonal fashion merchandising refers to the process of merchandising that is the management of products and stocks according to the seasonal trends or fashion prevailing in the market. Seasonal fashion merchandising is fast becoming the mantra in the Indian retail scenario.

Seasonal fashion merchandising has its own benefits as well as limitations. The following points analyse the concept as a whole:

#### **14.4.2 Accurate forecasting**

In order to generate more sales through seasonal forecasting, it is necessary to be able to forecast the market trends accurately.

#### **14.4.3 Timeliness**

Timeliness is the key to successful seasonal merchandising, while deciding to stock a particular product, and bringing a trend earlier than its time. At the same time, it is needed to ensure that there is no stocking of an outdated item.

#### **14.4.4 Customer base**

While undertaking seasonal merchandising, the merchandiser has a fair idea of what customers each type of seasonal product would attract. Sometimes, products that are in fashion might attract only a specific class of customers, while some other products might attract a large number of customers. This gives an idea of how much the product should be stocked and also how overstocking and under stocking could be avoided.

#### **14.4.5 Managing risks**

You should have well-planned strategies for risk management, in order to make seasonal merchandising successful. In the case of overstocking, you should take into account ways for stock clearance, discounts and exploring other potential markets. Some retailers have well-defined sections, such as core products and seasonal products. Core products are the basic or classic products offered by the retailer, while seasonal products are those that are currently in fashion.

#### **14.4.6 Apparel quality management**

Quality does not always means spending a lot of money. Many manufacturers and retailers add these 'quality details' on apparel at numerous price levels.

Always remember, quality can be found at any price level.

- Fabric is the basic foundation of apparel. Fabric is woven by yarns, which run up-and-down, or across. When apparel is cut from the fabric, it should run up-and-down and across too. Sometimes if the apparel is not cut correctly it actually causes clothing to twist around the body. This is called off-grain, and cannot be corrected.
- Manufacturers sometimes use bias cut sections to cut costs. Bias cut apparel, is exceptionally difficult to sew, and tends to stretch out of shape, or hang unevenly at the hem, or sag, comprising quality.
- Patterned fabrics should match along seam lines in both directions, across and up-and-down. Matching indicates quality because of the additional fabric and labour involved in cutting and sewing.
- Colours should match between pieces and is an indicator of quality. Fabric, thread, buttons, zippers and even elastic, should match, function and be durable.

- Seams within a garment should be securely sewn. Check to make sure threads have not popped or ruptured along all seams.
- Design features within apparel can also help you judge the quality.
- Collars should be smooth as they lay against the body.
- Sleeves need to be of sufficient width so that the arm can comfortably move, and the sleeves must be long enough to cover the wrist when bent.
- Waistlines or waistbands should appear smooth and even around the body. Fold lines along the waistband, indicates the band is too small for the wearer.
- Hems should appear without puckers along with the garment, of even width around the garment, and be inconspicuous from the front side.
- Closures such as buttons, zippers, and hook-and-loop tape should function and be durable. Closures should not “gap” when worn.
- Fit of the garment to the wearer is the final indicator of a quality decision. Alterations if needed can be an additional expense, be sure to check the fit by sitting, walking and bending with the garment on the body.

#### **14.4.7 Nature and timing of merchandising product**

Merchandising processes differ for individual firms according to business strategies, product types and technologies employed. Merchandisers in small firms may be responsible for planning the line, and developing it, and presenting it at wholesale. Merchandisers in large firms may be responsible primarily for planning the line, while the design staff carries outline development.

The primary components of merchandising activities include line planning, line development and line presentation.

Line planning is the formulation of the parameters, the guideline, and development, and presentation and influences sourcing and production processes. Line planning has subcategories, including evaluating merchandise mix, forecasting merchandise offerings, planning merchandise budgets and merchandise assortments and analysing and updating merchandise plants. The line plan defines and limits the line.

Line development has subcategories of line concept, creative design, line adoption, and technical design. Line development includes determining the actual merchandise that will fill out the line plan through some combination of product development and/or selecting finished goods at wholesale. Line development identifies merchandise that implements the line plan.

Line presentation, with subcategories of internal (meaning within a firm), wholesale (meaning through interaction at wholesale markets or with personal calls by sales representatives), and retail (including the many different retail formats and components of presentation), involves processes required to evaluate the line and make the line visible and salable. Line presentation results, in evaluation and sale of the product offering.

## **14.5 FASHION MARKETING AND MERCHANDISING**

This caption does not touched retailing or this has the following sub –divisions.

Retailing is defined as businesses primarily engaged in the final sale of tangible goods to individual, ultimate consumers and householders. Of course customer service is also an important component of merchandise retailing.

### **14.5.1 Retail growth**

We are impressed by the growth, the real growth, of retail business over the years. Retail sales have advanced substantially. Retail sales per capita are adjusted for inflation; in short the actual amount of goods purchased per ultimate consumer has grown steadily since at least 1948.

This growth occurred in spite of an increase in recent decades in the share of consumer income directed towards the purchase of services rather than goods. As already noted the census defines retailing as the business of selling goods. Any increase in the service share, will have negative effects, on the census retail sales figures.

### **14.5.2 Systemic complexity**

Not only the American retailing system has grown, larger over the years, it seems to have grown more complex. It probably contains more formats, and perhaps more variations within formats, than ever before. Although two basic forces, one external and one internal to retailing, account for these changes, they probably have conflicting implications for the future.

The external factor is the level of the economy. A high level economy will have a more elaborate pattern of goods and services than a low level one.

### **14.5.3 Single store independents**

The growth in the retail volume has had important and beneficial implications for all types of retailers. Even the so called single store ‘mom and pop’ retailer, has gained in actual volume over the years, although at a much lower rate than the multiunit chain store retailer. Consequently, single unit enterprise market share has steadily declined. But the total business has grown. Stores of this type will have to find a special location merchandise, or service niche in which to prosper.

### **14.5.4 Multinut retailing**

There are several factors that suggest, continuation of multiunit market share growth during the foreseeable future. Technological improvement facilitates the type of centralized management that characterizes these organizations. The economies of scale that results from increasing store count and the ability to divide tasks between store operations and central merchandising put them in very powerful positions vis-à-vis both their customer and their suppliers.

### **14.5.5 Costing of apparel product**

Costing is the process of estimating the total resource investment required to merchandise, produce, and market a product. Product costs accumulate from all functional divisions of a company.

Costs have a major impact on a firm’s success and thus must be managed. The key to successful cost control is information and the ability to use that information to manage a firm.

Cost of goods sold, represents all expenditures associated with the manufacture of the product line including material costs, labour costs, and factory and administrative overhead expenses.

This process consists of the following:

#### **14.5.6 Manufacturing costs**

Manufacturing costs include all the expenditures that are incurred in making a finished product available. These costs are summarized as cost of goods sold on the income statement.

Direct materials costs include fabric, thread, trim, and findings used in garments.

Direct labour costs include wages of employees who work on the product in the plant, including cutters, sewers and finishers. Direct materials and labour are direct variable costs. The cost varies with the quantity of goods produced.

Overhead costs consist of both non variable and variable indirect manufacturing costs. Overhead costs are unique to each firm, but they generally are subdivided into (1) indirect labour, (2) occupancy, and (3) other overhead. Indirect labour costs consist of service personnel, quality control, material handlers, mechanics and maintenance workers, and security. The work of these individuals is essential to efficient manufacturing of a product line. But none of them work directly on the product. Nonvariable or occupancy overhead costs include rent, depreciation, insurance, property taxes, and security. Examples of variable overhead costs are machine parts and repairs, marker papers, and needles. Other overhead costs include materials management, machinery and equipment costs, and cost of compliance with regulations.

#### **14.5.7 Stages of costing**

Managers use costing to determine (1) the product ability of a design within an established price range, (2) the profit potential in a design, and (3) whether a design should be added to the line.

Costing may be done at several different stages throughout manufacturing: (1) preliminary or precosting is done during the creative design phase of product development before samples are made; (2) cost estimation is done prior to line adoption; (3) detailed costing is done during the technical design phase prior to production; and (4) actual costs are determined during and following production.

#### **14.5.8 Preliminary costing for creative design**

Preliminary costing is a rough estimate of costs of producing a particular style. Fabric type, yardage, and quantities are estimated, as are trims and other materials costs. Labour costs are estimated based on production of similar styles.

#### **14.5.9 Cost estimating for line adoption**

Cost estimating determines the expected investment in materials, direct labour, and overhead required to produce a single unit of a style. Specific materials have been determined, and fabric yardage requirements must be refined. Labour costs are estimated based on the time required to produce a style and the average hourly wage.

### **14.6 DETAILED COSTING FOR TECHNICAL DESIGN**

Detailed costing is done after styles are adopted into the line and refined for production. It provides the opportunity to pick up any cost that may have been missed during cost estimating, such as an



overlooked label or an extra button. It also picks up changes that were made by technical designers, such as fit changes that reduced the amount of fabric needed or a complex operation that may have been simplified.

#### **14.7 DETERMINING ACTUAL COSTS**

Actual costs are determined by the collection of data from production. Once a style reaches the sewing floor, an engineer may find some rates are too tight and that more time is needed to complete specific procedures. If a rate adjustment is needed, it will inevitably affect costs. Actual costs must be monitored throughout production.

#### **CONCLUSION**

The future will undoubtedly require fewer, but better intellectually. Equipped, buying and merchandising staff backed by more and more sophisticated technology, just as the paper-based bank clerk has in large been replaced by technology. So we will be many of the buying and merchandising jobs of the future.

#### **QUESTIONS**

##### **I. Choose the correct answer**

1. Fit of the \_\_\_\_\_ to the wearer is the final indicator of a quality decision  
a) Collar                      b) Button                      c) Garment                      d) Sleeve
2. Collars should be \_\_\_\_\_ as they lay against the body  
a) Curved                      b) Smooth                      c) Circle                      d) Straight
3. \_\_\_\_\_ merchandising requires a blend of fashion sense and business expertise  
a) Apparel                      b) Visual                      c) Retail                      d) Fashion
4. The textile industry employs several mode of \_\_\_\_\_.  
a) Consumption                      b) Production                      c) Decoration                      d) Application
5. Apparel merchandising refers to the techniques used to sell products to \_\_\_\_\_.  
a) Retailers                      b) Consumers                      c) Wholesalers                      d) Manufacturer

##### **II. Write short answers**

1. Define merchandising
2. Define apparel merchandising.
3. Define visual merchandising
4. What is fashion merchandising?
5. Define retailing

##### **III. Give brief answers**

1. List some of the elements of visual merchandising.

2. Distinguish between window display and off – shelf display.
3. Write a note on window display.
4. Distinguish between direct labour cost and indirect labour cost.
5. Explain about the stages of costing

**IV Give detailed answers**

1. Explain the primary components of merchandising activities

**Answer**

I Choose the correct answer

1. c                      2. b                      3. a                      4. b                      5. b

# 15. ROLE OF COMPUTER IN GARMENT DESIGNING

## INTRODUCTION

CAD or Computer-aided design has brought a revolution in the Textile Industry. In today's world, the Textile Industry is being modernized day by day. The designs are used in different textiles manufacturing processes made in CAD. The Textile Industry, which wants to stand out from the crowd and be a renowned and a reliable one, must have the CAD system or CAD software in their manufacturing process. CAD has made the time consuming and cumbersome process of textile designing easier. Now thoughtful and innovative designs are available to the textile designers and textile manufacturers. CAD is an electronic tool that enables you to make quick and accurate drawings with the use of a computer. Unlike the traditional methods of making drawings on a drawing board, with CAD you can sit back in an easy chair and create wonderful drawings just by the click of the mouse. Moreover, drawings created with CAD have a number of advantages over drawings created on a drawing board. CAD drawings are neat, clean and highly presentable. Textile drawings can be modified quite easily and can be presented in a variety of formats.

### 15.1 CAD- WHAT IS IT?

When the products in pre-manufacturing stage are designed with the help of computer-based tools, it is termed as CAD or Computer-aided design. Sometimes the acronyms such as CADD or CAID are also used for "Computer-aided design and drafting" and "Computer-aided Industrial Design" respectively. These terms are mostly used in the sectors related to the manufacturing of engineering goods. As far as textile industry is concerned, CAD is generally used for interpreting computerized designing. It includes both software and sometimes special-purpose hardware.

### 15.2 APPLICATION OF CAD

The textile designs are the original works of the designers. CAD helps them to visualize and see their imaginative design in the final form without producing any sample watch. Sometimes, the customers too provide ideas for designing according to their requirements. These are in the form of painted artwork or fabric samples and sometimes film negatives. The textile designers, with the help of CAD, convert them into workable designs. For this to be done, the sample is scanned with the help of either scanners or digital cameras and then is edited to obtain the final design of a fabric.

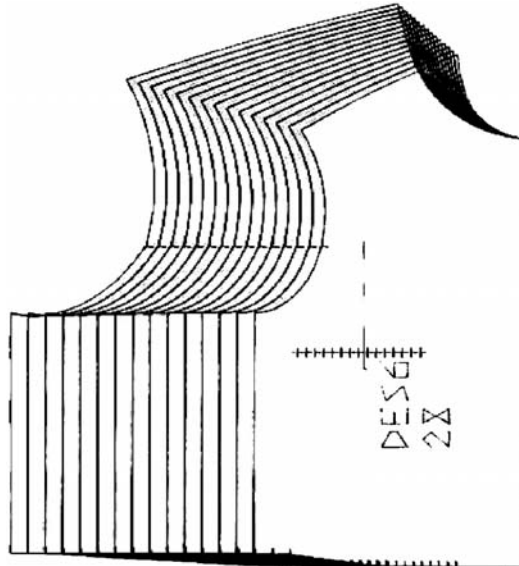
CAD is an accurate pattern making software for perfect fitting garments. It is an integrated suit of software, including pattern design, grading, detailing, marker layout and CAD drafting. A practical affordable pattern making software system is ideal for home based or commercial business.

Different areas of Textiles where the CAD systems are mostly used in:

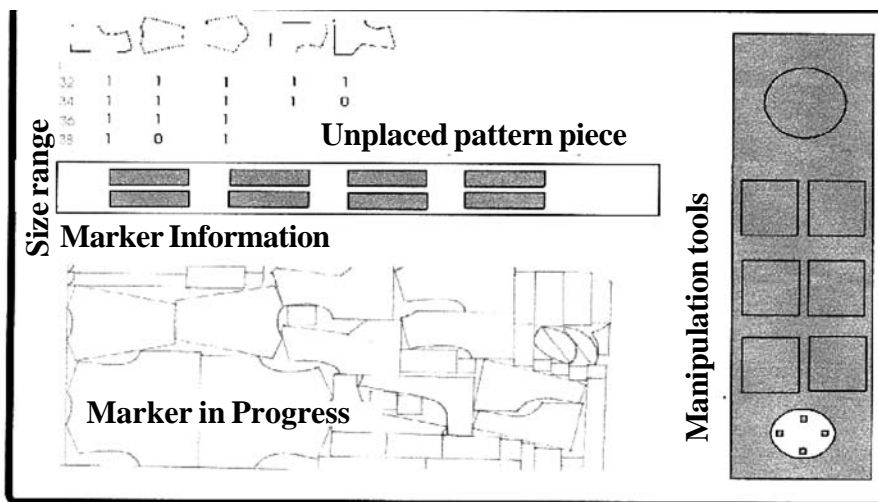
- Textile Design System: Most fabrics, yarn dyes, Plain weaves, jacquards or dobbies can be designed using a CAD.
- Knitted Fabrics: Some systems specialize in knitwear production and final knitted design can be viewed on screen with indication of all stitch formation.
- Printed Fabrics: The print motif can be resized, recoloured, rotated or multiplied depending on the designer's goal. New CAD systems are coming which have built in software to match swatch colour to screen color to printer color automatically.

- Sketch Pad Systems: There are graphic programs that allow the designer to use pen or styles on electronic pad or tablet thereby creating freehand images which are stored in the computer.
- Embroidery Systems: It requires assigned color and stitch to different parts of the design. Data is fed and multiple head work. Scanned images can also be used.
- Digitizing Systems: This can be done by defining the X, Y co-ordinates of series of selected prints around the pattern.
- Grading Systems: Certain points considered as “Growth Points” at which the pattern has to be increased to accommodate different body size like 32/34/36 and so on (Fig.15.1).
- Marker Making Systems: It ensures minimal wastage of fabric. Striped fabric can also be done.
- Cutting Operations: Automated Cutting machines can be used after direction from marker making.

So, it is said that, the CAD in Textiles is really dominating with its exclusive features and efficiency. CAD helps textile designers to make a new design in a more efficient way within a shorter duration. In every section of Textile, the Weaving CAD, the Printing CAD, the Marker Making CAD etc. are being used.



**Fig. 15.1**



**Figure 15.2.**

### **15.3 CAD HARDWARE AND SOFTWARE**

Generally speaking, computer hardware and software can be described as follows:

**Hardware :** Computer hardware is the equipment that can be observed. This could include equipments such as the monitor, hard-drive, keyboard and mouse. Peripherals can be added to the hardware to perform certain tasks and could include plotters, digitizing tables or printers.

**Operating systems :** An operating system is the vehicle through which the hardware can read the software programmes. These operating systems are used in combination with software programmes. Certain software programmes can only operate on specific operating systems. Examples of operating systems could be Windows, Linux or Mac.

**Software :** Software programmes are written to perform certain tasks. For example, the software programme, Microsoft Office is generally used, when writing documents. Other software programmes, such as Corel Draw, are used to create or modify graphic images. Generic software programmes are software programmes, which can be used in a number of disciplines. Corel Draw can be used for design in Graphic Design as well as Fashion Design. Dedicated software is written solely for use in a specific discipline. For example Stork is a software programme written exclusively for use in design.

### **15.4 TEXTILE SOFTWARES**

The usefulness of CAD has driven the market to produce specific software for different aspects of textile and apparel manufacturing. If there are software for designing footwear, caps and bags, there are pattern-making software too for fashion industry. There are solutions for sewn goods industry as well as systems for the design of jacquard woven fabrics. The garment pattern designs are even available in home, expert, and professional versions. Precision cutting systems, cutting and plotting systems, pattern design, grading and marker making- you name it and there is software for every textile related work- this is IT revolution in textile industry.

### **15.5 TYPES OF CAD SOFTWARE**

Software developers have benefited immensely by developing various CAD software. Various CAD software offer two-dimensional designs, as well as three-dimensional designs. CAD has made it possible for two people in two remote corners of the world to design and create new products using CAD software through the Internet. Artists, mechanical, electronics and civil engineers, architects and interior decorators use CAD software to aid in their designing process.

Designers have two kinds of CAD software to choose, either use the existing 2-D CAD software or go for more advanced 3-D CAD software. Some applications are inherently 2-D based. AutoCAD, Cad key, CADD5, Medusa, and CATIA v4 are examples of 2D CAD software.

### **15.6 DESIGNING SOFTWARE**

Corel draws, Adobe illustrator, Adobe Photoshop are popular programmes used by designers in various fields and several companies publish software.

#### **15.6.1 Corel Draw**

Corel draw is a vector graphic software, allowing the user to produce world-class illustrations with 16.7 million colours.

## **Salient Features**

- Create illustrations from scratch, enhance the designs, use and embellish scanned photos of designs and export designs in many ways.
- A vector based drawing programme with extensive text handling and precision-drawing features can be used to enhance a design.
- It is an ideal tool for virtually any design project from designing to technical illustrations, advertisements, publishing and Internet publishing.

## **Application**

- Full colour design illustration.
- Complex design drawing
- Fashion designing
- Photo realistic design image
- Surrealistic image
- Animation sequences
- Libraries of designs
- High quality drawing from low resolution originals
- Web page designing.

### **15.6.2 Adobe Illustrator**

Adobe illustrator is the designing and pattern making software. Illustrator is not a tailor made fashion application. It can also do many other things that fashion specific applications can't. Illustrator is a very powerful tool for any graphic design work you can throw at. It is in many ways a jack of all trades, capable of doing a range of tasks such as graphic design, fashion sketches, fashion illustration, trim design, fashion prints and so on. Illustrator is at first, a fashion design production tool by fashion design production. These will then be of a high standard. to be sent straight to the factory, to start prototypes production.

Adobe illustrator has long been considered the norm for drawing technically correct and detailed plans of-\* flats. However, some industry individuals comment that the computer generated flats have a sense of looking "too perfect" regardless of your preference, if there is a hand drawn flat that needs to be copied to look very technical.

### **15.6.3 Adobe Photoshop**

In designing, Photoshop is ever evolving and is primarily marked for the photo retouching and graphic design industries. It will never truly address the full needs of the textile market. However it is a great stepping stone for designers to begin their journey with CAD.

## **15.7 PATTERN MAKING SOFTWARE**

**Gerber :** Computer aided design, commonly referred to as CAD, Gerber is known as a leading supplier in high technology and solutions. The company develops hardware and software to automate pattern design, grading and marker making. Since the 1960s, it offers solutions for companies to remain up-to-date with technology and fashion. Their goal is to help designers and pattern makers work as efficiently as possible in an automated environment for a quick turnaround of final designs garments and products. Gerber technology is used in the apparel, furniture, transportation, industrial fabrics and composites industries. If it is a sewn product, it is likely to be created on a Gerber system.

Pattern Designing Software (PDS) is widespread in Germany and Italy. The other new development in the market place of system software is Pattern Generation Software (PGS). At present the two packages have been used called conex and PGS.

## **15.8 ADVANTAGES OF CAD**

Easy to operate designing system- CAD has many advantages.

- The expense and time is reduced in a considerable manner when compared to the laborious manual work of designing.
- Designing can be done from anywhere, as the customers are able to control the process from remote locations as well.
- The data can be easily stored, transmitted, and transported through computer files.
- Digital swatches can be saved on floppy disks, zip disks, CD-ROM or hard drive thus saving space. Moreover they can be easily organized for fast and easy retrieval.
- The designs can be easily customized and personalized as corrections and editing can be done at any time without significant delays or cost increases.
- The designers do not need to produce swatches all the time as they can now see how a particular fabric or garment looks in different colors and shapes on the computer screen itself.

## **CONCLUSION**

With all its benefits, care too has to be taken before going for any CAD software. The software, which is supported by the available hardware, should only be purchased or the hardware should be upgraded to comply with the new software. Training too has to be given to the people who operate the system so that maximum benefit may be taken from it. With careful selection and trained professionals, the textile industry can enjoy the benefits of the IT revolution right at their door.

## QUESTIONS

### I. Choose the Correct Answer

1. CAD is a \_\_\_\_\_ tool that enables you to make quick and accurate drawings with the use of a computer.  
a) Electronic      b) Current      c) Software      d) Hardware
2. \_\_\_\_\_ can be used for design in Graphic Design as well as Fashion Design.  
a) Photoshop      b) CAD      c) Corel Draw      d) None of the above
3. The points at which the pattern has to be increased are \_\_\_\_\_  
a) Growth points      b) Edges      c) Side Points      d) Bottom line
4. Pattern-designing software is widespread in \_\_\_\_\_  
a) Germany      b) Italy      c) India      d) Both A and B
5. The data can be easily stored, transmitted and transported through  
a) Hardware files      b) Software files      c) Both A and B      d) Computer files

### II Write short answers

1. Define CAD.
2. Explain Printed Fabrics.
3. Explain Grading Systems.
4. Write any five application of Corel draw.
5. Explain Adobe Photoshop.

### III Give brief answers

1. Explain CAD Hardware and Software.
2. What are the advantages of CAD?
3. Explain Salient Features of Corel Draw.
4. Explain Pattern Making Software.
5. Explain Adobe Illustrator.

### IV Give detailed answers

1. Explain about the different areas of Textiles where CAD systems are used.
2. Explain designing software.

### Answers

#### I Choose the Correct Answer

1. c      2. c      3. a      4. d      5. c



# 16. ADVERTISEMENT

## INTRODUCTION

Information is considered to be the most valuable resource in the present day's society and in its economy. The availability of information is more or less a right of the society as it stimulates all economic activity and growth. In the case of marketing as well passing of information is of vital importance. It includes the name of a product or service and how that product or service can benefit the consumer. It persuades a target market to purchase or consume that particular brand through mass media. Mass media can be defined as any media meant to reach the general mass. There are several types and they are television, internet, radio, news programs, published pictures and articles to name a few. Advertising can also serve as a media to communicate an idea to the mass in an attempt to convince them to take certain actions such as encouraging 'environmentally friendly' behaviours and eschew unhealthy behaviours like smoking. Information can be imparted to the children through television programmes as well as through video games.

### 16.1 DEFINITION

“Advertising is a non-personal communication of information usually paid for and usually persuasive in nature about products, services or ideas by identified sponsors through the various media.”

### 16.2 OBJECTIVES

- To promote a single product or service.
- To make an immediate sale.
- To create the branding of the product.
- To introduce a price deal.
- To inform about new products availability or features.
- To build an overall company image.
- To effect immediate buying action.
- To increase market share.

### 16.3 CLASSIFICATION OF ADVERTISING

It is classified under nine heads.

#### 16.3.1 Product advertising

A normal characteristic of advertising is to create primary demand for a product category rather than for a specific brand. It is wrongly believed that product advertising must stress on brand name. This is based on the feeling that a good image often enhances the effectiveness of product advertising. However, in practice, most companies are successful in building the product image by using the brand names (e.g., Dettol, Horlicks). In short, when the company tries to sell its product or services through advertising it is referred to as product advertising.

### **16.3.2 Institutional advertising**

These advertisements are not always directed to consumers. Instead, it is aimed at many of the various types of public (shareholders, creditors, etc.). It is not product oriented but is rather designed to enhance the image of the company.

### **16.3.3 Primary demand advertising**

It is intended to stimulate primary demand for a new product or product category. It is heavily utilised during the introduction stages of the life cycle of the product.

### **16.3.4 Selective or competitive advertising**

When a product enters the growth stage of its life cycle, and when competition begins, advertising emerges and becomes selective. Here, the goal of advertising is to increase the demand for a specific product or service. Advertising may begin to stress subtle difference in brands, with heavy emphasis on 'brand name recall'. Pricing also will be used as a key promotional weapon as products become very similar.

### **16.3.5 Comparative advertising**

This is a highly controversial trend in today's competitive market. Such types of advertising play a decisive role on comparative features of two or more specific brands in terms of product / service attributes. This method is adopted in the maturity stage when similar products first appear in the market causing stiff competition.

### **16.3.6 Co-operative advertising**

When manufacturers, wholesalers and retailers jointly sponsor and share the expenditure on advertising, it takes the form of co-operative advertising. Such advertising carry the names of all the parties involved. From the customers' point of view this is beneficial, as they can get the articles directly from the authorised outlets.

### **16.3.7 Commercial advertising**

It is also termed as business advertising. As the name suggests such advertising is solely meant for effective increase in sales.

### **16.3.8 Non-commercial advertising**

These are usually published by charitable institutions preferably to solicit general and financial help (such as collection of donation or sale of tickets).

### **16.3.9 Direct action advertising**

Advertising that stresses and persuades immediate buying of the product is known as direct action advertising. Direct mail advertising is capable of achieving immediate action to a large extent.

## **16.4 TYPES OF ADVERTISING**

### **16.4.1 Television Advertising - TV**

TV advertising is a popular way to mass-market messages to large audiences. Although this medium has the ability to reach a high number of potential buyers, it is also one of the most costly forms of advertising

### **16.4.2 Radio Advertising**

Radio advertising is an effective way for businesses to target a group of people based on location or similar tastes.

### **16.4.3 Print Advertising**

Magazine and newspaper advertisements are another way to spread the word about a product or service. Print advertising also offers the ability to target specific audience based on geography or common interests. Print advertising usually includes larger display ads, as well as classified advertising. The classifieds are typically very affordable, whereas display ads are a bit pricey.

### **16.4.4 Online Advertising**

Advertising online is an increasingly popular method for promoting a business. There are many forms of online advertising. Banners are image advertising displayed on web pages. Google advertisement is another popular form of online advertising that matches an ad to an internet user's search inquiry.

### **16.4.5 Billboard Advertising**

Billboard advertisements are large advertisements displayed on structures in public places. Most commonly, billboards are located along the highways to target the passing motorists.

### **16.4.6 In-store Advertising**

In-store advertising, takes place within a retail store. For example, a company that produces a new cleaning product might include an end cap display when they ship the product to stores. This gives the store an attractive display that draws attention to the new product. Other types of in-store advertising include banners and display cases.

### **16.4.7 Word of Mouth Advertising**

While some may argue that word of mouth is not advertising because it is free, this form of promotion is one of the best and the most credible and priceless asset of any business. Even if business owners cannot buy word of mouth advertising, they can encourage their customers to tell their friends and family about the great product or service they purchased.

### **16.4.8 Endorsements**

Endorsement is similar to word of mouth promotion but typically does involve money. Having a product or service endorsed by a celebrity can increase sales and product awareness. Not every company can afford to have major A-list celebrities promoting a product. Smaller companies consider using local celebrities or well-known individuals within the product's niche market.

## **16.5 ADVANTAGES OF ADVERTISING**

- Broadens the knowledge of the consumers.
- Helps easy introduction of products into the market.
- Increases sale volume.
- Helps to create image of the product and the company.

- Enables them to have product information.
- Creates awareness on product and service.
- Maintains retail price.
- Increases the rate of the turnover of stock.
- Provides an opportunity to the customers to compare the merits and demerits of various substitute products.
- Helps to establish direct contact between manufacturers and consumers.
- Leads to large-scale supply for demand, creating more employment opportunities.

## CONCLUSION

The advertising is a highly cost incurring method, its efficiency and effectiveness should be ensured. It is for this, purpose that concept of scientific advertising should be carefully planned and efficiently implemented and promptly monitored and controlled.

## QUESTIONS

### I. Choose the correct answer

- Which is the best tool for sales promotion?  
 a) Store image                      b) Window display                      c) Advertisement                      d) Price offer
- Which type of advertisement ranges a high cost?  
 a) Television                      b) Radio                      c) Print                      d) Online
- Which type of advertisement is low cost?  
 a) Endorsements                      b) Radio                      c) Print                      d) Word of Mouth
- Which is termed as business advertising?  
 a) Commercial                      b) Non commercial                      c) Online                      d) Direct action advertising
- Celebrities are very important for which type of advertisement?  
 a) Commercial                      b) In-store                      c) Online                      d) Endorsements

### II Write in one or two sentences

- Define advertising.
- Explain objectives of advertising.
- Explain product advertising with examples.
- Explain the best type of advertisement.
- Write a note on comparative advertising.

### **III Write brief answers**

1. Write a note on different types of advertising.
2. Explain classification of advertising.
3. Distinguish between product and institutional advertising.
4. Explain advantages of advertising.
5. Distinguish between television and radio advertising.

### **IV Give detailed answer**

1. Define advertisement and explain in detail.

### **Answers**

#### **I. Choose the correct answer**

1. c                      2. a                      3. d                      4. a                      5. a

# 17. ENTREPRENEURSHIP DEVELOPMENT

## INTRODUCTION

Starting and operating a new business involve considerable risk and effort to overcome the inertia against creating something new. In creating and growing a new venture, the entrepreneur assumes the responsibilities and risks for its development, survival and enjoys the corresponding rewards. The fact is that consumers, business people, and government officials are interested in entrepreneurship.

### 17.1 DEFINITION

According to D.C.McClelland entrepreneur and entrepreneurship are defined as follows: “Entrepreneur” is a person who creates an enterprise and the process of creation is called as “entrepreneurship”.

Entrepreneurship is doing things in a new and better way and decision-making under the condition of uncertainty.

The assumption of risk and responsibility in designing and implementing a business strategy or starting a business. -Encyclopedia Britannica

Entrepreneurship is the function of foreseeing investment and production opportunity, organizing an enterprise to undertake a new production process, raising capital, hiring labour, arranging for the supply of raw materials, and selecting managers for day-to-day operation of the enterprise.

-Benjamin Higgins

### 17.2 WHO IS AN ENTREPRENEUR?

- A person who develops and owns his own enterprise
- A moderate risk taker and works under uncertainty for achieving the goal
- Reflects strong urge to be independent and innovative
- Persistently tries to do something better
- Dissatisfied with routine activities
- Prepared to withstand the hard life.

### 17.3 FUNCTIONS OF AN ENTREPRENEUR

- Perceiving market opportunities
- Gaining command over scarce resources
- Managing human relations within firms
- Marketing of the products
- Responding to the competition
- Dealing with bureaucracy
- Managing finance

- Upgrading process and product quality
- Managing customer and supplier relations
- Introducing new production techniques and products
- Risk Taking

#### **17.4 THE CHARACTERISTICS OF A UNIQUE ENTREPRENEUR**

- Need for achievement
- High need for power
- Independence
- Propensity to take risk
- Personal modernity
- Support
- Business enterprise
- Leadership
- Determined but patient
- Exhibits sense of leadership
- Also exhibits sense of competitiveness
- Takes personal responsibility
- Oriented towards the future
- Tends to persist in the face to adversity
- Convert a situation into opportunity

#### **17.5 ENTREPRENEURIAL MOTIVATION FACTORS**

- Educational background
- Occupational Experience
- Desire to work independently
- Desire to branch out to manufacturing
- Family background
- Assistance from Government
- Assistance from financial institution
- Availability of technology/raw material
- Profit margin

- Desire for taking personal responsibility
- Anticipation of future possibilities

### **17.6 QUALITIES OF A GOOD ENTREPRENEUR**

According to McClelland:

- An unusual creativeness
- A propensity of risk taking
- A strong need for achievement

According to Prof. Tandon:

- Capacity to assume risks
- Technical Knowledge and willingness to change
- Ability to marshal resources
- Ability of organization and administration

### **17.7 TYPES OF AN ENTREPRENEUR**

There are five types of entrepreneurs

- **Innovating Entrepreneurs:**

They are aggressive in experimentation and clever in putting attractive possibilities into practice.

- **Adoptive or Imitative Entrepreneurs:**

They adopt best practices. Imitative entrepreneurs are revolutionary and important.

- **Fabian Entrepreneurs:**

They display great caution and skepticism in experimenting with any change in their enterprise.

- **Drone Entrepreneurs:**

They are against any change in production method even at the cost of losses.

- **Forced Entrepreneurs:**

They become entrepreneurs on account of circumstances.

### **17.8 NEED OF ENTREPRENEURSHIP**

The Network of Entrepreneurship and Economic Development (NEED) brings together under-privileged communities with the teams of Social Entrepreneurs in order to maximize human resource potential and create positive change in their socio-economic and political environment.

This is achieved through:

- Mainstreaming Gender Issues
- Micro-Enterprise and Entrepreneurial Skills Development



- Career driven focused Vocational Skill Training and upgradation.
- Pro-poor driven advocacy for Intellectual Property Right (IPR) towards registering the indigenous products through Geographical Indicators (GI) and economics governance.
- Women's and Children's Health, including Water and Sanitation
- Rural Asset Management, including Natural Resources
- Capacity Building Development in Locally Specific Resource Groups
- Networking Towards Grassroots Activism and Global Change
- Service driven Micro-Finance supports to groups

### **17.9 THREE ASPECTS OF ENTREPRENEURSHIP**

1. The identification/recognition of market opportunity and the generation of a business idea (product or service) to address the opportunity.
2. The marshalling and commitment of resources in the face of risk to pursue the opportunity.
3. The creation of an operating business organization to implement the opportunity-motivated business idea.

### **17.10 PROJECT IDENTIFICATION**

Project Identification is a collection, compilation and analysis of data to locate potential opportunities for starting business and development of such opportunities. Opportunity is a business concept, which if turned into a tangible product or service, by the enterprise, will result into profit. It is all about creating values. The search of a good idea, generate your own idea and develop someone else's idea. Opportunities are identified through innovation/search of business ideas.

#### **Types of innovation:**

There are three types of innovation

1. Additive Innovation – Fully exploiting already existing resources, such as product lines extensions complementary.
2. Innovation – Offers something new and introduces a few changes in the structure of the business.
3. Breakthrough Innovation (Radical Innovation) – Changes the fundamentals of the business, creating a new industry and new avenues for extensive wealth creation

### **17.11 IMPORTANCE OF PROJECT IDENTIFICATION ENTREPRENEURSHIP MANAGEMENT**

- It has long term consequences (make or break)
- Involves commitment which can not be easily reversed
- Ideas are put into action
- Projects are catalytic agents for economic development
- Involves creative use of resources- manpower, capital, raw materials etc.

- Generates value addition and build-up national capital
- Brings socio-cultural development
- Leads to development of infra-structure and environment

#### **17.12 CRITERIA FOR SELECTING A PROJECT ENTREPRENEURSHIP MANAGEMENT**

- Investment size
- Location of project
- Technology to be used
- Equipment
- Marketing

#### **17.13 CONSTRAINTS IN PROJECT FORMULATION ENTREPRENEURSHIP MANAGEMENT**

- Lack of a viable / feasible project idea
- Lack of realistic/ achievable objectives
- Lack of necessary resources / infrastructure to convert idea into reality
- Policies of government / Legal restrictions
- Lengthy and cumbersome procedures to get finance and start business

#### **17.14 STAGES OF PROJECT FORMULATION ENTREPRENEURSHIP MANAGEMENT**

1. Feasibility Analysis (First stage in project formulation)
2. Techno-Economic Analysis (Screens the idea to- Estimate of potential of the demand for goods/ services)
3. Project Design and Network Analysis (The sequence of events of the project and it identifies project inputs, finance needed and cost-benefit profile of the project)
4. Input Analysis (Assesses the input requirements during the construction and operation of the project)
5. Financial Analysis (Involves estimating the project costs, operating cost and fund requirements)
6. Cost-Benefit Analysis (It considers costs that all entities have to bear and the benefit connected to it)
7. Pre-Investment Analysis (Helps the project-sponsoring body, the project-implementing body and the external consulting agencies to accept/reject the proposal)

#### **17.15 A PROJECT REPORT GIVES INFORMATION ON THE FOLLOWING**

- Economic aspects – present market, scope for the growth, justification for investment
- Technical aspects – technology, machinery, and equipment needed

- Financial aspects – Total investment needed, entrepreneur’s contribution, cost of capital and return on capital
- Production aspects – Product details, justification for the choice of product, export worthiness
- Managerial aspects – Qualifications, experience of people needed for managerial posts

The project report is submitted to financial institutions for grant of land and other financial concessions. Organizations like Small Industries Service Institute (SISI) and Small Industries Development Organization (SIDO) help entrepreneurs to prepare project report. The financial institutions ascertain from the report, whether the project can generate enough funds to repay the borrowings in stipulated time frame.

### **17.16 WHAT IS FINANCIAL MANAGEMENT?**

Financial Management can be defined as the management of the finances of a business / organization in order to achieve financial objectives.

The key objectives of financial management would be to:

- Create wealth for the business
- Generate cash, and
- Provide an adequate return on investment bearing in mind the risks that the business is taking and the resources invested.

### **17.17 THERE ARE THREE KEY ELEMENTS FOR THE PROCESS OF FINANCIAL MANAGEMENT**

#### **17.17.1 Financial planning**

Management needs to ensure that enough funding is available at the right time to meet the needs of the business. In the short term, funding may be needed to invest in equipment and stocks, pay employees and fund sales made on credit. In the medium and long term, funding may be required for significant additions to the productive capacity of the business or to make acquisitions.

#### **17.17.2 Financial control**

Financial control is a critically important activity to help the business ensure that the business is meeting its objectives.

#### **17.17.3 Financial decision-making**

The financial decision is whether profits earned by the business should be retained rather than distributed to shareholders via dividends. If dividends are too high, the business may be starved of funding to reinvest in growing revenues and profits further.

#### **17.17.4 The role of the budget**

- The budget is a part of the foundation upon which an organization justifies its mission.
- It establishes financial parameters through which the organization can determine its objectives and attain its goals.

- An estimation of revenue and expenses for a given period of time, usually 1-2 years.
- Anticipate or predict cash flow as well as control cash flow.

#### **17.17.5 Financial ratios**

Financial ratios are useful indicators of a firm's performance and financial situation. Most ratios can be calculated from information provided by the financial statements. Financial ratios can be used to analyze trends and to compare the firm's financials to those of other firms. In some cases, ratio analysis can predict future bankruptcy.

### **17.18 BOOKKEEPING**

Bookkeeping is the recording of financial transactions. Transactions include sales, purchases, income, and payments by an individual or organization. Bookkeeping is usually performed by a bookkeeper.

#### **17.18.1 Steps to start a small scale industry**

The following are steps to start a small scale industry

- Description of the Business
- Product/Service
- The Location
- The Marketing Plan
- Competition
- Pricing and Sales
- Advertising and Public Relations
- The Management Plan
- Self-Paced Activity
- The Financial Management Plan.

#### **17.18.2. Description of the business**

The business description section is divided into three primary sections. Section 1 actually describes about business, Section 2 describes about the product or service and Section 3 the location of business, and why this location is desirable.

#### **17.18.3 Product / service**

Try to describe the benefits of goods and services from your customers' perspective. Successful business owners know or at least have an idea of what their customers want or expect from them.

- How will the product or service benefit the customer?
- Which products/services are in demand? Will there be a steady flow of cash?
- What makes the product/service different and desirable?

#### **17.18.4 THE LOCATION**

The location of the business can play a decisive role in its success or failure. The location should be built around the customers, it should be accessible and it should provide a sense of security.

#### **17.18.5 THE MARKETING PLAN**

Marketing plays a vital role in successful business ventures. How well they market the business, along with a few other considerations, will ultimately determine degree of the success or failure. The key element of a successful marketing plan is to know about customers-their likes, dislikes, and expectations.

#### **17.19 COMPETITION**

Competition is a way of life. Nations compete for the consumer in the global marketplace, as do individual business owners. Advances in technology can send the profit margins of a successful business into a tailspin causing them to plummet overnight or within a few hours. When considering these and other factors, it can conclude that business is a highly competitive, volatile arena. Because of this volatility and competitiveness, it is important to know about competitors.

#### **17.20 PRICING AND SALES**

Pricing strategy is another marketing technique that can be used to improve overall competitiveness. Get a feel for the pricing strategy the competitors are using. Determine prices in line with competitors in the market area and verify if they are in line with industry averages.

Some of the pricing strategies are:

- Retail cost and pricing
- Competitive position
- Pricing below competition
- Pricing above competition
- Price lining
- Multiple pricing
- Service costs, components and pricing (for service businesses only)
- Material costs
- Labor costs
- Overhead costs

#### **17.21 ADVERTISING AND PUBLIC RELATIONS**

Advertising and promotion, however, is the lifeline of a business and should be treated as such. Devise a plan that uses advertising and networking as a means to promote business.

#### **17.22 THE MANAGEMENT PLAN**

Managing a business requires more than just the desire to be one's own boss. It demands dedication, persistence, the ability to make decisions and the ability to manage both employees and finances.

## **Operating Budget**

- Personnel
- Insurance
- Rent
- Depreciation
- Loan payments
- Advertising/promotions
- Legal/accounting
- Miscellaneous expenses
- Supplies
- Payroll expenses
- Salaries/wages
- Utilities
- Dues/subscriptions/fees
- Taxes
- Repairs/maintenance

### **17.23 THE FINANCIAL MANAGEMENT PLAN**

- Funding of capital projects
- Developing new products and services
- Retiring products and services
- Selling assets, purchasing assets, protecting assets
- Moving an organization to a new location
- Tax liabilities

#### **17.23.1 QUALITY CONTROL**

Quality control is a process by which entities review the quality of all factors involved in production. This approach places an emphasis on three aspects:

- Elements such as controls, job management, defined and well managed processes, performance and integrity criteria, and identification of records
- Competence, such as knowledge, skills, experience, and qualifications
- Soft elements, such as personnel integrity, confidence, organizational culture, motivation, team spirit, and quality relationships.

### 17.23.2 Quality control in project management

In project management, quality control requires the project manager and the project team to inspect the accomplished work to ensure that it is aligned with the project scope. In practice, projects typically have a dedicated quality control team which focuses on this area. Quality control is a process employed to ensure a certain level of quality in a product or service. It may include whatever actions a business deems necessary to provide for the control and verification of certain characteristics of a product or service.

### CONCLUSION

Entrepreneurs must understand all aspects of their business. They should have the knowledge and skills to buy the right supplies, keep complete financial records, and manage people in a way that they can be highly productive. Entrepreneurs need to project a professional image with well designed business cards and letterhead stationary. Many entrepreneurial opportunities exist that can be operated from a home, store, factory or warehouse. Small boutiques or specialized stores can be formed anywhere there are consumers. Technology enables small business owners to keep in touch with both suppliers and customers.

### QUESTIONS

#### I. Choose the correct answer

- \_\_\_\_\_ is the recording of financial transactions  
a) File keeping    b) Paper keeping    c) Bookkeeping    d) Mind keeping
- \_\_\_\_\_ and promotion, however, is the lifeline of a business  
a) Marketing    b) Advertising    c) Selling    d) Purchasing
- \_\_\_\_\_ is innovative  
a) Observer    b) Retailer    c) Entrepreneur    d) Home maker
- Financial Management can be defined as the management of the \_\_\_\_\_  
a) Finances    b) Resources    c) Materials    d) Income
- \_\_\_\_\_ is a way of life  
a) Competition    b) Consumers    c) Whole sellers    d) Manufacturers

#### II. Write short answers

- What is entrepreneurship?
- Define entrepreneur.
- Give the objectives of financial management.
- Give any 4 functions of entrepreneur.
- List the criteria for selecting a project entrepreneurship management.

### **III. Give brief answers**

1. Write about the 3 key elements to the process of financial management.
2. What are the steps to start a small industry?
3. Write about the types of an entrepreneur.
4. What are the stages of project formulation entrepreneurship?
5. Give some of the pricing strategies.

### **IV. Give detailed answer**

1. Write about the qualities of good entrepreneur? Write about the need and the three aspects of entrepreneurship.

### **Answers**

#### **I. Choose the correct answer**

1. c                      2. b                      3. c                      4. a                      5. b



# PRACTICALS I

## 1. MAGYAR FROCK

### Introduction

This dress is worn by children (girls) 1-5 years old. Shoulder and sleeve part is seen as folds. Skirt is stitched on the waist line. In the neckline collar or piping can be stitched.

**Suitable materials:** Poplin, flowered cotton fabrics, silk and fancy type fabrics.

**Fabric requirements:** Twice the length of the dress and 5cms for fold.

### Measurements:

Chest	:	22"
Body length	:	9½"
Skirt length	:	12½"
Sleeve length	:	2½"
Upper arm circumference	:	8"

### INSTRUCTIONS FOR DRAFTING:

#### Body part

Draw or rectangle ABCD

AB = CD = Body length

AC = BD =  $\frac{1}{4}$  chest circumference +  $\frac{1}{2}$ " for case

AE = Back neck depth = 2½"

AF = Neck width = 2"

AG = Front neck depth = 3½"

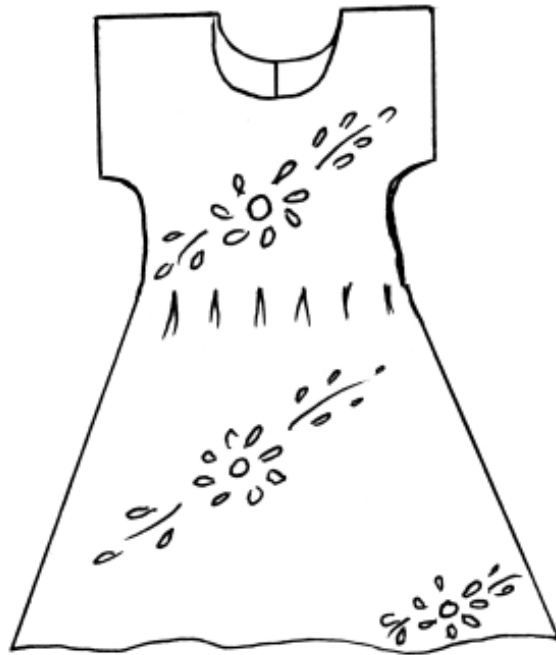
CH = Sleeve length = 2"

CI =  $\frac{1}{2}$  Upper arm circumference

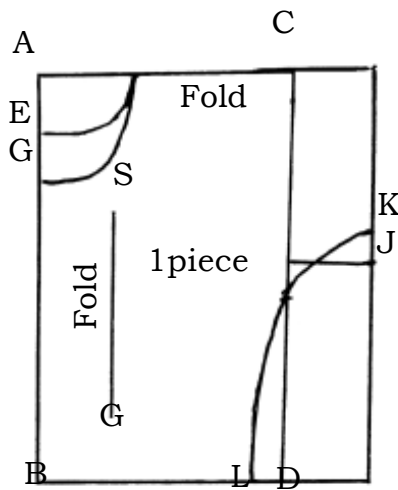
Draw HJ parallel to CI

CH = IJ

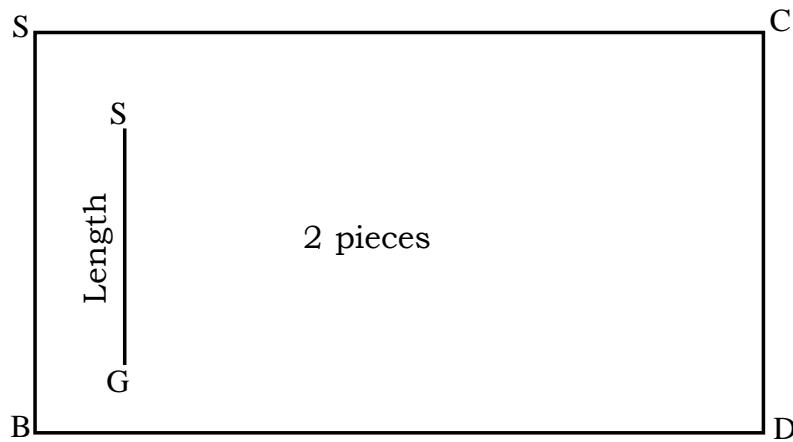
HK = lower arm circumference



**Fig. 1**



**Fig. 2**



**Fig. 3**

DL = ½” JK = ½”

Join KL side line seam through I.

EFCHKLBE = Back part

GFCHKLBG = Front part

SG = Lengthwise.

### **Skirt part**

AB = CD = skirt length + 1½” fold

AC = BD = Width needed for gatherings

(Twice the waist circumference)

SG = Length wise

### **Pattern prices**

Shoulder part is folded so, front & back pieces are seen as attached together.

Hence, body piece – 1

Skirt piece – 2

Facing and binding pieces for placket – 2

Cross piece for neck line:

### **Stitching Method**

1. Place the paper pattern on the fabric. Leave seam allowance for stitching French seam and to attach with the skirt. Now cut the body part accordingly.
2. Fold sleeve edge and hem.
3. Join side line and stitch French seam.
4. To the back part neck line cut placket open and stitch facing and binding pieces.
5. To the neck edge attach cross piece, fold and hem.
6. Join skirt part to body part after stitching gathering or pleats according to the waist circumference.
7. Finish bottom edge of the skirt by folding and stitching.

**Note :** The difference between the body measurement and the garment measurement is ease.

## 2. YOKE FROCK

### Introduction

This dress is worn by girl children of 2 to 4 years age. The upper part of the frock is the yoke and the lower part is the skirt. In the neck desired collar or piping can be stitched. Arm hole part is attached with puff sleeve and it gives a good appearance. Chest part is finished with embroidery or smocking work.

**Suitable materials:** Soft cotton fabrics, huckobha, fancy materials can be selected.

**Fabric requirements:** 36" width fabric – 1 meter.

### Measurements:

Chest	:	22"
Yoke length	:	4"
Shoulder width	:	10"
Skirt length	:	14"
Sleeve length	:	5"
Upper arm circumference	:	10"

### Instructions for Drafting

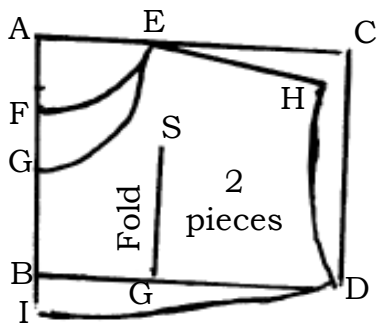
#### Yoke part

AB	=	CD = Yoke's length
AC	=	BD = $\frac{1}{4}$ Yoke's chest circumference
AE	=	Neck width = 2"
AF	=	Back neck depth = $1\frac{1}{2}$ "
AG	=	Front neck depth - $2\frac{1}{2}$ "
AH	=	$\frac{1}{2}$ Shoulder width
HD	=	$\frac{1}{2}$ Upper arm circumference
BI	=	$\frac{1}{2}$ "
DI	=	Yoke's lower design.



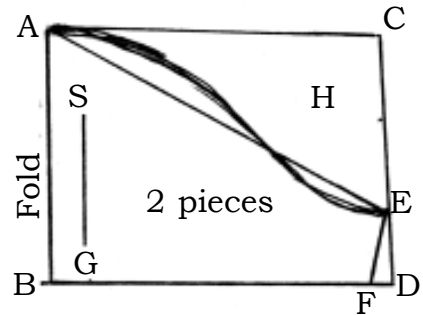
**Fig. 1**

**Yoke Part**



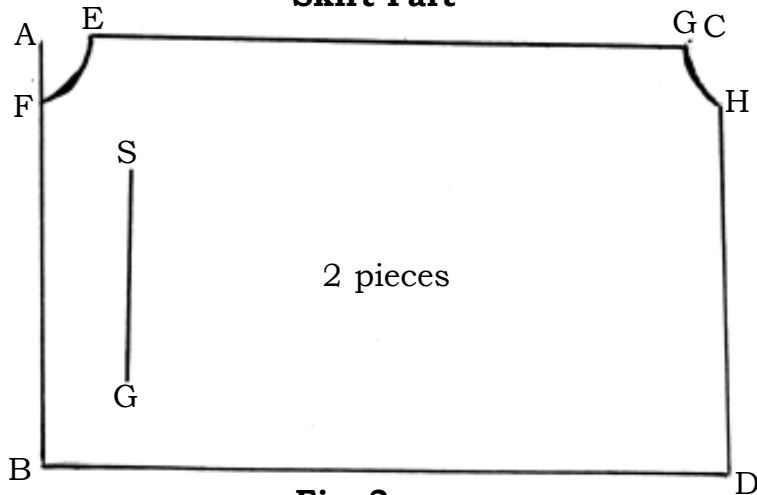
**Fig. 2**

**Sleeve Part**



**Fig. 4**

**Skirt Part**



**Fig. 3**

FEHDIBF = Front part  
GEHDIBG = Back part  
SG = Length wise

**Skirt part**

AB = CD = Skirt length + 1½” fold  
AC = BD = Required width for gatherings  
EF, GH = Armscye depth cut from skirt.  
AF, CH = 1”  
SG = Length wise

**Sleeve part**

AB = CD = Sleeve length  
AC = BD = ½ sleeve width  
AE = Armscye depth  
EF = Side seam 1/3 of sleeve length  
DF = ½”

**Pattern pieces:**

Front yoke piece	=	1
Back yoke piece	=	2
Skirt pieces	=	2
Sleeve pieces	=	2
For plackets Facing pieces	=	1
Binding piece	=	1
Cross piece for neck part		

**Stitching Method**

1. Leave seam allowance and cut the front and back yoke parts from the fabric for stitching.
2. Join the shoulder parts of the front and back yoke part.
3. Cut the back neck part for placket, and stitch the facing and binding pieces.
4. Do gathering in the skirt part according to the yoke’s size.
5. Attach with the yoke & stitch.
6. Gathering is done in the upper part and lower part of sleeve and sleeve edges are done with piping. The side line is joined and finished.
7. Finished sleeve is adjusted and attached to the cut part of bodice and yoke armscye accordingly and stitched.
8. Side line of the bodice is joined and the bottom edge is finished by folding and stitching.

### 3. UMBRELLA SKIRT WITH ROUND YOKE

#### Introduction:

This dress can be worn by girl children of 3 to 8 years of age. From the upper bodice part of this umbrella skirt, round shaped yoke is cut and its is again attached to the bodice part. The round skirt is worn from the waist to below the knee. In the armscye part, designed sleeve can be attached and stitched. This umbrella skirt is a beautiful dress.

**Suitable materials :** Cotton Printed soft materials, fancy materials

**Fabric requirements :** Twice the length of the dress + sleeve length + 10cms

#### Measurements:

Chest	=	24"
Body length	=	9½"
Skirt length	=	12½"
Sleeve length	=	3"
Shoulder width	=	10"
Upper arm circumference	=	9"
Waist	=	11"

#### Body part

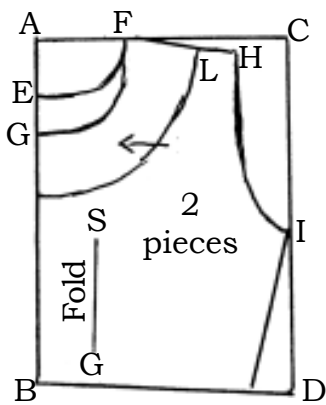
ABCD is a rectangle

#### Instructions for Drafting:

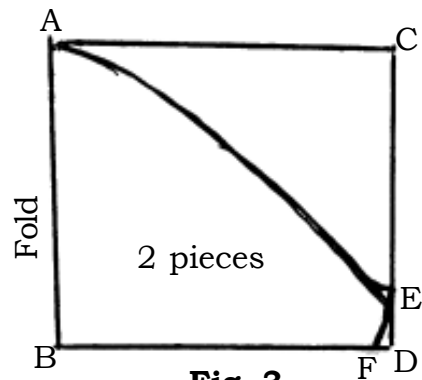
AB	=	CD = Body length
AC	=	BD = ¼ Chest width
AF	=	Neck width = 2½"
AE	=	Back neck depth = 1½"
AG	=	Front neck depth = 2½"
AH	=	½ Shoulder width
HI	=	½" Upper part sleeve circumference.
IJ	=	Side line



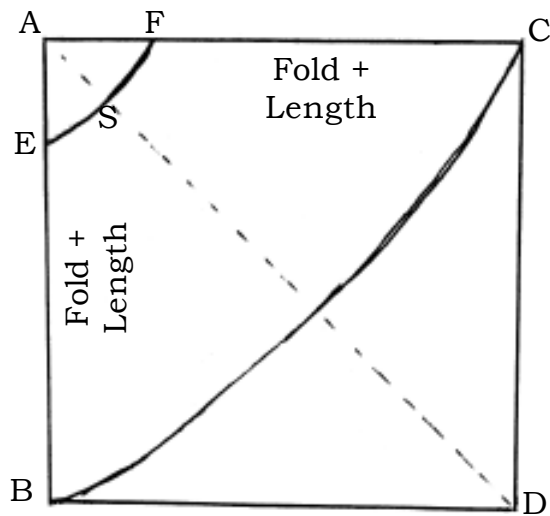
**Fig. 1**



**Fig. 2**



**Fig. 3**



**Fig. 4**



DJ =  $\frac{1}{2}$  = GF = KL (Round size yoke part)  
SG = Length wise  
EFHIJBE = Back part piece  
GFHIJBG = Front part piece  
GFKL = Round Yoke

### **Sleeve Part**

AB = CD = Sleeve length  
AC =  $\frac{1}{2}$  Sleeve circumference +  $\frac{1}{2}$ " ease  
AE = Armscye part (curved part)  
EF = Sleeve side line  
AEFB = Sleeve part

### **Skirt Part**

AB = CD = 4 folded squared fabrics  
EF =  $\frac{1}{4}$  waist circumference  
BC = Bottom edge round part  
OD = Dotted lines can be folded for cutting.  
FC = EB = Skirt length

### **Pattern pieces:**

Front piece – 1  
Yoke piece cut from front body piece – 1  
Back piece – 2  
Sleeve pieces – 2  
Placket pieces  
Neck line finishing pieces,  
Skirt piece

### **Stitching Method**

1. Leaving seam allowances for shoulder, side line, cut the bodice part from the fabric using the pattern.
2. Yoke part which is cut from the front body piece is again attached to the body part.
3. Join the shoulders and side lines.
4. Attach the sleeve to the body part.
5. Cut an open placket at the back neck and do facing & binding. Now finish the neckline with piping.

6. Fold the bottom edge of the round skirt and stitch. Then join the skirt part to the body part and stitch.
7. Fold the dress and press.

## 4. HALF SKIRT

### Introduction:

This skirt is worn by 5 to 10 years old girls and can be worn from waist to below the knee. A waist band is attached above the pleats i.e., ordinary pleat or box pleats. School uniforms are stitched in this method.

**Suitable materials:** Thick fabrics like binny, khaki, terycotton, polyester, can be used.

**Fabric requirements:** Twice the length of the dress + bottom fold and waist band.

### Measurements:

Length =  $19\frac{1}{2}$ " + 2" fold

### Instructions for drafting

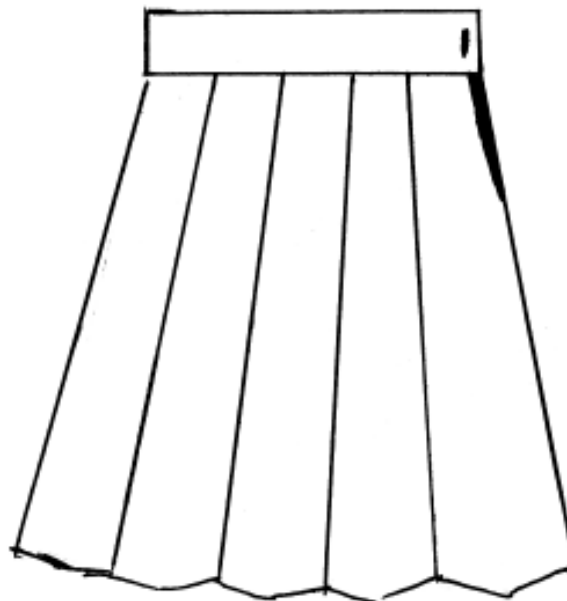
ABCD is a rectangle

AB = CD dress length + fold  $2\frac{1}{2}$ "

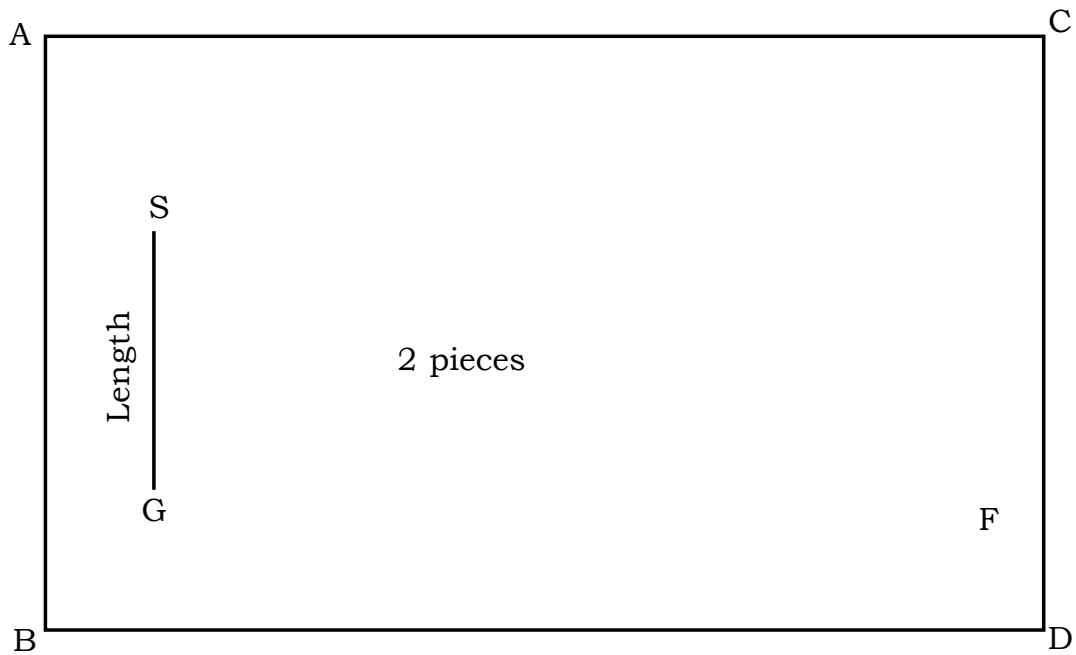
AC = BD =  $\frac{1}{2}$  twice waist circumference

SG = length wise

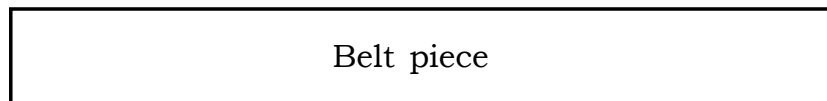
### Pattern pieces



**Fig. 1**



**Fig. 2**



**Fig. 3**

Front part piece – 1

Back part piece – 1

Waist belt piece – 1

**Stitching method**

1. Cut the skirt part leaving allowances for fold.
2. Join 2 pieces in length wise direction.
3. Join the left side with small open for placket.
4. Stitch the pleats to the desired waist size.
5. Finish the waist line with the waist belt of desired size.
6. Join the side line seams.
7. Measure the length of the dress and finish the bottom edges.
8. If necessary, attach pocket on side line, use hooks and eyes on the placket.
9. Press and iron.

## 5. PLAIN BLOUSE (FOR SKIRTS)

### Introduction:

This blouse is suitable for ordinary gathered skirts and half skirts. This blouse is worn by girls of all ages. Sleeve can be short or long size as desired by us.

**Suitable materials:** Cotton, silk, velvete, 2/2, voiles, huckobha, fancy materials can be used.

**Fabric requirements:** Twice dress length + sleeve length + 10 cms for fold

### Measurements

Length = 15"

Chest = 24"

Shoulder width = 11"

Sleeve circumference = 10"

Sleeve length = 6"

### Instruction for drafting (Front Part)

ABCD is a rectangle

AB = CD = length + 1½" fold

AC = BD = ¼ chest width + ½" for ease

AE = Front neck depth = 3"

AF = Neck width = 2½"

AG = ½ shoulder width

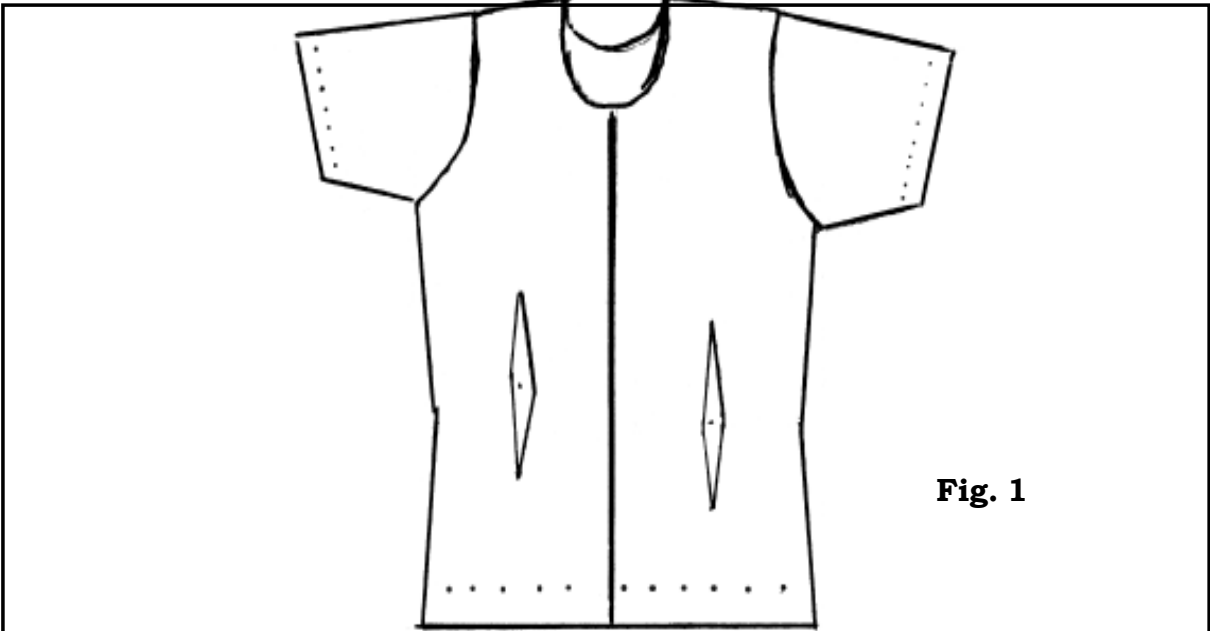
GH = ½ upper arm circumference.

HD = Divide this equally and mark I at the centre.

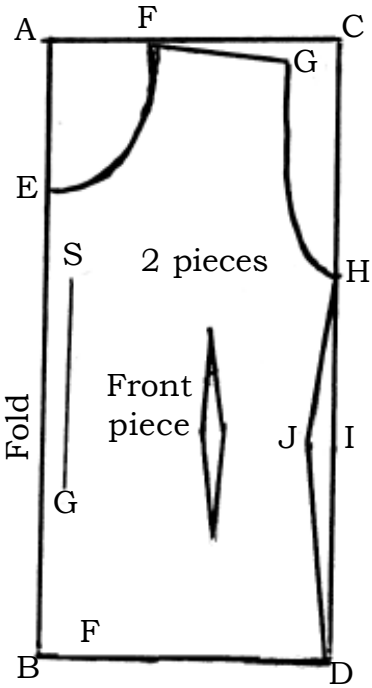
IJ = ½" HJD = side line

EFGHJDBE = Front part piece

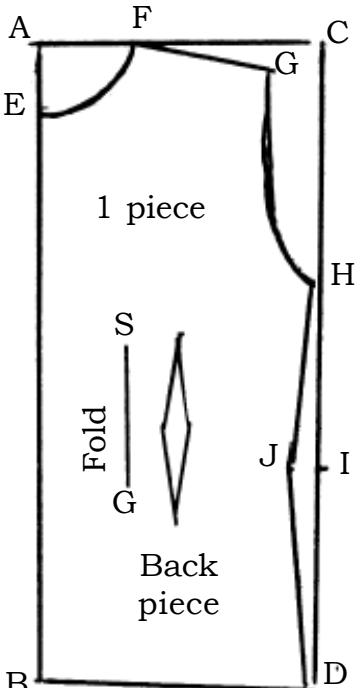
SG = Length wise.



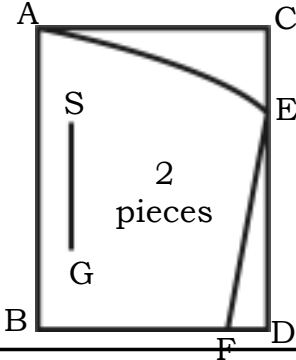
**Fig. 1**



**Fig. 2**



**Fig. 3**



**Fig. 4**

### **Back Part**

AB	=	CD = length + 1½” fold
AC	=	BD = ¼ chest width + ½” for ease
AE	=	Back neck depth = 1½”
AF	=	Neck width = 2½”
AG	=	½ shoulder width
GH	=	½ upper arm circumference
HD	=	Divide equally and mark I at the centre.
IJ	=	½ <sup>s</sup> HJD = Side line
EFGHJDBE	=	Back part piece
SG	=	Length wise.

### **Sleeve Part**

AB	=	Sleeve length + 1” fold
AC	=	BD = ½ sleeve circumference
CE	=	1/ chest circumference
EF	=	Side line
DF	=	½”

### **Pattern Pieces**

- Back part piece – 1
- Front part piece – 2
- Sleeve pieces – 2
- Facing, binding pieces for placket open – 2
- Neck line cross pieces

### **Stitching Method**

1. Cut the fabric according to the pattern leaving seam allowances.
2. Join the shoulders of front & back pieces.
3. Stitch full length darts in front & back and finish the side seams.
4. In the front cut a lengthy placket and stitch facing and binding placket.
5. Finish the neck line with cross piece.
6. Attach the sleeves to the bodice part.
7. Fold the bottom edge and stitch.
8. Finish the blouse by attaching hooks and eyes or buttons on plackets.

### **Note :**

## 6. CHOLI

### Introduction:

This choli is best suited for aged women. This is from shoulder to waist. Waist band is attached at the bottom of the choli.

**Suitable materials:** Soft materials of white plain or coloured cotton, voiles, 2/2 fabrics can be selected.

**Fabric requirements:** Twice length of dress + sleeve length + 10 cms

### Measurements:

Length = 14"

Chest = 30"

Shoulder width = 13"

Sleeve circumference = 11"

Sleeve length = 8"

Waist circumference = 25"

### Instructions for Drafting

#### Front Part

ABCD is a rectangle

AB = CD = length + 1½" fold

AC BD = ¼ chest width

AE = Front neck depth = 4"

AF = Neck width = 3"

AG = ½ shoulder width

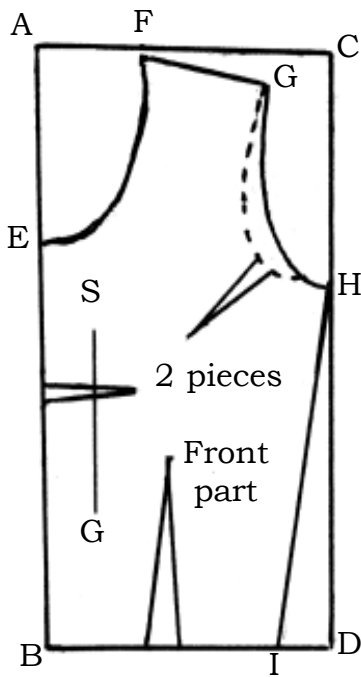
GH = 1/6 chest circumference + 1"

DI = 1"

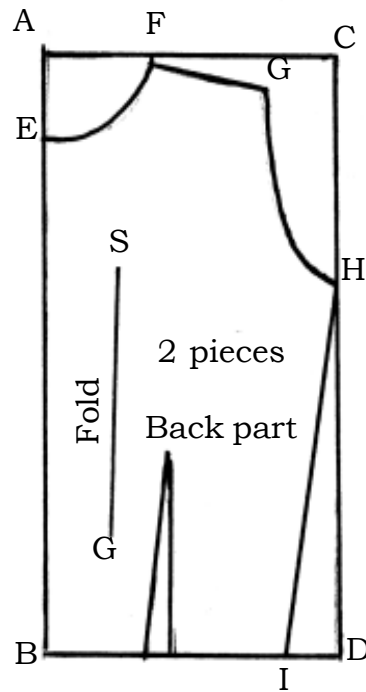
HI = Side line seam.



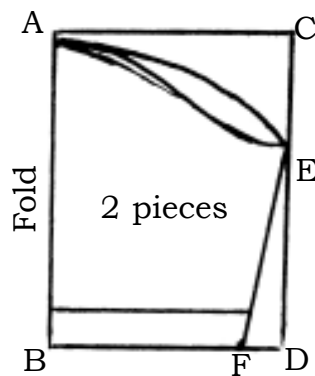
**Fig. 1**



**Fig. 2**



**Fig. 3**



**Fig. 4**



EFGHIBE = Front piece.

### **Back Part**

AB = CD length + 1½" fold

AC = BD = ¼ chest width + ½" for ease

AE = Back neck depth = 3"

AF = Neck width = 3"

AG = ½ shoulder width

GH = 1/6 chest circumference + 1"

DI = 1"

HI = side line seam

EFGHIBE = Back piece

### **Sleeve Part**

AB = Sleeve length + 1" fold

AC = BD = ½ sleeve width

AE = Curved part

CE = 2½"

EF = Side line seam

DF = 1"

SG = Length wise

### **Pattern Pieces**

Front part body piece – 2

Back part body piece – 1

Sleeve part pieces – 2

Placket and neck line cross piece, facing and binding pieces.

### **Stitching Method**

1. Cut the body and sleeve from the fabric according to the pattern leaving seam allowances.
2. Join front and back body parts and join shoulders.
3. As shown in the figure stitch 3 darts in the front piece and 2 half darts in the back piece.
4. Join the side lines.
5. Hem the sleeve bottom edges and join the side lines
6. Attach the sleeve to the body part and stitch.
7. At the front part stitch 2 piece placket ie., facing and binding.

8. In the waist part attach a 1½” waist band.
9. Finish the neckline with cross piece.
10. Use hooks & eyes on the placket to form closing.
11. Told the blouse and press

**Note :**

## 7. CUT CHOLI

**Introduction:** This is worn by women. This choli is used when wearing sarees. The choli should fit the body structure.

**Suitable materials:** Voiles, cotton, silk, velvete, printed silk, huckobha, umber, 2/2, materials can be used for cut choli.

**Fabric requirements:** Twice choli’s length + sleeve length + 5 cm fold.

### Measurements

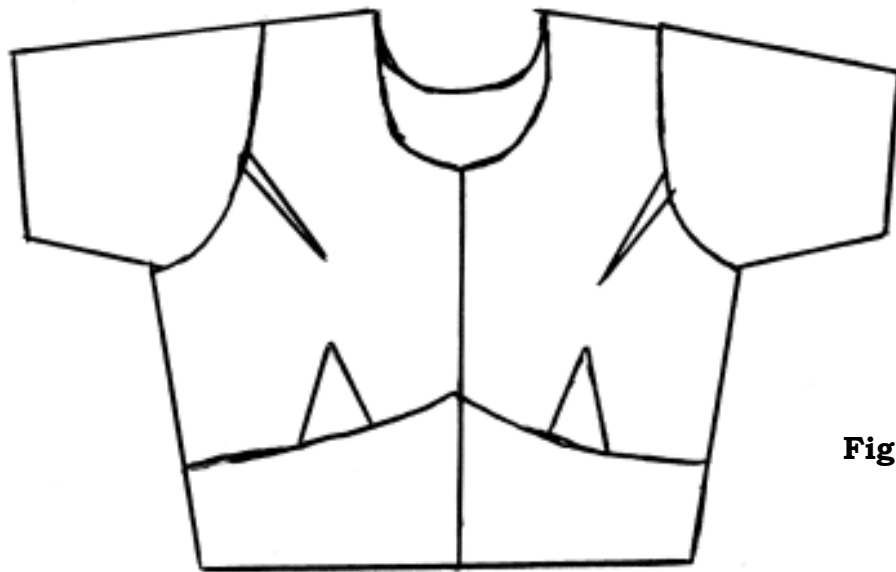
- Full length = 14” + 1½” fold
- Chest circumference = 30”
- Shoulder width = 13”
- Waist circumference = 25”
- Sleeve circumference = 11”
- Sleeve length = 8”

### Instructions for Drafting

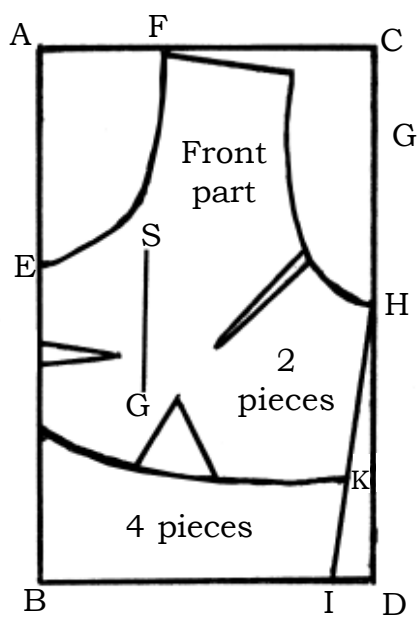
#### Front part

ABCD is a rectangle

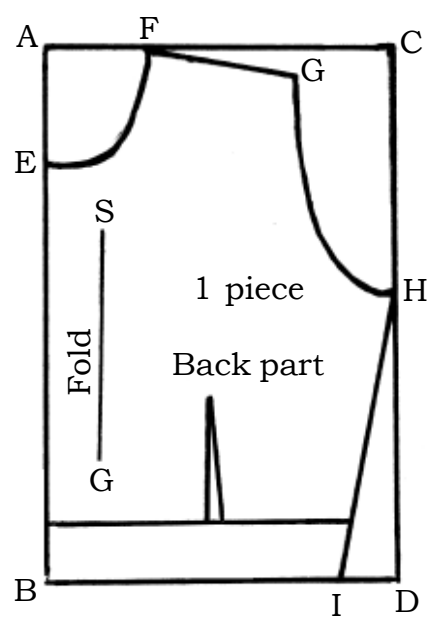
- AF =
- AB = CD = length + cross belt (patti)
- AC = BD = ¼ chest width + ½” for ease
- AE = Front neck depth = 4”
- AF = Neck width = 3”
- AG = ½ shoulder width
- GH = 1/6 chest circumference + 1”



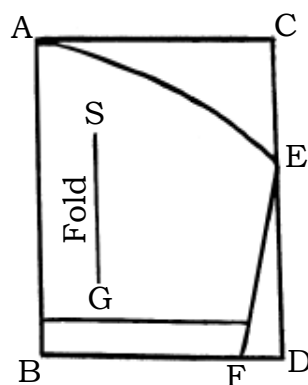
**Fig. 1**



**Fig. 2**



**Fig. 3**



**Fig. 4**

DI = 1"  
 JB = KI Belt piece (patti piece)  
 HKI = Side line seam.  
 EFGHLKJE = Front piece.  
 JKIB = Patti piece  
 SG = length wise

**Note:** Patti or belt cut from the front piece should again be attached to the front piece after stitching the front darts.

### **Back Part**

AB = CD length + 1½" fold  
 AC = BD = ¼ chest width  
 AE = Back neck depth = 2½"  
 AF = Neck width = 3"  
 AG = ½ shoulder width  
 GH = ¼ chest circumference + 1"  
 DI = 1" HI = side line  
 SG = Lengthwise  
 EFGHIBE = Back part piece

### **Sleeve Part**

AB = CD = Sleeve length + 1" fold  
 AC = BD = ½ sleeve circumference  
 CE = 3"  
 EF = Side line  
 DF = 1"  
 SG = Length wise

### **Pattern Pieces**

Front part body piece – 2

Cross belt (patti ) 4 pieces

Back part body piece – 1

Sleeve part – 2 pieces

Placket and neck line cross piece, facing and binding pieces.

### **Stitching Method**

1. Cut the material using paper pattern leaving seam allowances on the bodice front, back and sleeve.
2. Cut the belt from the bodice front & fold the bottom and do the machine stitch.
3. Stitch 3 darts in the front part on both sides (left & right) as shown in the figure.
4. Now attach the belt to the front part of the bodice.
5. Near the opening do the 2 piece placket.
6. After attaching the placket, attach the front bodice to the back at the shoulder seam.
7. On the back bodice do the 2 half darts.
8. After joining the shoulder seam join the side seams.
9. Take 2 sleeve parts, fold the edges and do the hemming.
10. After hemming, attach the sleeves to the bodice.
11. Finish the neck line using cross pieces and do the hem.
12. After finishing the neck, attach hooks and eyes near the opening (or on the placket).

### **Note :**

## PRACTICAL II

### 1. SHORTS

#### Introduction

This dress is generally worn by school going children. The belt is usually stitched along the waist line for shorts. Shorts is worn above the knee, hence it is used as a sports wear. Pockets are stitched along the sides on both sides.

#### Suitable materials

Thick materials like binny, khaki, terrene, terry cotton are suitable for shorts.

#### Fabric requirements

90" width material full length + fold

If width is short - Twice the length of short + fold

#### Measurements

Length - 10" + 2" for fold

Seat width - 32"

Front seat - 14"

Backseat - 18"

Belt length - 1½"

Placket length / open length - 6"

#### Instructions for Drafting

##### Front part

ABCD is a rectangle

AB = CD = length + fold 2"

AC = BD  $\sqrt{2}$  front seat + ½ for ease

CE = 1"

CF = Placket length 7½

Draw a parallel line GH above BD

GH = ½"

FH inside leg length

DG = 2"

GB = GH Fold 8B cut

SG = length wise.

AEFHDBGGA - Front piece.

### **Back part**

ABCD is rectangle

AB = CD = length + fold 2"

AC = BD =  $\frac{1}{2}$  back seat

CE = % of back seat width (  $\frac{1}{2}$ " for ease).

CF = back curve 7 $\frac{1}{2}$ "

Draw a parallel line GH above BD measuring

GH =  $\frac{1}{2}$ "

FH = Inside leg length

From point E back raise, EI = 1"

From I join back curve to A.

**Note:** Back section of the shorts will be in slightly raised position.

1. Cut 5 open pieces for placket.
2. Fold the square pieces and stitch the pockets as shown in the figure.
3. According to the waist measurement attach the belt.
4. On the front open do button and button hole.

### **Pattern pieces:**

Front pieces - 2

Back pieces - 2

Open pieces - 5

Placket piece - 1

Belt piece - 1



Fig. 1

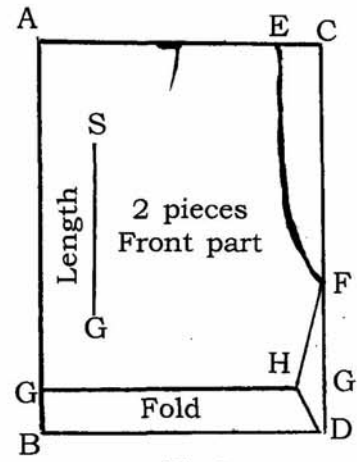


Fig. 2

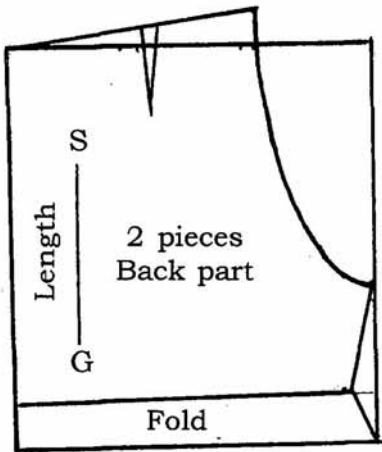


Fig. 3

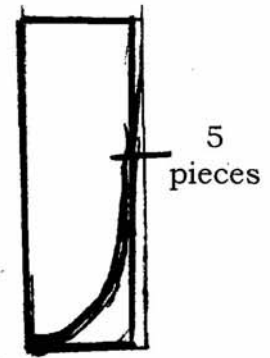


Fig. 4

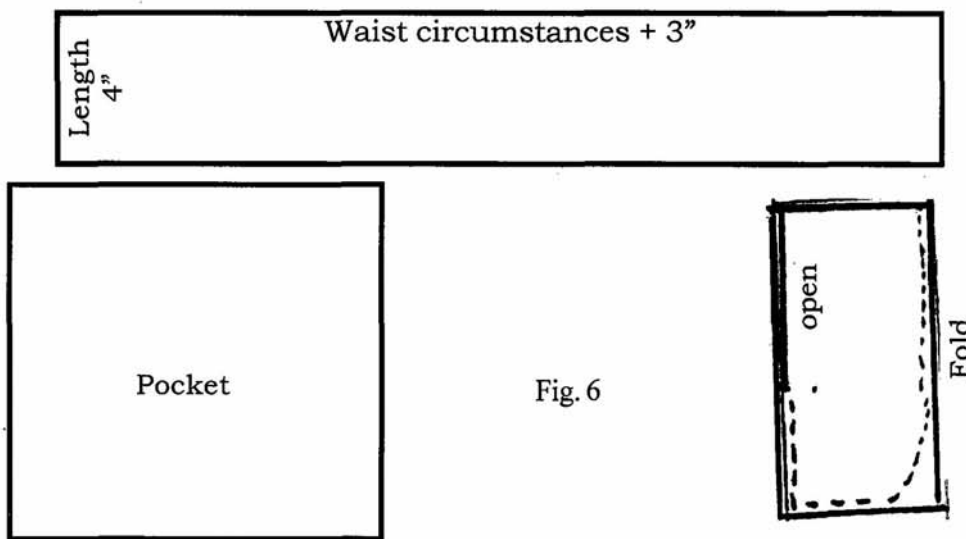


Fig. 6



### **Stitching Method**

1. Place the pattern pieces on the material. Leave seam allowances for side seam, front pleats, back darts and cut the pattern pieces.
2. Join the pocket piece along the front and back pieces of the short on both sides (right 8s left side)
3. On the front piece stitch the pleats and on the back piece. Stitch the darts.
4. Join the inside leg seam and do the run and fell seam. On the right and left sides. Left overlapping the right section of the facing and binding and finish the opening.
5. After joining the back curve attach the belt.
6. Finally fold the leg bottom edges and do the stitching. Now press and iron.

### **Remarks:**

The difference between any body measurement and the actual garment measurement is called ease.

## 2. T-SHIRT

### Introduction

This can be worn by all age groups of men. It is a comfortable wear. In western countries, this garment is used by women. Nowadays, in our country also women wear it. This garment can be stitched with or without yoke. At the neck line, straight collar or tennis collar can be attached.

### Suitable Material

Polyester, Cotton, Terycotton, Spun

### Material Required

Twice the length of garment and sleeve length +10" required material.

### Measurements

Chest circumference	=	26"
Height	=	17"
Back width	=	10"
Upper arm circumference	=	10"
Sleeve length	=	5"

### Drafting Procedure

#### Front Part

ABCD = Rectangle

AB=CD=length+1½" fold

AC = BD = ¼ Chest circumference + front open fold allowance + Vz" ease allowance

AE = Front neck depth = 2"

AF = Neck line width = 2"

AG = ½ Shoulder width

GH = ½ Upper arm circumference

HD = Divide equally and name it as I.

IJ = ½ EFGHJDB = Front piece

HJD = Side seam

S.G = lengthwise

### **Back Pattern**

AB = Length + Fold 1½"  
AC = BD = ¼ Chest circumference + ½" for ease  
AE = Back neck depth 1½ "  
AF = Neck line width 2"  
AG = ½ Shoulder width  
GH = ½ Upper arm circumference  
HD = Divide equally and name it as I  
IJ = ½"  
HJD = Side seam  
S.G. = Lengthwise  
EFGHJDB = Back piece

### **Sleeve**

AB = Sleeve length + Fold  
AC = BD = ½ upper arm circumference + ½" ease  
CE = 2"                      DF = 1"  
BF = Front arm circumference  
EF = Side seam

### **Collar**

AB = CD = Collar length 3"  
AC = BD = Collar width .  
DF = 1"                      AE = ½"

### **Required pieces**

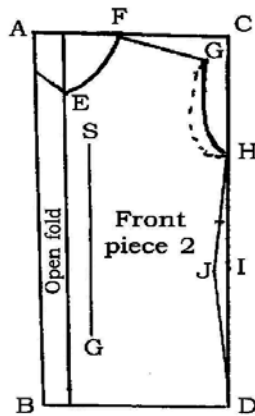
Front pieces = 2  
Back piece = 1  
Sleeves = 2  
Collar pieces = 2

### **Stitching Method**

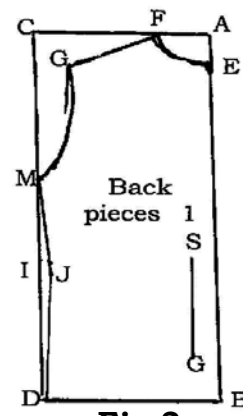
1. According to pattern, leaving seam allowance, space for stitching the required number of pieces front and back part, sleeve and collar, pocket should be cut and kept read for stitching.
2. Attach front and back and join shoulder seams.
3. Attach the pocket at the left side of front piece.



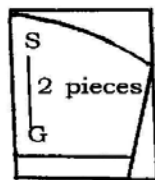
**Fig.1**



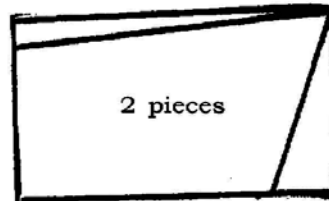
**Fig.2**



**Fig.3**



**Fig.4**



**Fig.5**

4. Join the side seams.
5. Stitch the hem line of the sleeve and attach the side seam of the sleeve.
6. Prepared sleeves are attached to the shoulder part.
7. Except the centre neck portion of the collar attach the other portion.
8. Now turn the cotton to right side. Attach collar to the neck line. Complete the hem lines
9. Complete buttons and button holes and Iron the garment.

### 3. PYJAMA

#### Introduction

This can be worn by all age groups of men for bottom wear. It is used as night time wear. This is a traditional dress for Andhra Pradesh. It will be stitched with ordinary open or fly open. This garment can be stitched with elastic or a chord. This is a comfort wear for men.

#### Suitable Material

Cotton, Kaadha, Voiles, Khadhar

#### Material Required

Suitable for 5 year children

Twice the length of garment length + fold - 1 meter to 1 1/2 meter cloth.

#### Measurements

Length of the garment = 22" + Hip folding and leg folding = 4" = 26"

Seat circumference = 32"

#### Procedure

ABCD = Rectangle

AB = CD = length + bottom fold + Hip belt

AC=BD = 1/4 part of the seat circumference

CE = 1"

CF = 1/3 part of the length

DG = 2"

FG = Side seam

BG = Front leg circumference

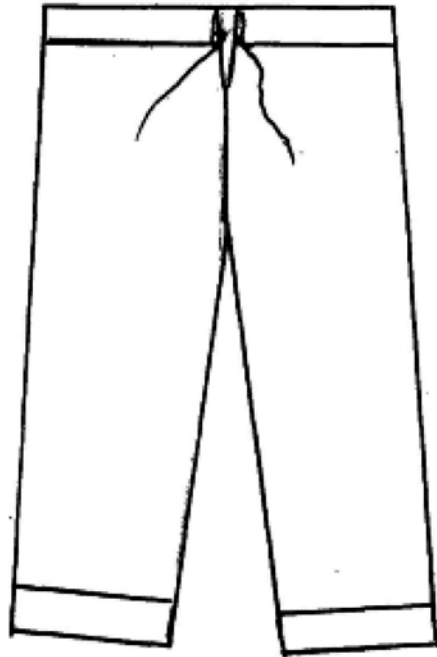
AEFGBA = Attach the front and back part.

S.G = lengthwise

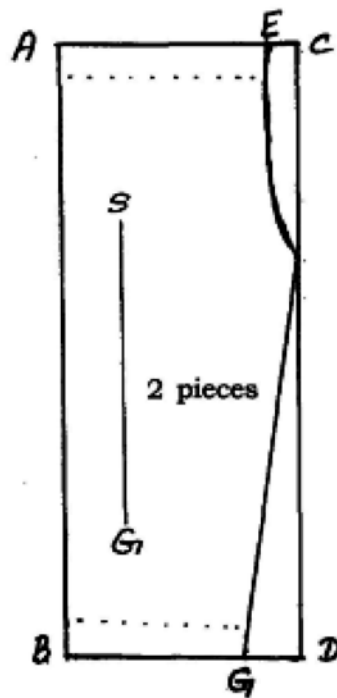
#### Stitching method

1. According to the pattern marking the space for stitching and folding cut the remaining part.
2. Fold bottom edges of the leg and stitch
3. Join the side seams of the leg parts separately and attach.

4. Join the right and left side open curve line and stitch french seam.
5. Allow space to insert the cord and the hip and stitch.
6. Finally insert the cord.



**Fig 1**



**Fig 2**

## 4. KALIDAR KURTA

### Introduction

Generally this dress is mostly preferred by North Indian males. Now-a-days this dress is worn by South Indian Males on festivals, occasions and normal days. This garment is constructed in white, yellow, sandal light materials in which embroidery work is done.

**Suitable materials:** Silk, polyester, linen, etc.

Soft materials like are best suited.

### Fabric requirements

Twice dress length + sleeve length, Additionally for others 8" of fabric is needed.

### Measurements for 4 to 5 years old boy

Length = 19"

Chest circumference = 26"

Sleeve length = 15"

Upper arm length = 10"

2" lengthy wide guesset (or kali) piece

### Instructions for Drafting

ABCD is a rectangle

AB = CD = length + bottom fold 1"

AE = neck width 2"

AF = back neck depth 1W

AG = front neck depth 3"

AC =  $\frac{1}{2}$  shoulder width

CH =  $\frac{1}{2}$  upper arm length

ABCD = side joining piece

AC = 1 $\frac{1}{2}$ " BD = 3"

### Sleeve part

AB = sleeve length + 1" fold

AC =  $\frac{1}{2}$  upper arm length

DE =  $\frac{1}{2}$ "

CE = Sleeve side line

BE = front arm circumference.

Joint side seam, attach sleeve to body. Then attach gusset or Kali piece to the arm hole and stitch. On the left side of the garment pocket should be stitched.

**Pattern pieces**

Back part piece - 1

Front part piece - 1

Sleeve pieces - 2

Side join pieces - 4

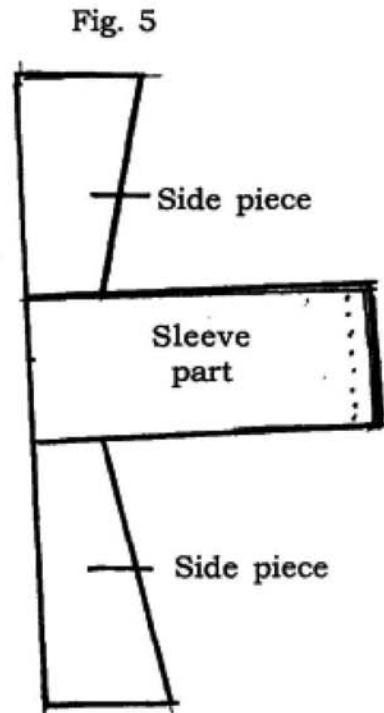
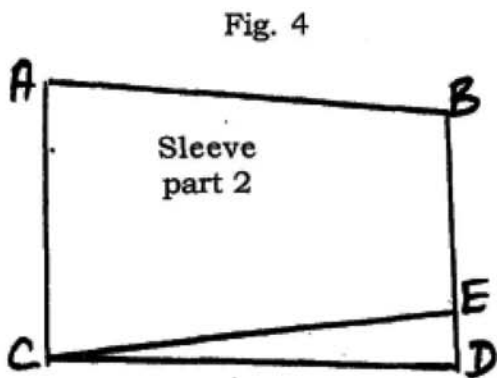
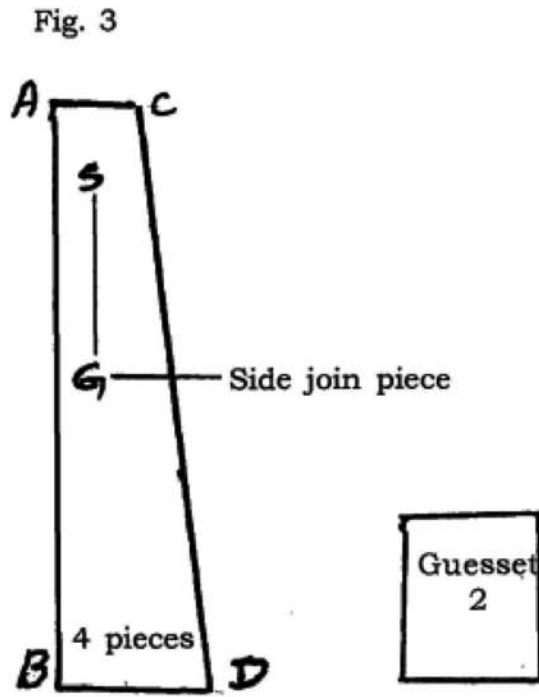
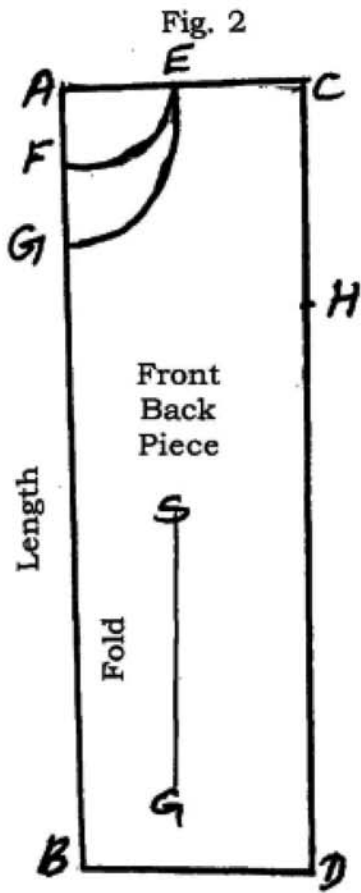
To stitch a continuous placket in the front - a piece

Neck line piece - cross pieces



**Fig 1**





### **Stitching method**

1. According to the pattern, leave seam allowances and cut the fabric.
2. Stitch run and fell seam on the shoulder of front & back parts.
3. Side line joints should be attached to the sleeve as shown in the figure.
4. Attach with the body.
5. Fold the gusset or kali piece and keep it on the arm hole and stitch it.
6. On the front neck portion cut open a miter placket or continuous placket and stitch.
7. Finish the neckline, using a cross piece.
8. Bottom edges of sleeves and body should be folded and stitched.
9. When stitching the side seams open 2" must be stitched.
10. The garment is pressed and ironed.

## 5. SALWAR

### Introduction

Indian girls are wearing salwar kameez for many years, Now a days various styles are produced from normal salwar. Among them various styles like pattiya is most preferred by girls. Waist belt is attached with salwar for comfortable wear.

### Suitable Materials

Cotton, polyester, fancy material, mirror work material.

### Material Required

2 meter or 2½ meter, according to the length of garment.

### Measurement

Suitable for 15 year girls.

Height = 39" + 2" allowance

Seat circumference 60"

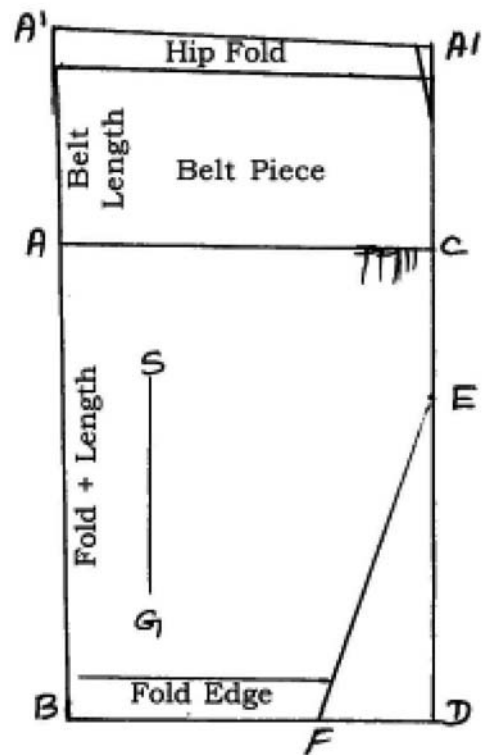
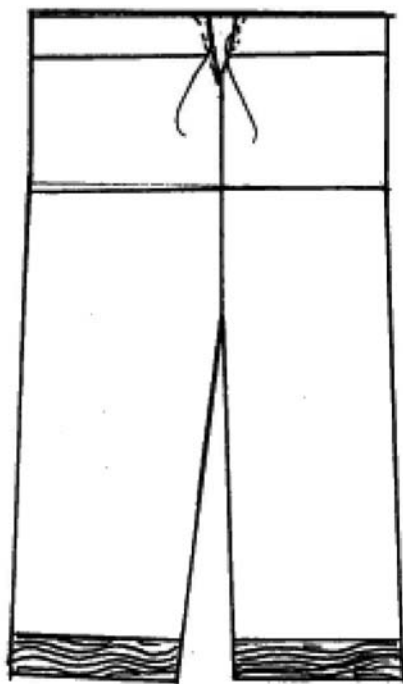
### Procedure

- ABCD = Rectangle
- AB = CD = Length - hip belt
- AC=BD = ¼ Part of the 15" seat circumference.
- CE = 5"
- EF = Leg side seam
- BF = ½ part of BD
- A<sup>1</sup>, A-A<sup>1</sup>, C = Cord piece length
- A1 = Draw straight line as AC
- ACEDBA = Seperate piece
- A A<sup>1</sup>,A1C = belt piece.
- S.G. = lengthwise

### Required Pieces

Cut belt piece as pattern in diagram 1

Cut piece as pattern (not attached to belt) - 2



### Stitching Method

1. According to the pattern mark the space for stitching and folding and cut the remaining part.
2. Join the leg side seam.
3. Finish the bottom hem.
4. Attach the belt piece with the bottom piece.
5. Stitch the piece correctly for insert the cord.
6. Insert the cord."
7. While attaching the hip belt with bottom piece stitch some pleats for comfort.

## 6. KAMEEZ

### Introduction

Kameez is the garment worn by Indian women from olden days. Salwar kameez is designed according to the latest trend and is an important wear used by ladies. This garment is a comfortable wear and looks very beautiful. The long loose, comfortable top is called 'kameez' is derived from latin word 'Kameezia.'

### Suitable materials

Cotton, muslin, silk, fancy materials are best suited.

### Fabric requirements

Twice the length of the dress + sleeve length

### Measurements

Length = 30"

Chest circumference = 26"

Upper arm circumference = 10"

Shoulder width = 9"

Waist circumference = 20"

Sleeve length = 6"

### Instruction for Drafting

#### Front part

ABCD is a rectangle.

AB = CD = length + fold  $\frac{1}{2}$ "

AC = BD =  $\frac{1}{4}$  chest circumference +  $\frac{1}{2}$ " for ease

CE = front neck depth = 3"

AF = neck width = 2"

AG =  $\frac{1}{2}$  shoulder width

GH =  $\frac{1}{2}$  upper arm circumference

HI =  $\frac{1}{2}$  chest circumference

IJ = 1" IK =  $\frac{1}{4}$  chest circumference

D-D1 = 2"

H,J,K D1 - side line seam

D1-L 1"

EFGHJKL,D1,DBE front part.

SG= length wise

GH - front arm hole

### **Back part**

ABCD is a rectangle

AB = CD = length + fold

AC = BD =  $\frac{1}{4}$  chest circumference +  $\frac{1}{2}$ " for ease

AE = back neck depth 1  $\frac{1}{2}$ "

AF = neck width 2"

AG =  $\frac{1}{2}$  shoulder width

GH =  $\frac{1}{2}$  upper arm circumference

HI =  $\frac{1}{4}$  chest circumference

IK =  $\frac{1}{4}$  chest circumference

IJ = 1"

HJK - D1 side line seam

D1-L= 1"

EFGHJKLDBE = back part

SG = Lengthwise

### **Sleeve part**

AB = CD sleeve length + fold 1"

AC = BD =  $\frac{1}{2}$  upper arm circumference +  $\frac{1}{2}$ " for ease

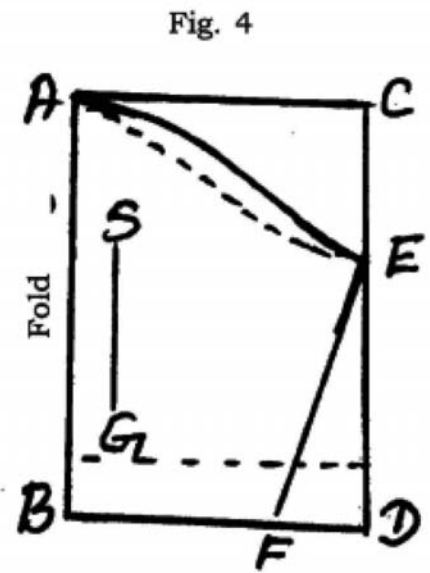
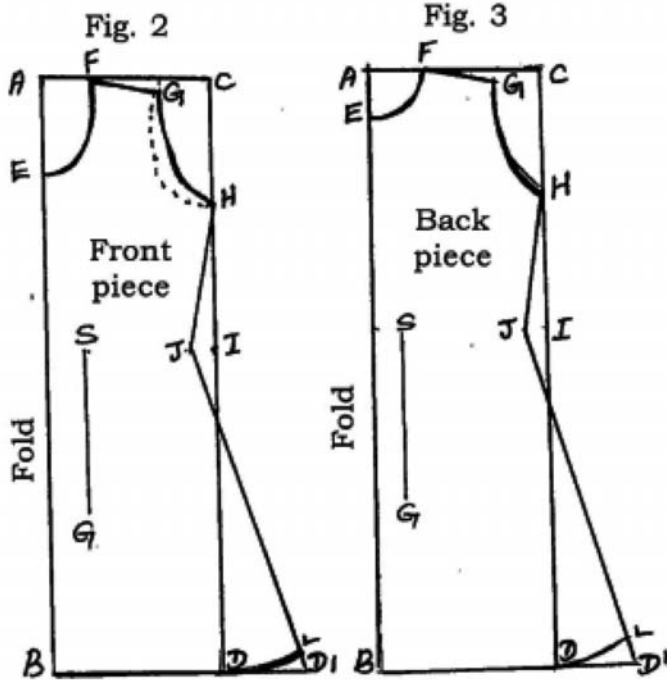
CE = 2"

DF= 1"

FB = Front arm circumference



Fig. 1



EF = side line seam

AE = curve line arm hole

AEFBA = sleeve part

### **Pattern pieces**

Back part piece - 1

Front part pieces - 2

Sleeve part pieces - 2

Placket, neck line pieces - as required.

### **Stitching method**

1. Use pattern and cut the parts of the dress from the fabric.
2. Join shoulders of front & back parts.
3. In the front and back parts stitch Vz darts.
4. In the slit opening placket attach facing and binding pieces.
5. Join the side line seams.
6. In the waist 1½" waist belt should be stitched.

### **Sleeve part**

7. Do the hemming at the bottom sleeve edge.
8. Join side line seams of the sleeve.
9. Attach the prepared sleeve to the body part.
10. Finish the neck line with cross piece or else do the piping.
11. As shown in the figure stitch KL as the opening.
12. Finished dress is pressed and ironed.



## 7. SLACK SHIRT

### Introduction

This can be worn by all age groups. Sleeve length starts from shoulder point to cuff. In the end of the sleeve there is a cuff and opening. The neck band collar is attached and then the left side is stitched with a pocket. The slack shirt gives fit and comfortness for the wearer.

### Suitable Material

Cotton, silk, polyester, terene and spun.

### Material required

The required material for the slack shirt is thrice the length of the garment and 8" only.

### Measurements

length	= 22"	Chest circumference	= 24"
Back Width	= 10"	Upper arm	= 10"
Sleeve length	= 15"	Yoke length	= 3"

### Drafting Procedure

#### Front Pattern

AB=CD	=	length + $\frac{1}{2}$ fold allowance
AC	=	BD $\frac{1}{4}$ " part of chest circumference + $\frac{1}{2}$ " for ease
A <sub>1</sub> , A	=	open fold width
A <sub>1</sub> , B <sub>1</sub>	=	Open fold length
AE	=	Front neck depth 2" 5
AF	=	Neck line width 2" 5
AG	=	$\frac{1}{2}$ part of shoulder width
GH	=	$\frac{1}{2}$ part Upper arm circumference
HD	=	Divide equally and name it as I.
IT	=	$\frac{1}{2}$ ", DK=I"
SG	=	lengthwise
A <sub>1</sub> , E,FGHJKB, B <sub>1</sub>	=	Front part

### Drafting Procedure

#### Back Pattern

ABCD	=	length + $\frac{1}{2}$ " fold allowance
AC	=	BD chest circumference + $\frac{1}{2}$ " ease
CE	=	Shoulder $\frac{1}{2}$ part back width
EF	=	Armhole

FB	= Divide equally and name it as G
GH	= $\frac{1}{2}$ Divide equally and name it as G
FHB	= Side seam
SG	= lengthwise
CEFGBD	= back part

**Note:**

Due to the yoke attachment in back part of the shirt, there should be less than 1" in back side than in the front part.

**Drafting Procedure**

**Yoke Pattern**

ABCD	= Yoke length 3"	AC, BD	= Yoke width + $\frac{1}{2}$ " for ease
AC	= $\frac{1}{2}$ part Yoke width	CE	= Back neck depth 1"
CF	= Neck width 2"	FC	= shoulder part

**Drafting Procedure**

**Sleeve Pattern**

AB	= Sleeve length
AC	= $\frac{1}{2}$ part Upper arm circumference + $\frac{1}{2}$ " part
CE	= 3"
AE	= Armscye circumference
AE	= Armscye depth
DF	= 2"
EF	= Sleeve side seam
BB1 FF1	= Cuff length (2 folds)
B1, F1	= Wrist circumference

**Drafting procedure**

**Neckband Collar pattern**

ABCD	= Collar length
AE	= $\frac{1}{2}$ " DF = 1"
ECFB	= Collar part
BG, DH	= Neck band length
BD, GH	= $\frac{1}{2}$ of neck circumference
DI	= $\frac{1}{2}$ "

**Pattern Required**

Front part pieces	= 2
Back part piece	= 1
Yoke part	= 2
Sleeve part	= 2
Collar, neck band	= 2+2
Pocket	= 1



Fig. 1

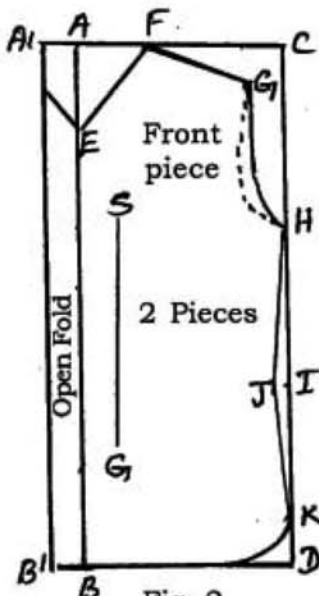


Fig. 2

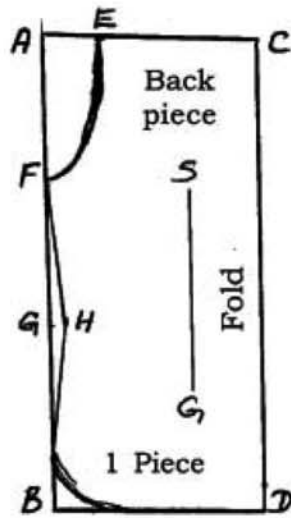


Fig. 3

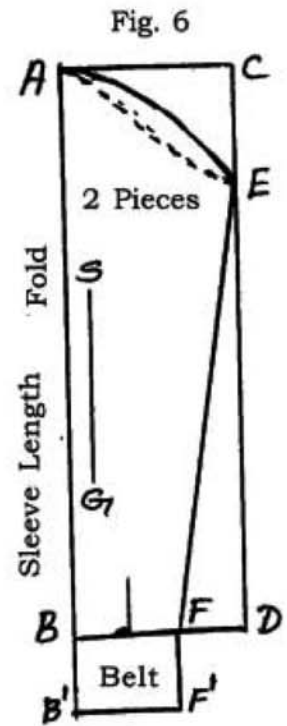


Fig. 6

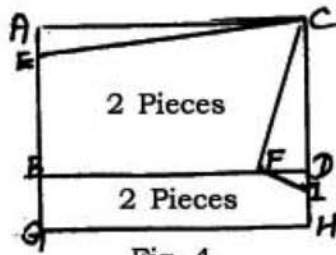


Fig. 4

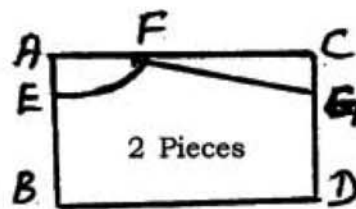


Fig. 5

### **Stitching method**

1. According to the pattern, front and back, yoke and sleeve, collar and pocket patterns and cuttings should be kept ready.
2. Attach yoke to the back part.
3. Then join the shoulder seams.
4. Attach pocket to the left side.
5. Join the side seams.
6. Finish sleeve hems make continuous open placket or mitter placket and stitch suitable cuff with double cloth and stitch.
7. Attach the sleeves to the shoulder lines armhole and finish side seams and hem line.
8. Fold bottom and stitch
9. Prepare neckband collar and attach collar to the neck line following the instructions for applying convertible collar.
10. Complete button and button holes.
11. Iron and fold the shirt neatly.

**PRACTICALS I**  
**QUESTIONS**

1. Do Drafting, paper cutting and stitch a Magyar frock for a 3 year old girl
  - a) hem the sleeve and neck line.
  - b) do facing and binding in back open and attach hooks and eyes.
  
2. Do Drafting, paper cutting and stitch a yoke frock for a 2 year old girl.
  - a) attach puff sleeve on the armhole part
  - b) Do facing and binding in back neck open and attach hooks and eyes.
  - c) stitch one flower embroidery in the chest part.
  
3. Do Drafting, paper cutting and stitch a round yoke frock for a 3 year old girl.
  - a) attach designed sleeve in the armhole parts.
  - b) attach round skirt to the waist part
  - c) Do facing and binding or zip open at the back open part.
  
4. Do Drafting, paper cutting and stitch a half skirt for a 5 year old girl
  - a) stitch 1 ½ “ band at the waist part and attach hooks and eyes at the placket.
  - b) stitch ordinary pleats or box pleats to the skirt part.
  
5. Do Drafting, paper cutting and stitch a plain blouse for a 3 year old girl.
  - a) hem the sleeves and neck lines.
  - b) cut a lengthy placket in the front part and stitch facing and binding. Attach hooks and eyes to it.
  
6. Do Drafting, and paper cutting and stitch a suitable choli for a 50 year old woman.
  - a) hem the neck line and sleeve.
  - b) stitch necessary darts in front and back pieces.
  - c) attach hooks and eyes in the front open part
  
7. Do Drafting, paper cutting and stitch a suitable choli for a 20 year old woman.
  - a) stitch cross belt and darts in the front part
  - b) hem the neckline and sleeves.

## **PRACTICALS II**

### **QUESTIONS**

1. Do Drafting, paper cutting and stitch a shorts for a 10 years old boy.
  - a) Stitch pockets on both sides.
  - b) In the front open part provide fly open.
  - c) In the waist piece attach bet.
2. Do Drafting, paper cutting and stitch a T-shirt for a 3 year old boy.
  - a) hem the bottom of shirt and sleeve.
  - b) Attach pocket at left side of front piece.
  - c) On the part complete buttons and button holes.
3. Do Drafting, paper cutting and stitch a pyjama for a 4 year old boy.
  - a) Stitch with chort on the waist.
  - b) when folding the bottom give a lining material.
4. Do Drafting, paper cutting and stitch a akalidhar Kurtha for a 5 year old boy.
  - a) hem the bottom edges of sleeve also fold the neckline and hem.
  - b) stitch pocket on the right side
  - c) stitch mitter placket on the front neck.
5. Do Drafting, paper cutting and stitch a chudidhar bottom for a 5 year old girl.
  - a) give lining material and fold the bottom and stitch.
  - b) Insert chord in waist band
6. Do Drafting, paper cutting and stitch a Kameez for a 5 year old girl.
  - a) hem the sleeve, bottom, and neckline
  - b) Do facing and bind in the back part
7. Do Drafting, paper cutting and stitch a slack shirt for a 5 year old boy.
  - a) Attach yoke and full hand sleeve to the back part
  - b) Attach neck band collar at the neck part
  - c) Attach patch pocket on the left side
  - d) In the front open complete button and button holes.

### **REFERENCES FOR TEXTILE FINISHES**

1. Corbman B.P. Fibre to Fabric, International Students Edition Mc Graw Hill Book Co-Singapore, 2000.
2. J.L. Smith, Textile Processing, Abhishek Publications, Chandigarh, 2003.
3. Gokarneshan N, Fabric Structure and Design, New age International Publishers 2004.

### **REFERENCES FOR DYEING AND PRINTING**

1. Kate Wells, Fabric Dyeing and Printing, Conran Octopus 2000.
2. C.W. Pellow, Dyes and Dyeing, Abhishek Publications, 2000.
3. Z.J. Grosicki, Watson's design and Colour-Elementary Weaves and Figured fabrics. Wood health publishing limited, 2004.

### **REFERENCES FOR PATTERN MAKING AND DRESS DESIGNING**

1. Betsy Hosegood, The Complete Book of Sewing, Dorling Kindersley Ltd., London, 2006.
2. Chris Jefferys, 101 Essential Tips-Basic Sewing D.K. Publishing, 2004.
3. Premalatha Mullick, Garment Construction Skills, Kalyani Publisher, Ludhiana, 2002.

### **REFERENCE FOR COMPUTER**

1. Manuals of CAD/CAM software - Tukatech, Lectra, Gerber, 2000.
2. Kathleen Colussey M., Fashion design on computers, N.J. Prentice Hall upper Saddle River, New Jersey, 2000.
3. Alison Beazley Terry bond, Computer aided pattern design and product development, Black Wele, Amazon, 2003.

### **REFERENCES FOR FASHION MARKETING**

1. Sumathi, G.J. Elements of Fashion and Apparel Design, Oscar Publications, New Delhi. 2007.
2. V.D. Dudeja, Professional Management of Fashion Industry, Gangandeeep Publications, New Delhi, 2005.
3. Kitty G Dickerson, Inside the Fashion Business, Pearson Education, Singapore, 2003.